

AA Series Spray Gun

311001J

EN

For air-assisted spraying and finishing of paints and coatings.



Important Safety Instructions:

Read all warnings and instructions in this manual. Save these instructions.

See page 2 for **List of Models** and **Table of Contents**.

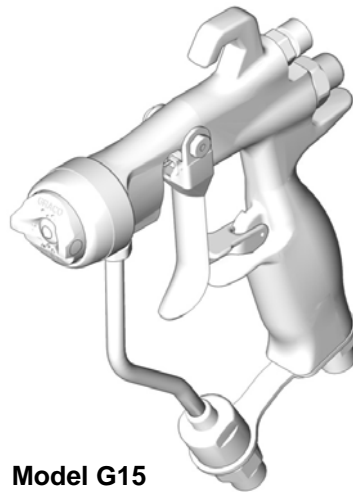

Model G15

T16553A

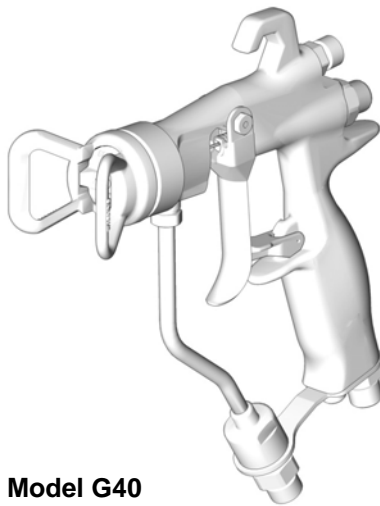

Model G40

T16844A

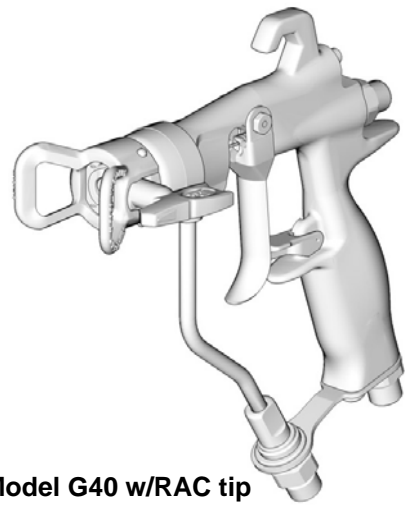

Model G40 w/RAC tip

T17204B

PROVEN QUALITY. LEADING TECHNOLOGY.

Contents

Models	2	Clearing a clogged RAC tip	16
Related Manuals	3	Troubleshooting	18
Warnings	4	General Troubleshooting	18
Installation	6	Repair	20
Typical Installation	6	Items Needed for Service	20
Grounding	6	Repair Kits	20
Air Line	7	Fan Valve Replacement	20
Fluid Line	7	Complete Gun Packing Repair	20
Setup	8	Disassembly	20
Flush Before Using Equipment	8	Seat Repair 20	
Select a Spray Tip and Air Cap	8	Needle Repair 21	
Install a Spray Tip	8	Air Valve Repair 22	
Position the Air Cap	8	Fluid Tube Replacement 22	
Air Cap Alignment Pin	8	Reassembly	24
Operation	10	Parts	26
Safety	10	Parts	28
Pressure Relief Procedure	10	Spray Tip Selection Chart	30
Trigger Lock	10	AAM Fine Finish Spray Tips 30	
How the Air-Assisted Spray Gun Operates . . .	11	GG4 Industrial Spray Tips 30	
Spray Pattern Adjustment	11	LTX RAC Spray Tips 31	
HVLP Operation	12	FFT Fine Finish RAC Spray Tips 32	
Fluid Application	12	WRX WideRAC Spray Tips 32	
Daily Gun Care, Flushing, and Cleaning	13	Accessories	33
General System Maintenance	14	Technical Data	34
Fluid Filter Maintenance	14	Dimensions	35
Flushing and Cleaning	14	Graco Standard Warranty	36
Reverse-A-Clean® (RAC) Tip	16	Graco Information	36

Models

Part No.	Series	Maximum Working Air Pressure psi (MPa, bar)	Maximum Working Fluid Pressure psi (MPa, bar)	Description	Includes:
288844	A	100 (0.7, 7.0)	1500 (10.5, 105)	G15 Medium Pressure Air-Assisted Spray Gun, Plastic Seat, SST Ball	249596 Air Cap
287926	C	100 (0.7, 7.0)	1500 (10.5, 105)	G15 Medium Pressure Air-Assisted Spray Gun, Carbide Seat and Ball	249596 Air Cap
249242	C	100 (0.7, 7.0)	4000 (2.8, 280)	G40 High Pressure Air-Assisted Spray Gun, Carbide Seat and Ball	249180 Air Cap
249246	B	100 (0.7, 7.0)	4000 (2.8, 280)	G40 High Pressure, High Flow Air-Assisted Spray Gun, Carbide Seat and Ball	249180 Air Cap
249238	A	100 (0.7, 7.0)	4000 (2.8, 280)	G40 High Pressure Air-Assisted Spray Gun, Carbide Seat and Ball, Reverse-A-Clean® (RAC) Tip	288465 RAC Air Cap





Related Manuals





This manual is available in the following languages:

Manual	Language
311001	English
311145	Chinese
311146	Danish
311147	Dutch
311148	Finnish
311149	French
311150	German
311151	Italian
311152	Japanese
311153	Korean
311154	Norwegian
311155	Polish
311156	Russian
311157	Spanish
311158	Swedish

Warnings

The following are general warnings related to the setup, use, grounding, maintenance, and repair of this equipment. Additional, more specific warnings may be found throughout the body of this manual where applicable. Symbols that appear in the body of the manual refer to these general warnings. When these symbols appear throughout the manual, refer back to these pages for a description of the specific hazard.



 WARNING	
	<p>FIRE AND EXPLOSION HAZARD</p> <p>Flammable fumes, such as solvent and paint fumes, in work area can ignite or explode. To help prevent fire and explosion:</p> <ul style="list-style-type: none"> • Use equipment only in well ventilated area. • Eliminate all ignition sources; such as pilot lights, cigarettes, portable electric lamps, and plastic drop cloths (potential static arc). • Keep work area free of debris, including solvent, rags and gasoline. • Do not plug or unplug power cords, or turn power or light switches on or off when flammable fumes are present. • Ground all equipment in work area. See Grounding instructions. • Use only grounded hoses. • Hold gun firmly to side of grounded pail when triggering into pail. • If there is static sparking or you feel a shock, stop operation immediately. Do not use equipment until you identify and correct the problem. • Keep a fire extinguisher in the work area.
 	<p>SKIN INJECTION HAZARD</p> <p>High-pressure fluid from gun, hose leaks, or ruptured components will pierce skin. This may look like just a cut, but it is a serious injury that can result in amputation. Get immediate surgical treatment.</p> <ul style="list-style-type: none"> • Do not point gun at anyone or at any part of the body. • Do not put your hand over the spray tip. • Do not stop or deflect leaks with your hand, body, glove, or rag. • Do not spray without tip guard and trigger guard installed. • Engage trigger lock when not spraying. • Follow Pressure Relief Procedure in this manual, when you stop spraying and before cleaning, checking, or servicing equipment.
	<p>EQUIPMENT MISUSE HAZARD</p> <p>Misuse can cause death or serious injury.</p> <ul style="list-style-type: none"> • Do not exceed the maximum working pressure or temperature rating of the lowest rated system component. See Technical Data in all equipment manuals. Read fluid and solvent manufacturer's warnings. For complete information about your material, request MSDS from distributor or retailer. • Use fluids and solvents that are compatible with equipment wetted parts. See Technical Data in all equipment manuals. Read fluid and solvent manufacturer's warnings. • Check equipment daily. Repair or replace worn or damaged parts immediately with genuine Graco replacement parts only. • Do not alter or modify equipment. • For professional use only. • Use equipment only for its intended purpose. Call your Graco distributor for information. • Route hoses and cables away from traffic areas, sharp edges, moving parts, and hot surfaces. • Do not kink or overbend hoses or use hoses to pull equipment. • Comply with all applicable safety regulations. • Keep children and animals away from work area. • Do not operate the unit when fatigued or under the influence of drugs or alcohol.

 WARNING	
	<p>PRESSURIZED ALUMINUM PARTS HAZARD</p> <p>Do not use 1,1,1-trichloroethane, methylene chloride, other halogenated hydrocarbon solvents or fluids containing such solvents in pressurized aluminum equipment. Such use can cause serious chemical reaction and equipment rupture, and result in death, serious injury, and property damage.</p>
	<p>TOXIC FLUID OR FUMES HAZARD</p> <p>Toxic fluids or fumes can cause serious injury or death if splashed in the eyes or on skin, inhaled, or swallowed.</p> <ul style="list-style-type: none"> • Read MSDS's to know the specific hazards of the fluids you are using. • Store hazardous fluid in approved containers, and dispose of it according to applicable guidelines.
	<p>PERSONAL PROTECTIVE EQUIPMENT</p> <p>You must wear appropriate protective equipment when operating, servicing, or when in the operating area of the equipment to help protect you from serious injury, including eye injury, inhalation of toxic fumes, burns, and hearing loss. This equipment includes but is not limited to:</p> <ul style="list-style-type: none"> • Protective eyewear • Clothing and respirator as recommended by the fluid and solvent manufacturer • Gloves • Hearing protection



Installation

Typical Installation

The typical installation shown in FIG. 1 is only a guide for selecting and installing air-assisted spray systems. Contact your Graco distributor for assistance in designing a system to meet your needs.

						
<p>VENTILATE THE SPRAY BOOTH</p> <p>To prevent hazardous concentrations of toxic and/or flammable vapors, spray only in a properly ventilated spray booth. Do not operate the spray gun unless ventilation fans are operating.</p> <p>Check and follow all of the National, State, and Local codes regarding air exhaust velocity requirements.</p> <p>Check and follow all local safety and fire codes.</p>						

Grounding

						
<p>Check your local electrical code and pump manual for detailed grounding instructions. Use only electrically conductive fluid hoses.</p> <p>Ground the spray gun through connection to a properly grounded fluid supply hose and pump.</p>						

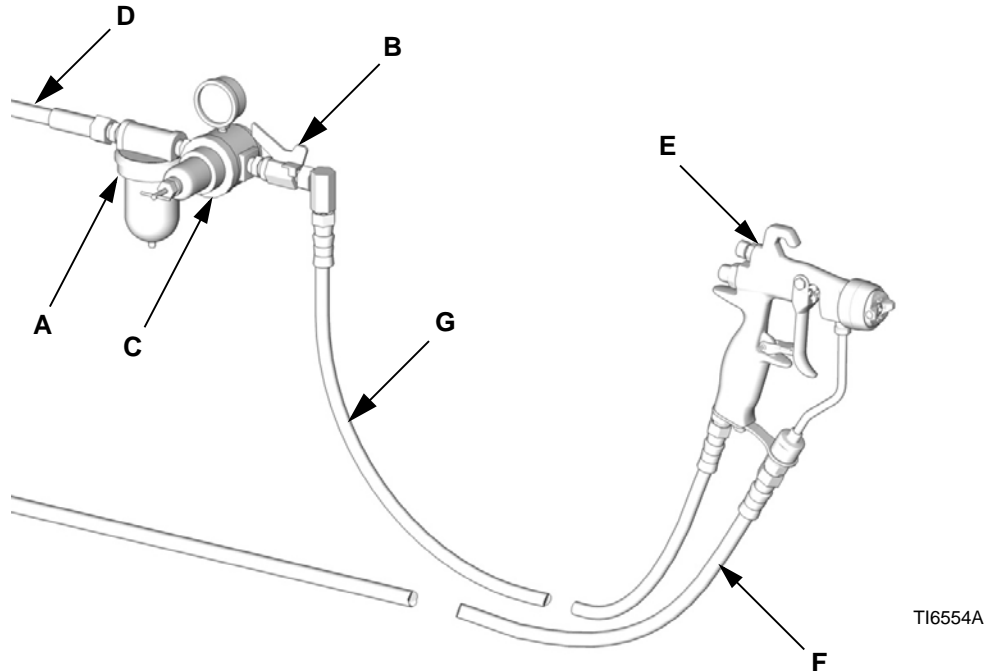



Fig. 1: Typical Installation (Model G15 Shown)

Key:

- | | |
|------------------------------|--------------------------------------|
| A Air Line Filter | E Spray Gun |
| B Air Shutoff Valve | F Electrically Conductive Fluid Hose |
| C Gun Air Pressure Regulator | G Gun Air Supply Hose |
| D Air Line | |

Air Line

1. Install an air filter (A) on the gun air line to ensure a dry, clean air supply to the gun. Dirt and moisture can ruin the appearance of your finished workpiece. See FIG. 1.
2. Install an air pressure regulator (C) on the gun air line to control air pressure to the gun.
3. Install an air shutoff valve (B) on the gun air line and on the pump air line, to shut off air to the gun.
4. Use a 3/16 in. (5 mm) I.D. or larger air hose to minimize excessive pressure drop in the hose.

 The gun air inlet has a 1/4-18 npsm (R1/4-19) compound male thread that is compatible with NPSM and BSP female swivel connectors.

5. Connect the air hose (G) to the 1/4 npsm gun air inlet. See FIG. 2.

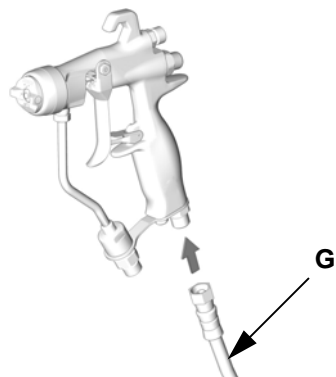

T16556A

FIG. 2

6. Connect the other end of the air hose (G) to the outlet of the air shutoff valve. See FIG. 3.

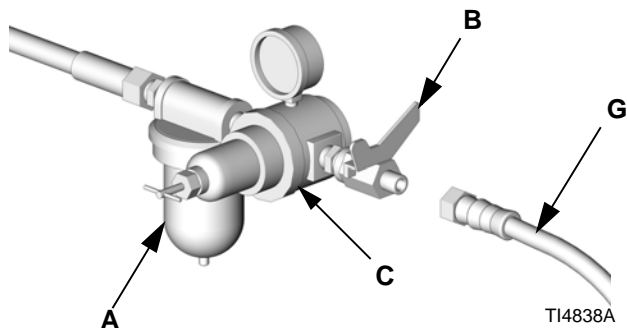

T14838A

FIG. 3

Fluid Line

- Before connecting the fluid line, blow it out with air and flush it with solvent. Use solvent which is compatible with the fluid to be sprayed.
- If better control of fluid pressure is needed, install a fluid regulator on the fluid line to better control fluid pressure to the gun.

1. Use a fluid filter to remove coarse particles and sediment, to avoid clogging the spray tip and causing finishing defects.

 Guns are equipped with a built-in 100 mesh fluid filter to provide final filtering just before spraying.

2. Connect the fluid hose (F) to the gun fluid inlet. See FIG. 4. If desired, install a fluid swivel connector (115898) at the gun inlet for best maneuverability. See Accessories, page 33.

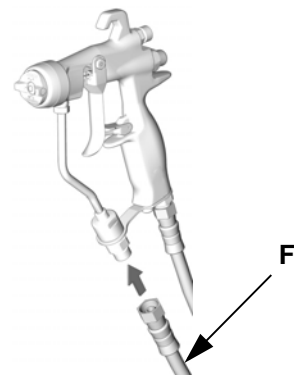

T16846A

FIG. 4

3. Connect the other end of the fluid hose (F) to the pump fluid outlet.

Setup

Flush Before Using Equipment

1. The equipment was tested with lightweight oil, which is left in the fluid passages to protect parts. To avoid contaminating your fluid with oil, flush the equipment with a compatible solvent before using the equipment. See **Flushing and Cleaning**, page 14.
2. Relieve the pressure. See **Pressure Relief Procedure**, page 10.

Select a Spray Tip and Air Cap

The fluid flow and pattern width depend on the size of the spray tip, the fluid viscosity, and the fluid pressure. See **Spray Tip Selection Chart**, page 30. Contact your Graco distributor for assistance in selecting an appropriate spray tip for your application.

Install a Spray Tip

Install a spray tip in the gun. Ensure that the tip locating tab is positioned in the slot of the air cap. See FIG. 5. Tighten the air cap retaining ring (6) firmly by hand to ensure a good seal between the tip gasket and the diffuser (5).

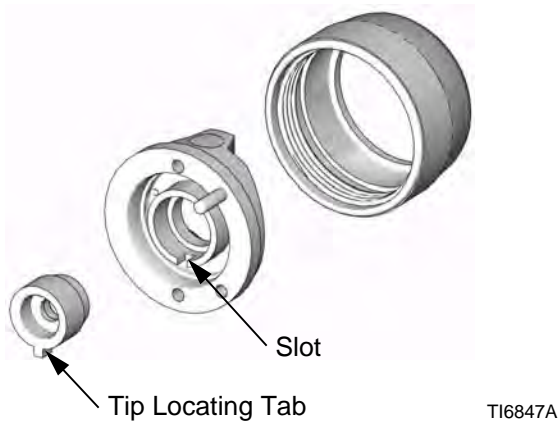

Position the Air Cap

The air cap and spray tip position determines the direction of the spray pattern.

Rotate the air cap (the spray tip rotates with it) as needed to achieve the desired spray pattern direction. See FIG. 6.

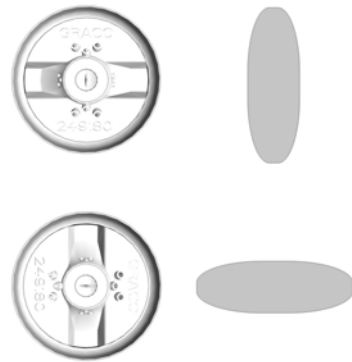

FIG. 6

Air Cap Alignment Pin

Model G15 guns (288844) use an air cap alignment pin to position the air cap. The standard location of the air cap alignment pin is the horizontal air cap position.

If you would like to change the spray pattern direction, use a needle nose pliers to unscrew the pin and relocate it to the desired position. See FIG. 7. When relocating the pin use low-strength thread locker. Torque to 1.5-2.5 in-lb (0.2-0.3 N•m). **DO NOT OVERTIGHTEN.**

The air cap alignment pin can be removed according to preference.

Air cap alignment pins do not come standard with model G40 guns (249242).

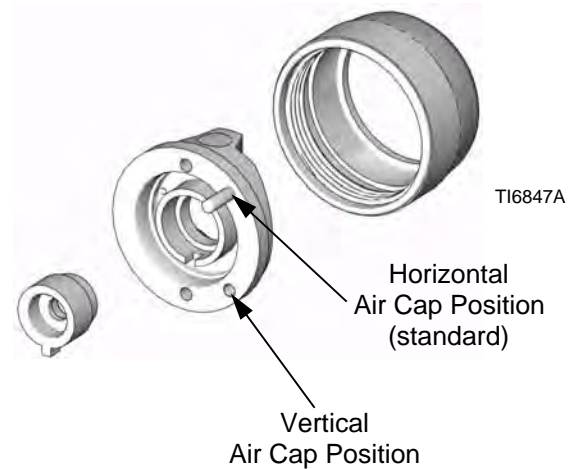

FIG. 7

Reverse-A-Clean® (RAC) Tip

Model 249238 guns use a Reverse-A-Clean® (RAC) tip.

To assemble the RAC tip, insert the seat housing into the air cap assembly.

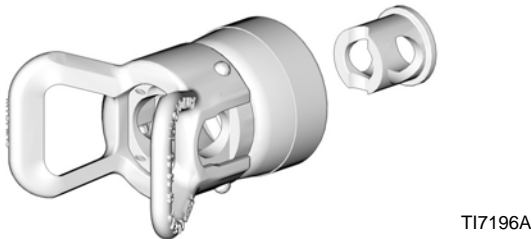

FIG. 8

Insert the gasket seat.

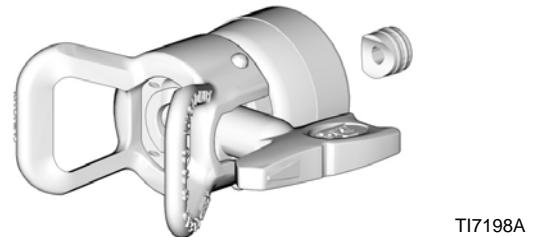

FIG. 10

Insert the SwitchTip.

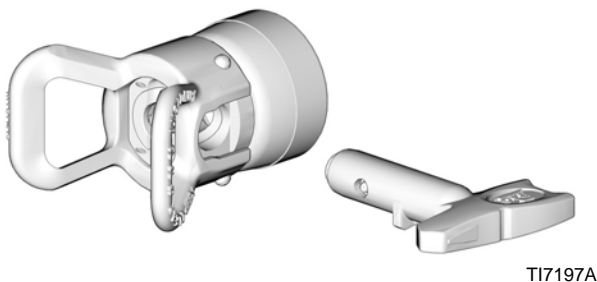

FIG. 9

Screw the RAC tip assembly onto the gun and tighten firmly by hand.

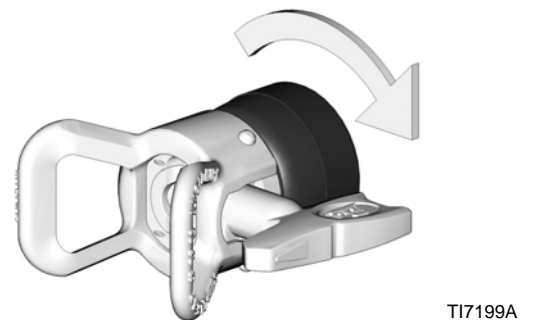





FIG. 11

Operation

Safety

						
<p>SKIN INJECTION HAZARD</p> <p>Remember, this is not an air spray gun. For your safety be sure to read and follow the WARNING on pages 4 and 5 and throughout the text of this instruction manual.</p> <p>Keep the wallet sized warning card (222385), provided with the gun, with the operator of this equipment at all times. The card contains important treatment information should an injection injury occur. Additional cards are available at no charge from Graco.</p>						

Pressure Relief Procedure

						
<p>SKIN INJECTION HAZARD</p> <p>The system pressure must be manually relieved to prevent the system from starting or spraying accidentally. Fluid under high pressure can be injected through the skin and cause serious injury. To reduce the risk of an injury from injection, splashing fluid, or moving parts, follow the Pressure Relief Procedure whenever you:</p> <ul style="list-style-type: none"> • are instructed to relieve the pressure, • stop spraying, • check or service any of the system equipment, • or install or clean the spray tip. <p>Follow Pressure Relief Procedure on page 10 when you stop spraying and before cleaning, checking, servicing, or transporting equipment. Read WARNING, page 4-5</p>						

1. Engage the trigger lock. See FIG. 13.
2. Shut off the pump. See your pump manual.
3. Shut off the gun air supply.
4. Disengage the trigger lock. See FIG. 13.

5. Hold a metal part of the gun firmly to a grounded metal pail. Trigger the gun to relieve pressure. See FIG. 12.

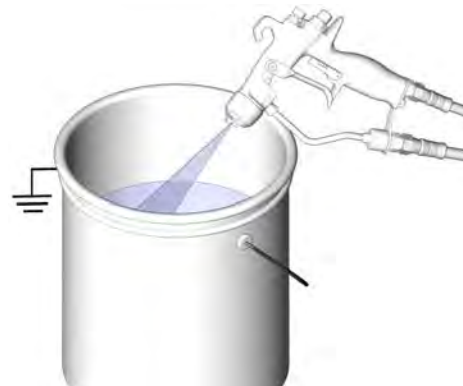

T16555A

FIG. 12

6. Open all fluid drain valves in the system, having a waste container ready to catch drainage. Leave drain valve(s) open until you are ready to spray again.
7. Engage the trigger lock. See FIG. 13.
8. If you suspect the spray tip or hose is clogged or that pressure has not been fully relieved after following the steps above, **VERY SLOWLY** loosen the tip guard retaining ring or hose end coupling to relieve pressure gradually, then loosen completely. Clear hose or tip obstruction.

Trigger Lock

Always engage the trigger lock when you stop spraying to prevent the gun from being triggered accidentally by hand or if dropped or bumped.

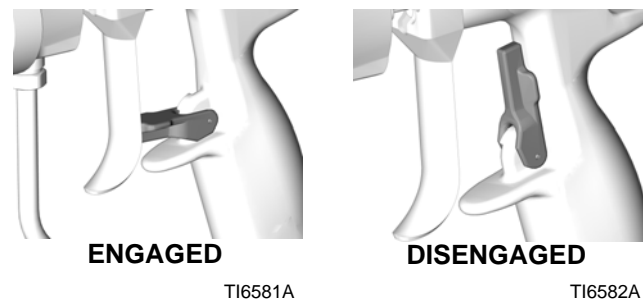

FIG. 13



How the Air-Assisted Spray Gun Operates

The air-assisted spray gun combines airless and air spraying concepts. The spray tip shapes the fluid into a fan pattern, as does a conventional airless spray tip. Air from the air cap further atomizes the fluid and completes the atomization of the paint tails into the pattern to produce a more uniform pattern. The width of the pattern can be adjusted by the pattern adjustment valve.

The air-assisted spray gun differs from an air spray gun in that increasing the pattern air reduces the pattern width. To increase the pattern width, use less pattern air or a larger size tip.

The spray gun has a built-in lead and lag operation. When triggered, the gun begins emitting air before the fluid is discharged. When the trigger is released, the fluid stops before the air flow stops. This helps assure the spray is atomized and prevents fluid buildup on the air cap.

Spray Pattern Adjustment

						
SKIN INJECTION HAZARD						
To reduce the risk of component rupture and serious injury, including injection, do not exceed the gun's maximum fluid working pressure or the maximum working pressure of the lowest rated component in the system.						

- Do not turn on the gun air supply yet. Set the fluid pressure at a low starting pressure. If a fluid pressure regulator is installed, use it to make adjustments.

If your system does not have a fluid regulator, the fluid pressure is controlled by the air regulator supplying the pump, per the formula below:

$$\text{Pump Ratio} \times \text{Pump Air Regulator Setting} = \text{Fluid Pressure}$$

- Trigger the gun to check the atomization; do not be concerned about the pattern shape yet.

- Slowly increase the fluid pressure, just to the point where a further increase in fluid pressure does not significantly improve fluid atomization.
- Close off the pattern adjustment air by turning the knob clockwise (in) all the way. See FIG. 14. This sets the gun for its widest pattern.

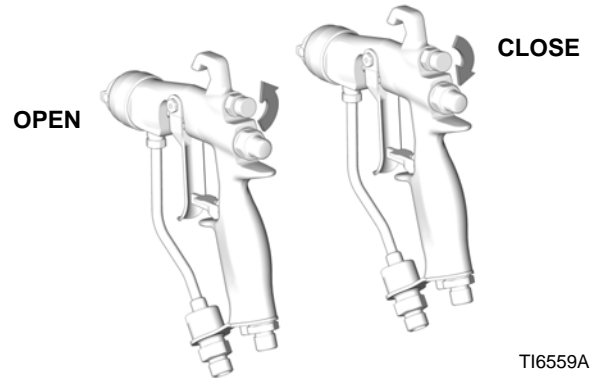

FIG. 14

- Set the atomizing air pressure at about 5 psi (3.5 kPa, 0.35 bar) when triggered. Check the spray pattern, then slowly increase the air pressure until the tails are completely atomized and pulled into the spray pattern. See FIG. 15. Seven to 10 psi (4.9 to 7.0 kPa, 0.49 to 0.7 bar) air pressure is typically enough to atomize the tails, especially for low viscosity materials. Setting the air pressure too high will cause material to build up on the air cap and decrease transfer efficiency. Do not exceed 100 psi (0.7 MPa, 7 bar) air pressure to the gun.

For a narrower pattern, turn the pattern adjustment valve knob counterclockwise (out). See FIG. 14. If the pattern is still not narrow enough, increase the air pressure to the gun slightly or use a different size tip. (Not available for RAC tip guns.)

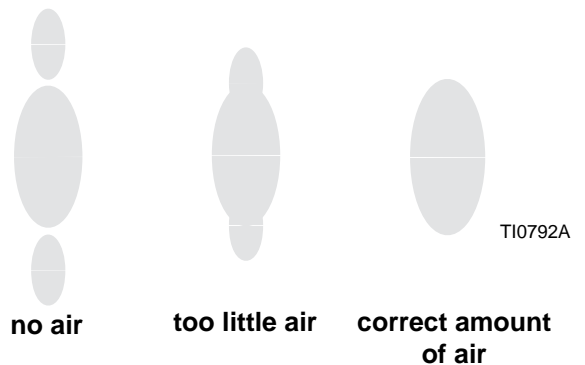



FIG. 15

HVLP Operation

 For HVLP operation, the atomization air must not exceed 10 psi. Use HVLP Verification Kit 249140 to verify air psi.

 There is no fan adjustment when using RAC tips and caps.

1. To achieve the best results when applying fluid, keep the gun perpendicular to the surface and maintain a consistent distance of approximately 8 to 12 in. (200 to 300 mm) from the object being sprayed.
2. To obtain an even finish, use smooth, even strokes across the object being sprayed with 50% overlap.
3. Paint using parallel strokes. This spray gun applies all coatings evenly without cross coating.

Fluid Application

Always hold the gun at a right angle from the surface. Do not make an arc with the gun as it causes an uneven coat of fluid. See FIG. 16.

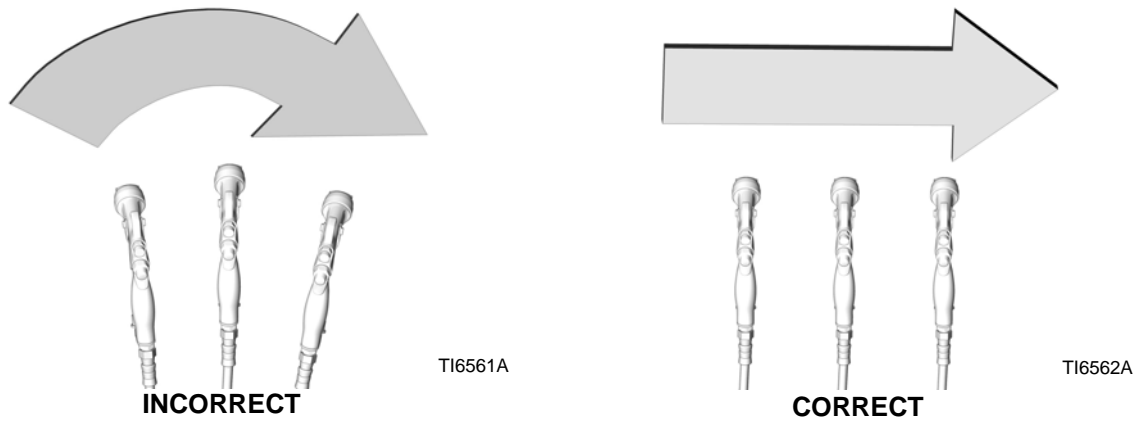







FIG. 16

Daily Gun Care, Flushing, and Cleaning

							
SKIN INJECTION HAZARD Follow the Pressure Relief Procedure on page 10 before cleaning the gun.							

CAUTION
Methylene chloride with formic or propionic acid is not recommended as a flushing or cleaning solvent with this gun as it will damage aluminum and nylon components.

CAUTION	
Solvent left in gun air passages could result in a poor quality paint finish. Do not use any cleaning method which may allow solvent into the gun air passages.	
Do not point the gun up while cleaning it.	Do not wipe the gun with a cloth soaked in solvent; wring out the excess.
 TI6563A	 TI4827A
Do not immerse the gun in solvent.	Do not use metal tools to clean the air cap holes as this may scratch them; scratches can distort the spray pattern.
 TI6564A	 TI6565A

General System Maintenance

1. Relieve the pressure, page 10.
2. Clean the fluid and air line filters daily.
3. Check for any fluid leakage from the gun and fluid hoses. Tighten fittings or replace equipment as needed.
4. Flush the gun before changing colors and whenever you are done operating the gun.

Fluid Filter Maintenance

1. Unscrew the fluid inlet fitting (18).
2. Remove and inspect the inline fluid filter (12). Clean or replace the filter as necessary.

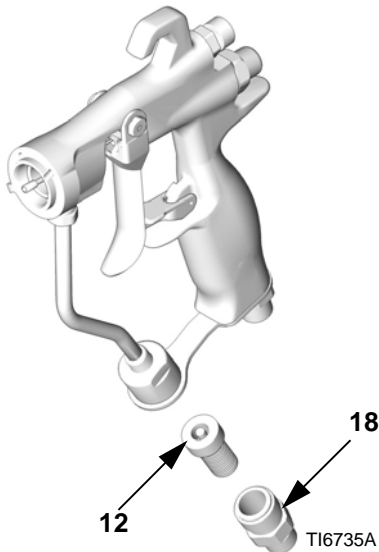

FIG. 17

Flushing and Cleaning

FIRE AND EXPLOSION HAZARD Read WARNING , page 4. Follow Grounding instructions, page 6.						

- Flush before changing colors, before fluid can dry in the equipment, at the end of the day, before storing, and before repairing equipment.
- Flush at the lowest pressure possible. Check connectors for leaks and tighten as necessary.
- Flush with a fluid that is compatible with the fluid being dispensed and the equipment wetted parts.

1. Relieve the pressure, page 10.
2. Remove the air cap retaining ring (6), air cap (21), and spray tip (33).
3. Disconnect the fluid supply hose (F) and air supply hose (G) from the gun.

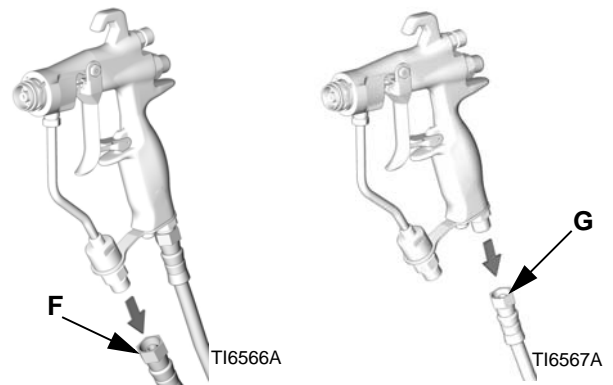

FIG. 18

- Connect the solvent supply hose (T) to the gun.

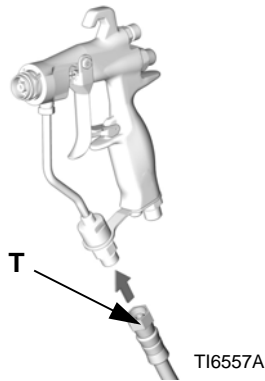

FIG. 19

- Increase the pressure slowly. Point the gun down into a grounded metal container, and flush the gun with solvent until all traces of fluid are removed from the gun passages.



FIG. 20

- Turn off the solvent supply.
- Relieve the pressure.
- Disconnect the solvent supply hose (T) from the gun.

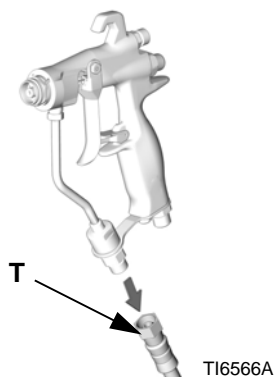

FIG. 21

CAUTION

Trigger the gun whenever you tighten or remove the diffuser (5). This keeps the needle ball away from the seating surface and prevents the seat from being damaged.

- If it is necessary to remove the diffuser (5) to clean, trigger the gun while you remove the diffuser with the gun tool (30).
- Dip the end of a soft-bristle brush into a compatible solvent. Do not continuously soak the brush's bristles with solvent and do not use a wire brush.



FIG. 22

- With the gun pointed down, clean the front of the gun, using the soft-bristle brush and solvent.



FIG. 23

- Scrub the air cap retaining ring (6), air cap (21), diffuser (5), and spray tip (33) with the soft-bristle brush. To clean out air cap holes, use a soft tool, such as a toothpick, to avoid damaging critical surfaces. Blow air through the spray tip to ensure the orifice is clean. Clean the air cap and spray tip daily, minimum. Some applications require more frequent cleaning.

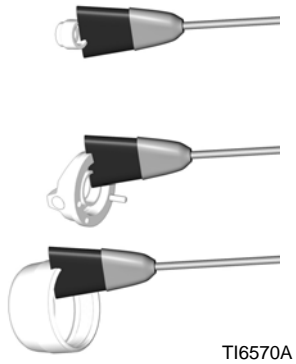

FIG. 24

13. If the diffuser was removed, trigger the gun while you reinstall the diffuser (5) with the gun tool (30). Tighten the diffuser securely to obtain a good seal. Torque to 155-165 in-lb (18-19 N•m). When properly tightened, the flange will bottom out on the gun.

14. Install the air cap retaining ring (6), air cap (21), and spray tip (33).

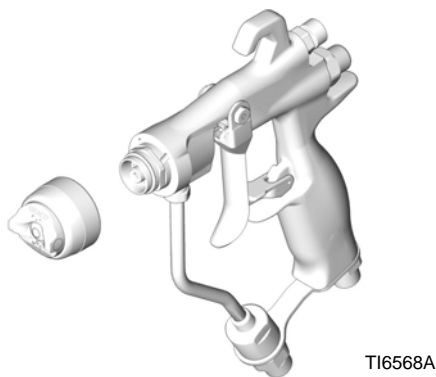

FIG. 25

15. Dampen a soft cloth with solvent and wring-out the excess. Point the gun down and wipe off the outside of the gun.

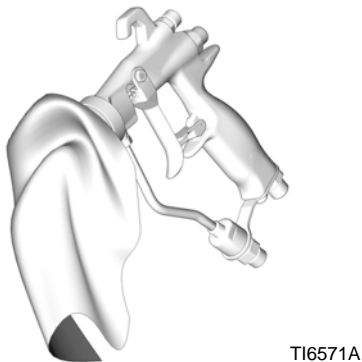

FIG. 26

16. After cleaning the gun, lubricate the following parts with lubricant 111265 weekly:

- Trigger pivot pin (A)
- Boss on both sides of the gun where the trigger contacts the gun body (B)
- Fluid needle shaft, behind trigger (C)

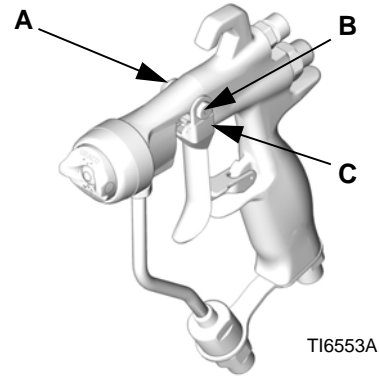



FIG. 27

Reverse-A-Clean[®] (RAC) Tip

 Do not soak the RAC tip seat gasket (33a) in solvent for extended periods of time or swelling may occur.

Clearing a clogged RAC tip

Release the trigger and engage the trigger lock.



FIG. 28

Rotate the SwitchTip.

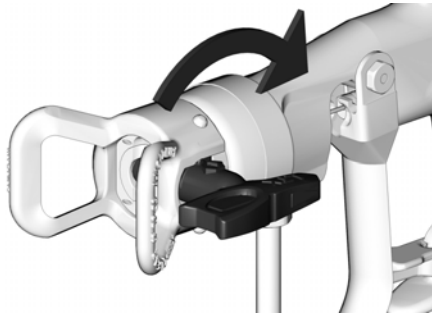

TI7200A

FIG. 29

Engage the trigger lock.

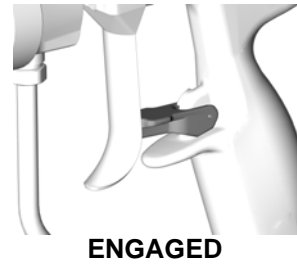

ENGAGED

TI6581A

FIG. 32

Disengage the trigger lock.



DISENGAGED

TI6582A

FIG. 30

Return the SwitchTip to its original position.

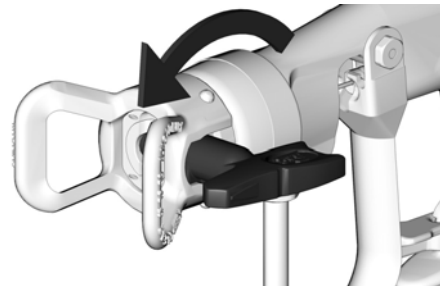

TI7201A

FIG. 33

Trigger the gun into a pail to clear the clog.

SKIN INJECTION HAZARD Do not point gun at anyone or at any part of the body.							



TI7202A

FIG. 31

Disengage the trigger lock and continue spraying.

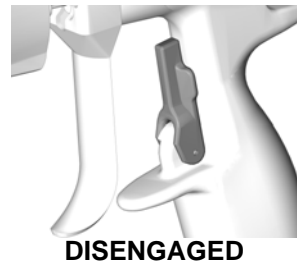



DISENGAGED

TI6582A

FIG. 34



Troubleshooting

						
<p>SKIN INJECTION HAZARD Follow Pressure Relief Procedure on page 10. Read warnings, page 4.</p>						

-  • Check all possible remedies in the troubleshooting charts before disassembling the gun.
- Some improper patterns are caused by the improper balance between air and fluid.

General Troubleshooting

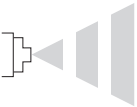
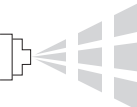
Problem	Cause	Solution
Fluid leakage from back of fluid packing area.	Worn packings or needle shaft.	Replace needle assembly (2).
Air leakage from gun.	Air valve not seating properly.	Clean or replace air valve (8).
Fluid leakage from front of gun.	Needle ball worn or damaged.	Replace needle assembly (2) and seat (5c).
	Worn seat assembly.	Replace the seat (5c) and gasket (5b, carbide models only). The gasket must be replaced whenever the seat assembly is removed. Do not reverse the direction of the plastic seat (5c, model 288844 gun only) if it is worn. The seat must be replaced if it is worn.
	Fluid viscosity too low for proper seal with carbide seat.	Install plastic seat (5c).
Fluid in air passages.	Spray tip seal leaking.	Tighten retaining ring (6) or replace spray tip (33).
	Leaking around seat housing.	Replace the gasket (5b, carbide models only). The gasket must be replaced whenever the seat assembly is removed.
	Fluid inlet fitting leaking.	Replace the fluid tube gasket (22). The gasket must be replaced whenever the fluid tube connector is removed.
Slow fluid shut-off.	Fluid buildup on fluid needle components.	Remove and clean or replace the fluid needle assembly (2).
No fluid output when triggered.	Spray tip plugged.	Clean spray tip. See page 14.
	Fluid filter or fluid hose plugged.	After tip removal (see above), very slowly loosen the hose end coupling at the gun and relieve pressure gradually. Then loosen completely to clear the obstruction. Clean or replace filter (12).

Problem	Cause	Solution
Fluttering or spitting spray. 	Insufficient fluid supply.	Adjust fluid regulator or fill fluid supply tank.
	Air in paint supply line.	Check, tighten pump siphon hose connections, bleed air from paint line.
	Attempting to “feather” (partially trigger the gun).	Cannot “feather” with an AA gun. Feather will cause drastic reduction of pressure at the tip, resulting in poor atomization and/or spitting.
Striping spray. 	Spray tip partially plugged.	Clean or replace spray tip. See page 14.
Irregular pattern. 	Fluid build-up on spray tip, or spray tip partially plugged.	Clean or replace spray tip. See page 14.
	On defective side of pattern, air horn holes are partially or totally plugged.	Clean air horn holes with solvent and soft brush. See page 14.
Pattern pushed to one side, same side of air cap gets dirty.	Air horn holes partially or totally plugged.	Clean air horn holes with solvent and soft brush or toothpick. See page 14.
Material build up on air cap.	Air pressure setting too high.	Reduce inlet air pressure. Seven to 10 psi (4.9 to 7.0 kPa, 0.49 to 0.7 bar) air pressure when triggered is recommended.

Repair

Items Needed for Service

- Seal Installation Tool (28)-- provided
- Nut Driver Tool (29) -- provided
- Gun Tool (30) -- provided
- O-ring Pick
- 7/32 in. Hex Wrench
- 3/16 in. Hex Wrench
- Compatible Solvent
- Lubricant (part number 111265)

Repair Kits

- Seal Repair Kit 249422 is available. For best results, use all the new parts in the kit. Kit parts are marked with an asterisk, for example (7*).
- Plastic Seat Repair Kit 249424 and Carbide Seat Repair Kit 249456 are available and can be used with both Model G15 guns and Model G40 guns. For best results, use all new parts in the kit. Kit parts are marked with a symbol in the Parts list, for example (5c†).
- Plastic Seat Kit 249424 is intended for low pressure usage.

Fan Valve Replacement

1. Relieve the pressure, page 10.
2. Unscrew the fan valve packing nut (A) from the back of the gun body (1). Slide the fan valve assembly (4) out of the gun body. See FIG. 35.
3. Before reinstalling, turn the pattern adjustment valve (C) of the replacement fan valve assembly (4) completely counterclockwise to prevent damage to the seat (5c). Install the replacement fan valve assembly into the gun body (1). Screw the packing nut (A) into the gun body and torque to 90 in-lb (10.5 N•m).

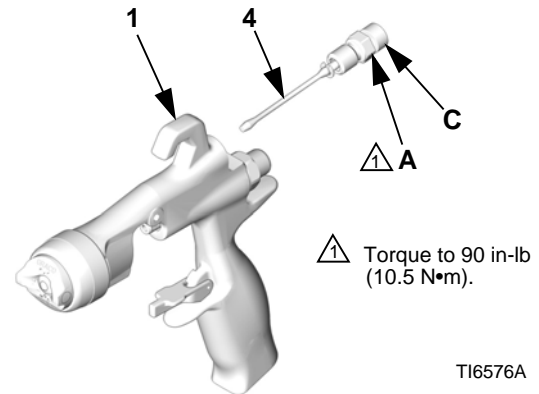

FIG. 35

Complete Gun Packing Repair

Disassembly

Seat Repair

- See Repair Kits, page 20.
- Clean parts with a solvent that is compatible with the parts and the fluid being sprayed.

1. Relieve the pressure, page 10. Remove the fluid and air hoses from the gun.
2. Remove the air cap retaining ring (6), air cap (21), and spray tip (33). See FIG. 36.

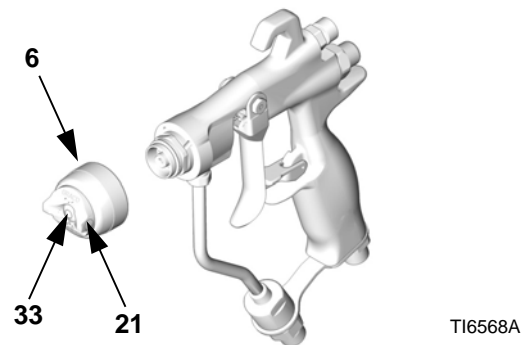

FIG. 36

3. Trigger the gun to pull the needle housing off the seat while you unscrew the diffuser (5) from the gun body (1), using the gun tool (30).

4. Inspect the o-rings (5e*, 5f*, and 5g*) in place. Carefully remove the o-rings from the diffuser housing (5a) and replace if necessary.
5. Remove the seat nut (5d), seat (5c) and seat gasket (5b, carbide models only) using a 7/32 in. hex wrench.
6. Inspect the seat (5c) and seat gasket (5b) and replace if necessary.
7. Reinstall the seat gasket (5b, carbide models only), seat (5c), and seat nut (5d). Torque to 45-50 in-lb. Be sure not to overtighten the nut.

- When reinstalling the carbide seat (5c), the tapered end of the seat (red side) must point toward the gun tip.
- The plastic seat (5c, model 288844 guns), can be reinstalled in either direction. Do not reverse the direction of the plastic seat if it is worn. The seat must be replaced if it is worn.

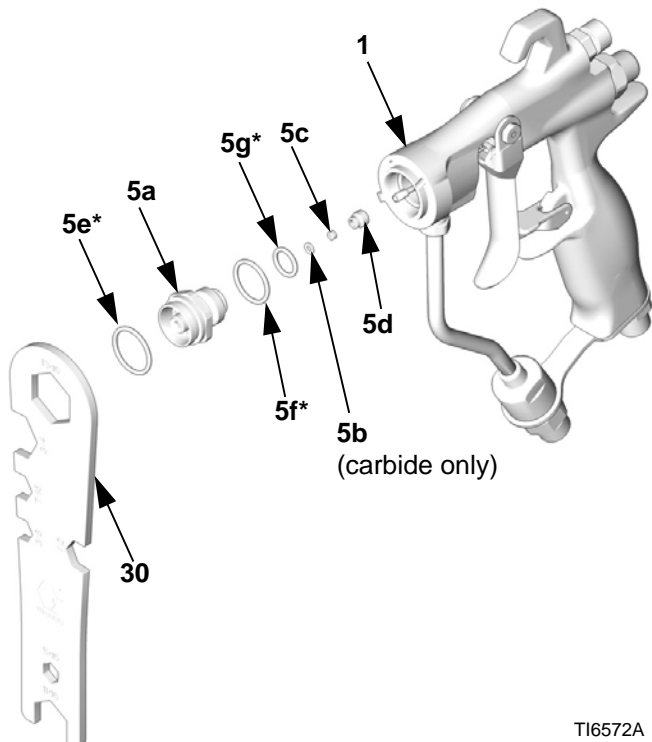

FIG. 37

Needle Repair

1. Remove the diffuser, see Seat Repair, page 20.
2. Remove the trigger pivot pin nut (14‡), pivot pin (13‡), and trigger (3‡) using the gun tool (30) and nut driver (29). See FIG. 38.

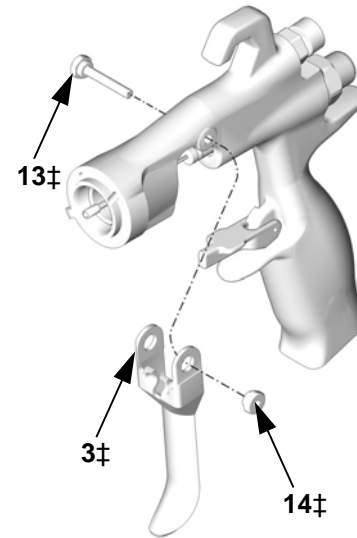

FIG. 38

3. Remove the fluid needle assembly (2) from the front of the gun by using the nut driver tool (29). If the needle is bent or damaged, or the packing is worn or leaking, replace the entire needle assembly. If replacement is necessary, be sure to remove the o-ring (2a*) as it may stick inside the gun body. See FIG. 39.

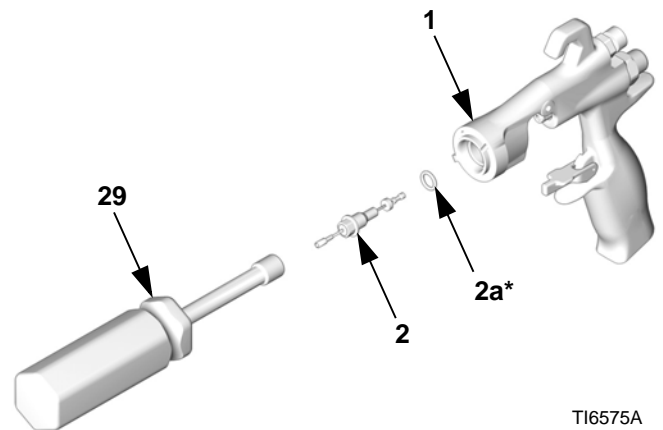
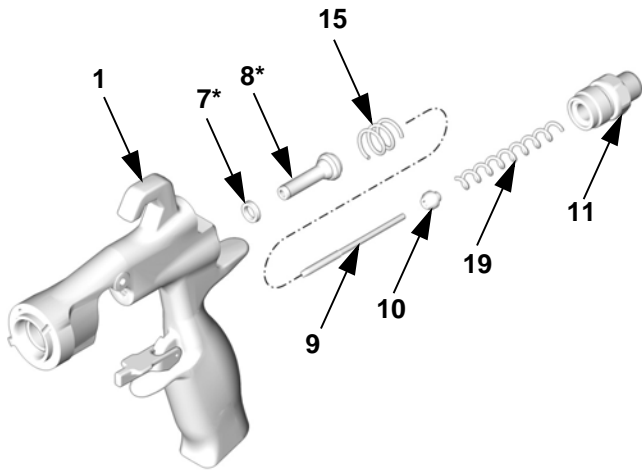

FIG. 39

Air Valve Repair

1. Unscrew the spring cap (11) from the back of the gun body (1) using the gun tool (30). Remove the two springs (15 and 19), the shaft (9), and seat (10).
2. Push the air valve assembly (8*) out the back of the gun. See FIG. 40.
3. Inspect the u-cup (7*) in the gun body (1). If the u-cup is worn or leaking, carefully remove the u-cup from the front of the gun body, using a pick.



TI6577A

FIG. 40

Fluid Tube Replacement

1. Remove the air inlet fitting (17) using the gun tool (30) and remove the screw (20) using a 3/16 in. hex wrench.
2. Unscrew the fluid inlet fitting (18). Remove and clean or replace the inline fluid filter (12).
3. Unscrew the fluid tube connector (C) from the gun's fluid inlet. Carefully remove the gasket (22*).

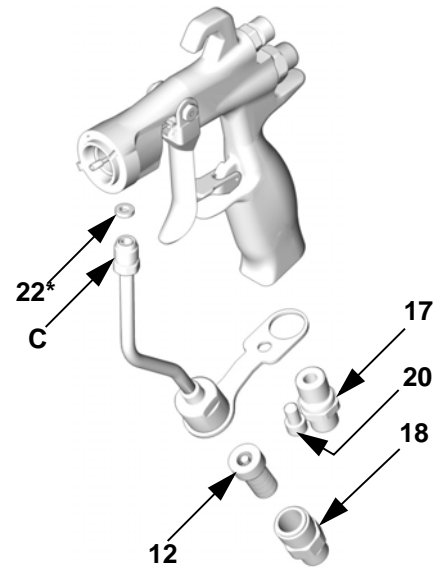

TI6573A

FIG. 41



A series of 24 horizontal lines spanning the width of the page, providing a template for writing. The lines are evenly spaced and extend from the left margin to the right margin.

Reassembly

- See Repair Kits, page 20.

1. Install the tube gasket (22*) in the gun. Handtighten the fluid tube connector (C) into the gun's fluid inlet. Handtighten the air inlet fitting (17) and screw (20). Torque the fluid tube connector to 150-160 in-lb (17-18 N•m). Torque the air inlet fitting to 175-185 in-lb (20-21 N•m). Torque the fluid tube bracket screw to 50-60 in-lb (6-7 N•m). See FIG. 44.
2. Install the inline fluid filter (12) into the base of the fluid tube. Screw the fluid inlet fitting (18) into the base of the tube. Torque to 175-185 in-lb (20-21 N•m). See FIG. 44.
3. Place the new u-cup (7*) on the seal installation tool (28*), with the u-cup lips facing the tool as shown in FIG. 42. Push the u-cup into the back of the gun until you feel a definite snap.

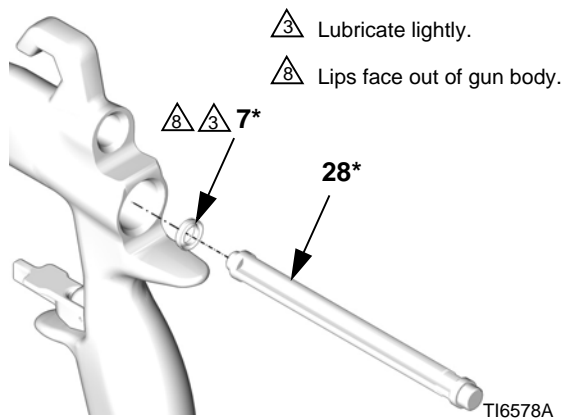

FIG. 42

4. Lubricate the front end of the air valve assembly (8*). Gently slide the air valve assembly into the back of the gun, passing through the u-cup (7*), as far as it will go. Be careful not to damage the u-cup. See FIG. 44.
5. Slide the seat (10) onto the shaft (9). Be sure that the tapered end of the seat is toward the thicker end of the shaft. Carefully insert the shaft (9) and seat (10) in the air valve (8*).

6. Install the two springs (15 and 19). Screw the spring cap (11) into the back of the gun body. Torque to 175-185 in-lb (20-21 N•m).
7. Lightly lubricate the needle assembly o-rings and shaft where the packing slides. Be sure that the o-ring (2a*) is in place in the gun body (1).
8. Insert the fluid needle assembly (2) into the front of the gun. Use the nut driver (29) to screw the fluid needle assembly into the gun body (1) and torque to 50-60 in-lb (6-7 N•m). See FIG. 43.

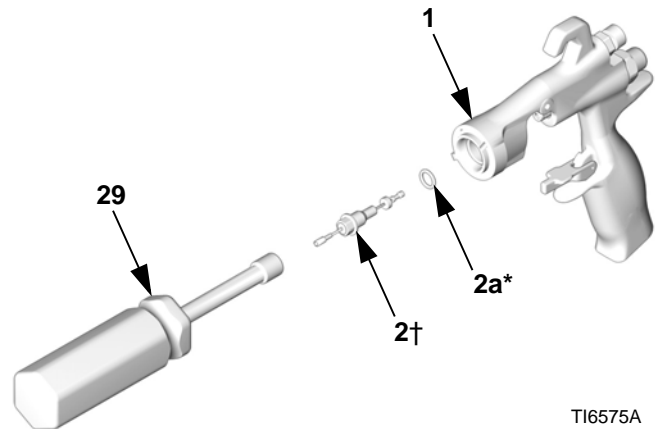

FIG. 43

9. Install the trigger (3), pivot pin (13), and nut (14). Use low strength thread locker and be sure that the brass piece of the fluid needle assembly (2) is behind the trigger. See FIG. 44. Lubricate both sides of the pivot pin where the trigger contacts the pin and lubricate the boss on both sides of the gun where the trigger contacts the gun body. Torque the nut to 20-30 in-lb (2-3 N•m).
10. Trigger the gun to pull the needle back while you screw the diffuser assembly (5) into the gun body (1) using the gun tool (30). Torque to 155-165 in-lb (18-19 N•m). When properly tightened, the flange will bottom out on the gun.
11. Attach the retaining ring (6), air cap (21), and spray tip (33)✘.

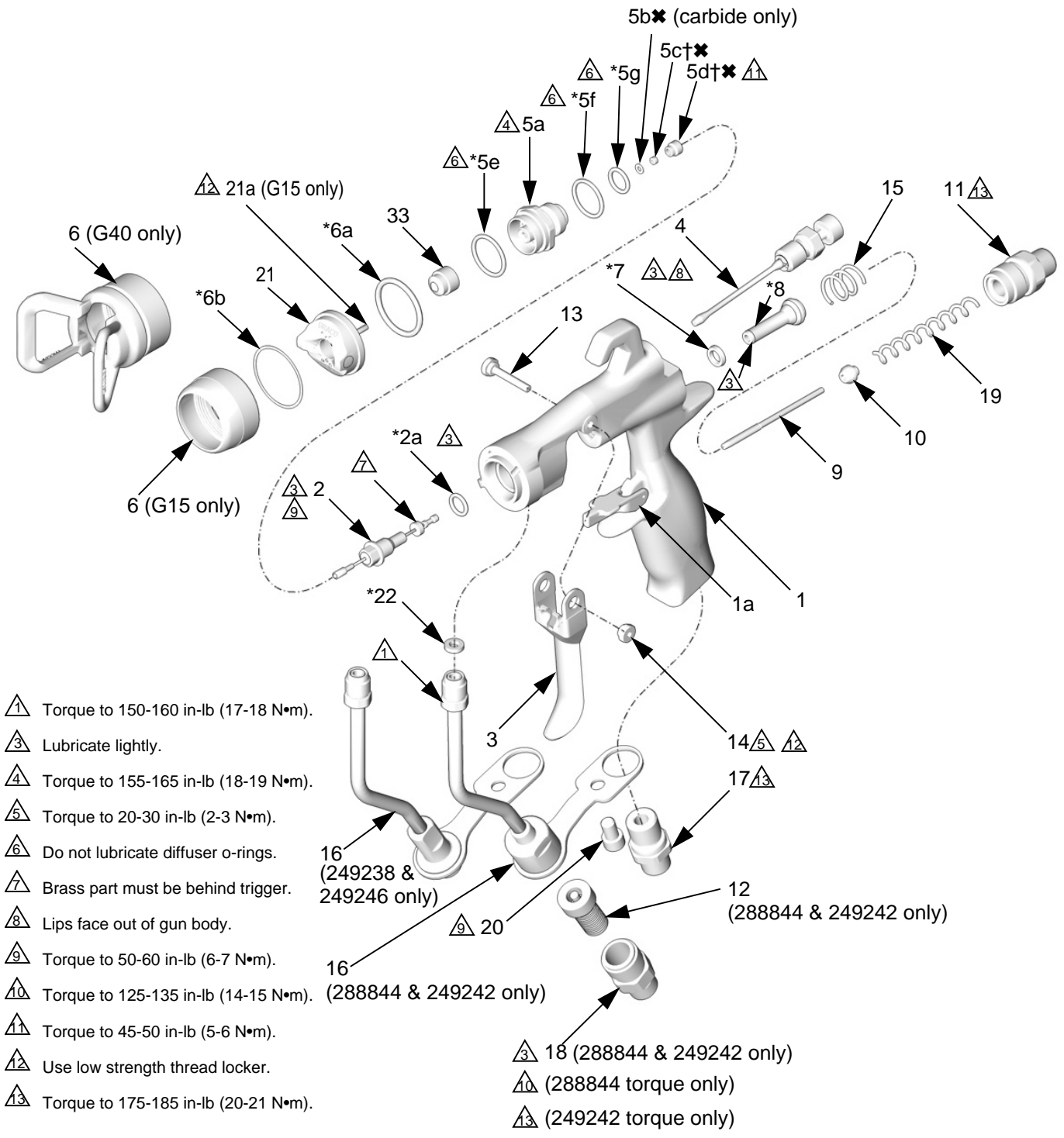

FIG. 44

TI6579B

Parts

Part No. 288844/G15 Gun

Part No. 249242/G40 Gun

Part No. 249246/G40 Gun, High Flow

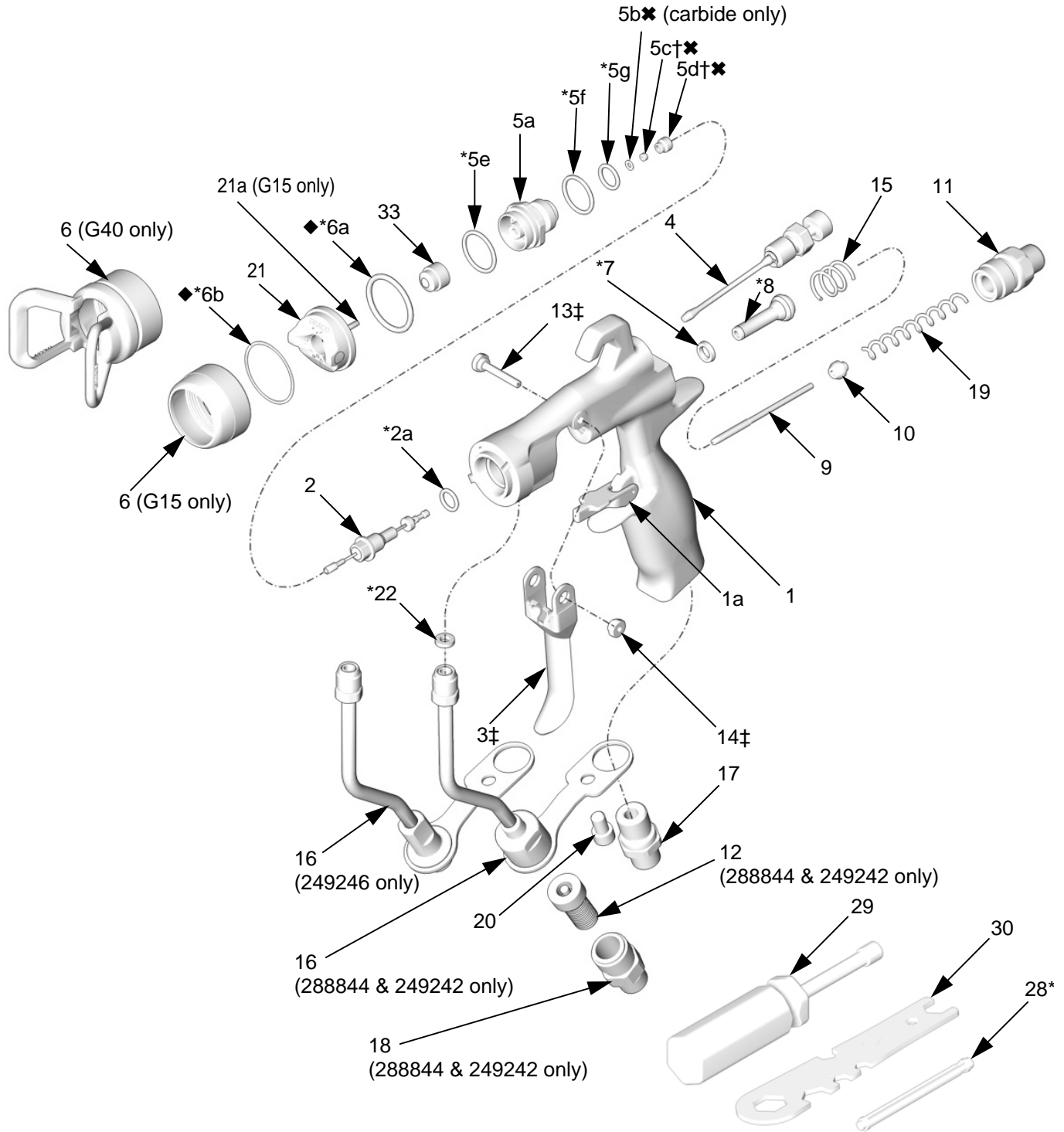

T16579B

Part No. 288844/G15 Gun w/Plastic Seat
Part No. 287926/G15 Gun w/Carbide Seat

Ref.	No.	Part No.	Description	Qty
	1		BODY, gun	1
	1a	249423	STOP, trigger	1
	2	288558	NEEDLE, assy; 3/32 ball; sst	1
			includes item 2a (288844 only)	
		288559	NEEDLE, assy; 3/32 ball; carbide	1
			includes item 2a (287926 only)	
	2a*	110004	PACKING, o-ring; PTFE	1
	3‡		TRIGGER, gun	1
	4	249135	VALVE, fan, assy	1
	5	249132	DIFFUSER, assy (288844 only)	1
		249133	DIFFUSER, assy (287926 only)	1
	5a		DIFFUSER, housing	1
	5b*	288619	GASKET, seat; nylon (287926 only)	1
	5c†		SEAT; plastic (288844 only)	1
	5c*		SEAT; carbide (287926 only)	1
	5d†*		NUT, seat	1
	5e*	111116	PACKING, o-ring, seat; PTFE	1
	5f*	109450	PACKING, o-ring; PTFE	1
	5g*	111457	PACKING, o-ring; PTFE	1
	6	15F192	RING, retaining	1
	6a*◆	109213	PACKING, o-ring; PTFE	1
	6b*◆	15G320	WASHER; PTFE	1
	7*	188493	PACKING, u-cup; UHMWPE	1
	8*		VALVE, air, assy	1
	9	15F193	SHAFT, fluid spring	1
	10	15F194	SEAT, spring	1
	11	15F195	CAP, spring	1
	12	224453	FILTER, tip (pkg of 5)	1
	13‡	15F739	PIN, pivot	1
	14‡	15F740	PIN, pivot, nut	1
	15	114069	SPRING, compression	1
	16	249136	TUBE, assy	1
	17	15F202	FITTING, air inlet	1
	18	15F186	FITTING, hose	1
	19	119767	SPRING, compression (288844 only)	1
		115141	SPRING, compression (287926 only)	1
	20	119996	SCREW, cap, socket hd; 1/4-20 x 3/8 in. (10 mm)	1
	21	249596	AIR CAP, includes item 21a	1
	21a	15G618	PIN, air cap; indexing	1
	22*✓	115133	GASKET, tube, acetal	1
	28*		TOOL, installation; seal	1
	29	117642	TOOL, nut driver	1
	30	15F446	TOOL, gun	1
	31▲	222385	CARD, warning (not shown)	1
	32▲	172479	TAG, warning (not shown)	1
	33		SPRAY TIP, customer's choice	1
	33a	183616	GASKET, tip (not shown)	1

▲ Replacement Danger and Warning labels, tags, and cards are available at no cost.

* Included in Seal Repair Kit 249422 (purchase separately).

† Included in Plastic Seat Repair Kit 249424 (purchase separately).

* Included in Carbide Seat Repair Kit 249456 (purchase separately).

‡ Included in Trigger Repair Kit 249585 (purchase separately).

◆ Included in Air Cap Seal Kit 253032 (purchase separately).

✓ Not for sale separately.

Part No. 249242/G40 Gun w/Standard Tip
Part No. 249246/G40 Gun, High Flow

Ref.	No.	Part No.	Description	Qty
	1		BODY, gun	1
	1a	249423	STOP, trigger	1
	2	288559	NEEDLE, assy; 3/32 ball; carbide	1
			includes item 2a	
	2a*✓	110004	PACKING, o-ring; PTFE	1
	3‡		TRIGGER, gun	1
	4	249135	VALVE, fan, assy	1
	5	249133	DIFFUSER, assy	1
	5a		DIFFUSER, housing	1
	5b*	288619	GASKET, seat; nylon	1
	5c*		SEAT; carbide	1
	5d*		NUT, seat	1
	5e*	111116	PACKING, o-ring, seat; PTFE	1
	5f*✓	109450	PACKING, o-ring; PTFE	1
	5g*✓	111457	PACKING, o-ring; PTFE	1
	6	249256	TIP GUARD	1
			(249242 & 249246 only)	
	6a*◆	109213	PACKING, o-ring; PTFE	1
	6b*◆	15G320	WASHER; PTFE	1
	7*✓	188493	PACKING, u-cup; UHMWPE	1
	8*		VALVE, air, assy	1
	9	15F193	SHAFT, fluid spring	1
	10	15F194	SEAT, spring	1
	11	15F195	CAP, spring	1
	12	224453	FILTER, tip (pkg of 5) (249242 only)	1
	13‡	15F739	PIN, pivot	1
	14‡	15F740	PIN, pivot, nut	1
	15	114069	SPRING, compression	1
	16	249136	TUBE, assy (249242 only)	1
		249317	TUBE, assy (249246 only)	1
	17	15F202	FITTING, air inlet	1
	18	15F186	FITTING, hose (249242 only)	1
	19	115141	SPRING, compression	1
	20	119996	SCREW, cap, socket hd; 1/4-20 x 3/8 in. (10 mm) (249242 only)	1
	21	249180	AIR CAP	1
	22*✓	115133	GASKET, tube, acetal	1
	28*		TOOL, installation; seal	1
	29	117642	TOOL, nut driver	1
	30	15F446	TOOL, gun	1
	31▲	222385	CARD, warning (not shown)	1
	32▲	172479	TAG, warning (not shown)	1
	33		SPRAY TIP, customer's choice	1
	33a	183616	GASKET, tip (not shown)	1

▲ Replacement Danger and Warning labels, tags, and cards are available at no cost.

* Included in Seal Repair Kit 249422 (purchase separately).

* Included in Carbide Seat Repair Kit 249456 (purchase separately).

‡ Included in Trigger Repair Kit 249585 (purchase separately).

◆ Included in Air Cap Seal Kit 253032 (purchase separately).

✓ Not for sale separately.

Parts

Part No. 249238/G40 Gun w/RAC Tip

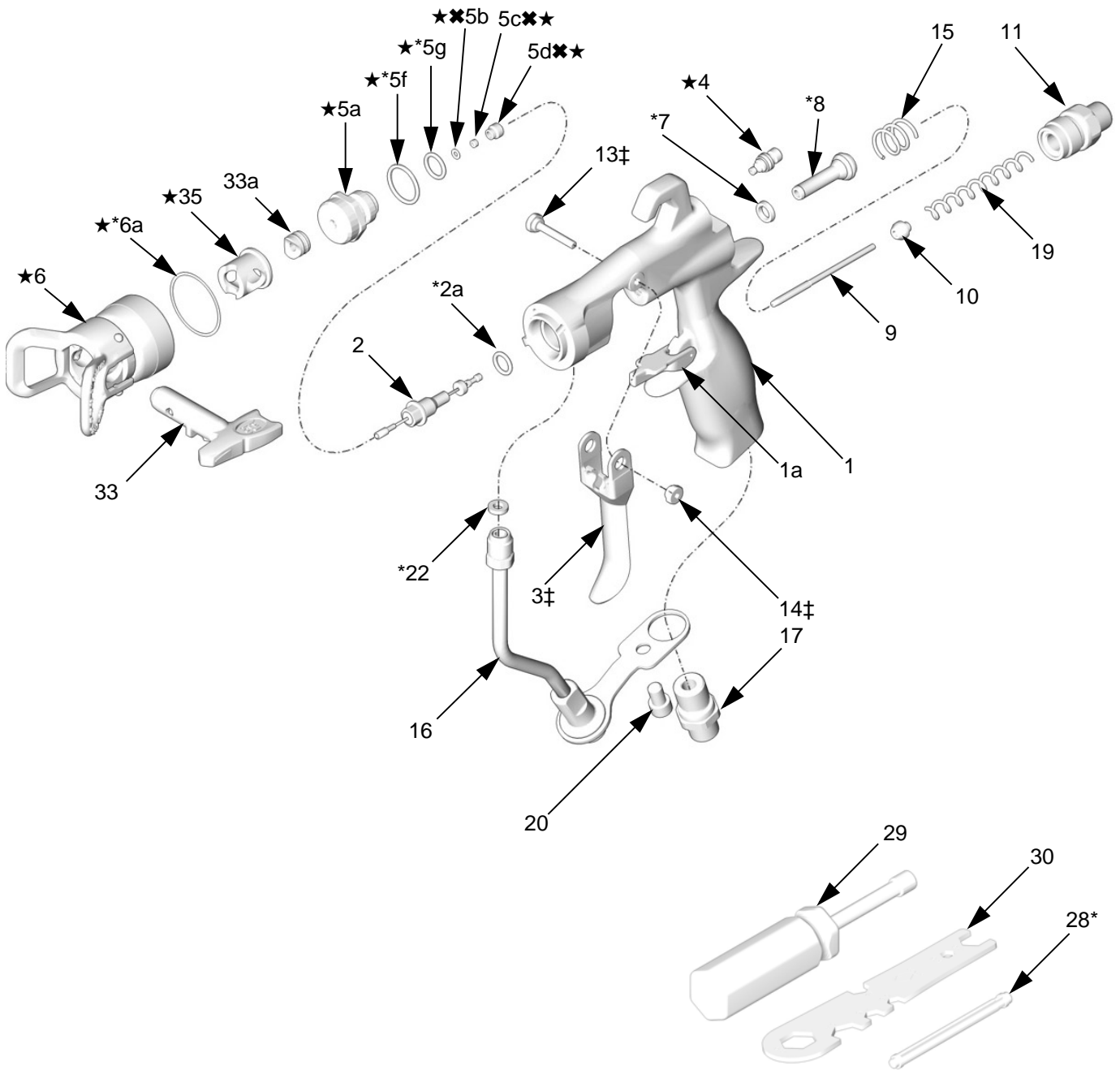

T17203B

Part No. 249238/G40 Gun w/RAC Tip

Ref.			Qty
No.	Part No.	Description	.
1		BODY, gun	1
1a	249423	STOP, trigger	1
2	288559	NEEDLE, assy; 3/32 ball; carbide	1
		includes item 2a	
2a*✓	110004	PACKING, o-ring; PTFE	1
3‡		TRIGGER, gun	1
4★	15G713	NUT, air plug	1
5★	249877	DIFFUSER, assy, RAC	1
5a★		DIFFUSER, housing	1
5b✖	288619	GASKET, seat; nylon	1
5c✖		SEAT; carbide	1
5d✖		NUT, seat	1
5e*★✓	111116	PACKING, o-ring, seat; PTFE	1
5f*★✓	109450	PACKING, o-ring; PTFE	1
5g*★✓	111457	PACKING, o-ring; PTFE	1
6★	288465	TIP GUARD/AIR CAP ASSY	1
6a*★✓	109213	PACKING, o-ring, PTFE	1
7*✓	188493	PACKING, u-cup; UHMWPE	1
8*		VALVE, air, assy	1
9	15F193	SHAFT, fluid spring	1
10	15F194	SEAT, spring	1
11	15F195	CAP, spring	1
13‡	15F739	PIN, pivot	1
14‡	15F740	PIN, pivot, nut	1
15	114069	SPRING, compression	1
16	249317	TUBE, assy	1
17	15F202	FITTING, air inlet	1
19	115141	SPRING, compression	1
20	119996	SCREW, cap, socket hd; 1/4-20 x 3/8 in. (10 mm)	1
22*✓	115133	GASKET, tube, acetal	1
28*		TOOL, installation; seal	1
29	117642	TOOL, nut driver	1
30	15F446	TOOL, gun	1
31▲	222385	CARD, warning (not shown)	1
32▲	172479	TAG, warning (not shown)	1
33		SPRAY TIP, customer's choice, see tip selection chart page 31, includes item 33a	1
33a	246453	RAC GASKET, standard, black	1
	248936	RAC GASKET, solvent resistant, orange	1
35★	15J770	HOUSING, cylinder	1

▲ Replacement Danger and Warning labels, tags, and cards are available at no cost.

* Parts included in Seal Repair Kit 249422 (purchase separately).

✖ Parts included in Carbide Seat Repair Kit 249456 (purchase separately).

‡ Parts included in Trigger Repair Kit 249585 (purchase separately).

★ Parts included in RAC Conversion Kit 287917 (purchase separately).

✓ Not for sale separately.

Spray Tip Selection Chart

Spray Tips, for use with AA Series Air Cap



AAM Fine Finish Spray Tips

Recommended for *high finish quality applications at low and medium pressures*. Order desired tip (**Part No. AAMxxx**) from matrix below.

GG4 Industrial Spray Tips

Recommended for *high wear applications at high pressures*. Order desired tip (**Part No. GG4xxx**) from matrix below.

- All tips in the Spray Tip Selection Chart below can be used with Model G40 guns (249242). Use tips in the gray shaded area of the chart with Model G40 guns only.
- Do not use tips in the gray shaded area of the chart with Model G15 guns (288844).

						
SKIN INJECTION HAZARD						
Do not use tips in the gray shaded area of the Spray Tip Selection Chart with Model G15 guns (288844).						
Failure to follow this warning can result in serious injury or amputation.						

Orifice Size in. (mm)	* Fluid Output, fl oz/min (lpm)		Maximum Pattern Width at 12 in. (305 mm)								
	at 600 psi (4.1 MPa, 41 bar)	at 1000 psi (7.0 MPa, 70 bar)	2 to 4 (100)	4 to 6 (150)	6 to 8 (200)	8 to 10 (250)	10 to 12 (300)	12 to 14 (350)	14 to 16 (400)	16 to 18 (450)	18 to 20 (500)
† 0.007 (0.178)	4.0 (0.1)	5.2 (0.15)	★107	207	307						
† 0.009 (0.229)	7.0 (0.2)	9.1 (0.27)	109	209	309	409	509				
† 0.011 (0.279)	10.0 (0.3)	13.0 (0.4)	111	211	311	411	511	611			
0.013 (0.330)	13.0 (0.4)	16.9 (0.5)		213	313	413	513	613	713		
0.015 (0.381)	17.0 (0.5)	22.0 (0.7)		215	315	415	515	615	715	815	
0.017 (0.432)	22.0 (0.7)	28.5 (0.85)		217	317	417	517	617	717	817	917
0.019 (0.483)	28.0 (0.8)	36.3 (1.09)		219	319	419	519	619	719	819	919
0.021 (0.533)	35.0 (1.0)	45.4 (1.36)			321	421	521	621	721	821	921
‡ 0.023 (0.584)	40.0 (1.2)	51.9 (1.56)				423	523	623	723		923
‡ 0.025 (0.635)	50.0 (1.5)	64.8 (1.94)				425		625	725	825	
‡ 0.027 (0.686)	58.5 (1.7)	75.8 (2.27)					527	627		827	
‡ 0.029 (0.737)	68.0 (1.9)	88.2 (2.65)						629			
‡ 0.031 (0.787)	78.0 (2.2)	101.1 (3.03)				431		631			
‡ 0.033 (0.838)	88.0 (2.5)	114.1 (3.42)						633		★833	
‡ 0.035 (0.889)	98.0 (2.8)	127.1 (3.81)				435					
‡ 0.037 (0.940)	108.0 (3.1)	140.0 (4.20)							737		
‡ 0.039 (0.991)	118.0 (3.4)	153.0 (4.59)					539	639		839	

* Tips are tested in water.

Fluid output (Q) at other pressures (P) can be calculated by this formula: $Q = (0.041) (QT) \sqrt{P}$
 where QT = fluid output (fl oz/min) from the above table for the selected orifice size.

† These tip sizes include a 150 mesh tip filter.

‡ Do not use these tips with Model G15 guns (288844).

★ GG4 tips only.

RAC SwitchTips, for use with AA Series Air Cap

 All tips in the Spray Tip Selection Charts below can be used with Model 249238 G40 guns equipped with RAC air cap 288465.

 Tips are sometimes packaged with other promotional parts intended for the airless market. Disregard extra parts.

LTX RAC Spray Tips

Order desired tip (Part No. LTXxxx) from matrix below.

Orifice Size in. (mm)	* Fluid Output, fl oz/min (lpm)	❖ Maximum Pattern Width at 12 in. (305 mm)								
	at 2000 psi (14.0 MPa, 140 bar)	2 to 4 (100)	4 to 6 (150)	6 to 8 (200)	8 to 10 (250)	10 to 12 (300)	12 to 14 (350)	14 to 16 (400)	16 to 18 (450)	18 to 20 (500)
0.009 (0.229)	11.2 (0.33)		209	309						
0.011 (0.279)	16.6 (0.49)		211	311	411	511				
0.013 (0.330)	23.3 (0.69)		213	313	413	513				
0.015 (0.381)	30.8 (0.91)		215	315	415	515	615			
0.017 (0.432)	39.5 (1.17)		217	317	417	517	617			
0.019 (0.483)	49.7 (1.47)		219	319	419	519	619			
0.021 (0.533)	60.5 (1.79)			321	421	521	621	721		
0.023 (0.584)	72.7 (2.15)				423	523	623			
0.025 (0.635)	85.9 (2.54)					525	625			
0.027 (0.686)	100.0 (2.96)					527	627		827	
0.029 (0.737)	115.6 (3.42)						629			
0.031 (0.787)	131.8 (3.90)					531	631			
0.033 (0.838)	149.4 (4.42)									
0.035 (0.889)						535	635			

* *Tips are tested in water.*

Fluid output (Q) at other pressures (P) can be calculated by this formula: $Q = (0.041) (QT) \sqrt{P}$
 where QT = fluid output (fl oz/min) from the above table for the selected orifice size.

❖ *Measured with NO airflow. Air assist will tend to reduce pattern lengths by 1 in. to 2 in.*

RAC SwitchTips, for use with AA Series Air Cap Continued



- All tips in the Spray Tip Selection Charts below can be used with Model 249238 G40 guns equipped with RAC air cap 288465.

FFT Fine Finish RAC Spray Tips

Order desired tip (Part No. FFTxxx) from matrix below.

Orifice Size in. (mm)	* Fluid Output, fl oz/min (lpm)	❖ Maximum Pattern Width at 12 in. (305 mm)				
	at 2000 psi (14.0 MPa, 140 bar)	4 to 6 (150)	6 to 8 (200)	8 to 10 (250)	10 to 12 (300)	12 to 14 (350)
0.008 (0.203)	8.8 (0.26)	208	308			
0.010 (0.254)	13.9 (0.41)	210	310	410	510	
0.012 (0.305)	19.9 (0.59)	212	312	412	512	612
0.014 (0.356)	27.0 (0.80)	214	314	414	514	614

WRX WideRAC Spray Tips

Order desired tip (Part No. WRXxxx) from matrix below.

Orifice Size in. (mm)	* Fluid Output, fl oz/min (lpm)	❖ Maximum Pattern Width at 12 in. (305 mm)
	at 2000 psi (14.0 MPa, 140 bar)	24 in. (610)
0.021 (0.533)	60.5 (1.79)	1221
0.023 (0.584)	72.7 (2.15)	1223
0.025 (0.635)	85.9 (2.54)	1225
0.027 (0.686)	100.0 (2.96)	1227
0.029 (0.737)	115.6 (3.42)	1229
0.031 (0.787)	131.8 (3.90)	1231
0.033 (0.838)	149.4 (4.42)	1233
0.035 (0.889)	168.3 (4.98)	1235
0.037 (0.940)	187.9 (5.56)	1237
0.039 (0.991)	208.9 (6.18)	1239

* Tips are tested in water.

Fluid output (Q) at other pressures (P) can be calculated by this formula: $Q = (0.041) (QT) \sqrt{P}$
 where QT = fluid output (fl oz/min) from the above table for the selected orifice size.

❖ Measured with NO airflow. Air assist will tend to reduce pattern lengths by 1 in. to 2 in.

Accessories

Use Only Genuine Graco Parts and Accessories

Air Fitting and Tubing Kit 249473

Alternative-style connector for air inlet and hose. 3/8 in. to 1/4 npt(f) Push-To-Lock fitting, 25 ft (7.62 m) long, 3/8 in. (9.5 mm) ID, nylon tubing.

Air Hose 241811

100 psi (0.7 MPa, 7 bar) Maximum Working Pressure 1/4-18 npsm(fbe), 1/4 in. (6 mm) ID, 25 ft (7.62 m) long polyurethane tubing.

Air Line Quick Disconnect

208536 Air Line Quick Disconnect Coupling

169967 Air Line Quick Disconnect Pin

Fluid Filter Kits

224453 100 mesh (.005 gap spacing) replacement fluid filters. Quantity. of 5.

238563 60 mesh (.009 gap spacing) replacement fluid filters for coarser particle filtering to replace standard 100 mesh filters. Quantity of 3.

Fluid Hose 241812

3500 psi (24 MPa, 242 bar) Maximum Working Pressure 1/4-18 npsm(fbe), 3/16 in. (5 mm) ID, 25 ft (7.62 m) long, nylon tubing with polyurethane cover.

Fluid Swivel Connector 115898

5800 psi (40 MPa, 400 bar) Maximum Working Pressure Connector to ease movement of the gun and fluid hose. 1/4-18 npsm. 17-4 PH SST wetted parts.

Gun Brush 101892

Use to clean the gun.

G15 Gun Flush Box Insert 15G093

Insert for use with Gun Flush Box 244105 and AA Series G15 Spray Guns.

G40 Gun Flush Box Insert 15G346

Insert for use with Gun Flush Box 244105 and AA Series G40 Spray Guns.

Gun Lubricant 111265

One 4 oz. (113 g) tube sanitary (non-silicone) lubricant for fluid seals and wear areas.

High Pressure Fluid Ball Valve 238694

5000 psi (35 MPa, 350 bar) Maximum Working Pressure 3/8 npt(mbe). SST wetted parts, PEEK seats, PTFE seals. Compatible with acid-catalyzed materials. Can be used as fluid drain valve.

HVLP Verification Kit 249140

Use to check air cap air pressure at various air supply air pressures. **Do not use for actual spraying.**



To be HVLP compliant, the atomizing air pressure must not exceed 10 psi (70 kPa, 0.7 bar).

RAC Gasket 246453

Pack of five standard replacement RAC gaskets (item 33a).

Acetal RAC Gasket 248936

Pack of five plastic (acetal) replacement RAC gaskets (item 33a).

Tip Gasket Repair Kit 26C713

Pack of ten sealing washers.

G40 RAC Conversion Kit 287917

Kit includes parts to convert a standard G40 gun (249242) to a RAC gun. LTX spray tip not included.

Air Cap Lacquer Kit 289080

Kit includes air cap optimized to spray lacquer.

Air Cap Seal Kit 253032

Pack of five seals and five o-rings for the air cap assy.

Seal Repair Kit 249422

Kit includes replacement o-rings, gasket, u-cup, air valve assembly, and seal installation tool.

Plastic Seat Repair Kit 249424

Kit includes replacement plastic seat (pack of 10), and seat nut for Model G15 gun.

SST Seat Repair Kit 287962

Kit includes assembled diffuser with SST seat for use with pigmented acid catalyzed materials. For use with gun 288844 only.

Carbide Seat Repair Kit 249456

Kit includes replacement carbide seat, seat gasket, and seat nut for Model G40 gun. Kit also can be used with Model G15 guns.

Carbide Seat Gasket Kit 288619

Kit includes replacement nylon seat gaskets (qty. of ten) for Model G40 guns and G15 guns with a carbide seat.

Tip Filter Kit 241804

Replacement filters for spray tip orifice sizes 0.007, 0.009, and 0.011. Quantity of 10.

Trigger Repair Kit 249585

Kit includes replacement trigger, pivot pins (qty. of 5), and pivot pin nuts (qty. of 5).

Trigger Stop Kit 249423

Kit includes replacement trigger stop and pin.

Ultimate Gun Cleaning Kit 15C161

Kit includes brushes and tools for gun maintenance.

Unclogging Needle Kit 249598

Kit includes picks for unclogging gun tip.

Fan Valve Fine Adjustment Kit 289499

Kit includes a replacement fan valve assembly with more adjustment accuracy.

Technical Data

Category	Data
Maximum Working Fluid Pressure	Model G15: 1500 psi (10 MPa, 105 bar) Model G40: 4000 psi (28 MPa, 280 bar)
Maximum Working Air Pressure	100 psi (0.7 MPa, 7 bar)
Maximum Gun Inlet Air Pressure for HVLP Operation . . .	14 psi (0.098 MPa, 0.98 bar)
Maximum Working Fluid Temperature	110°F (43°C)
Fluid Inlet	1/4-18 npsm
Air Inlet	1/4-18 npsm (R1/4-19) compound male thread
Gun Weight.	16 oz (450 grams)
*Sound Pressure at 20 psi (140 kPa, 1.4 bar)	66.9 dB(A)
*Sound Pressure at 100 psi (0.7 kPa, 7 bar)	80.0 dB(A)
*Sound Power at 20 psi (140 kPa, 1.4 bar)	76.8 dB(A)
*Sound Power at 100 psi (0.7 kPa, 7 bar)	89.9 dB(A)
Wetted Parts.	Stainless Steel, Carbide, Ultra High Molecular Weight Polyethylene, Engineered Plastic, PTFE, Nylon, Fluoro-elastomer

* All readings were taken with the fan valve fully closed (full fan size), at 20 psi (140 kPa, 1.4 bar) and 100 psi (0.7 kPa, 7 bar), and at the assumed operator position. Sound Power was tested to ISO 9614-2.

Air Flow, Standard AA Series Air Cap

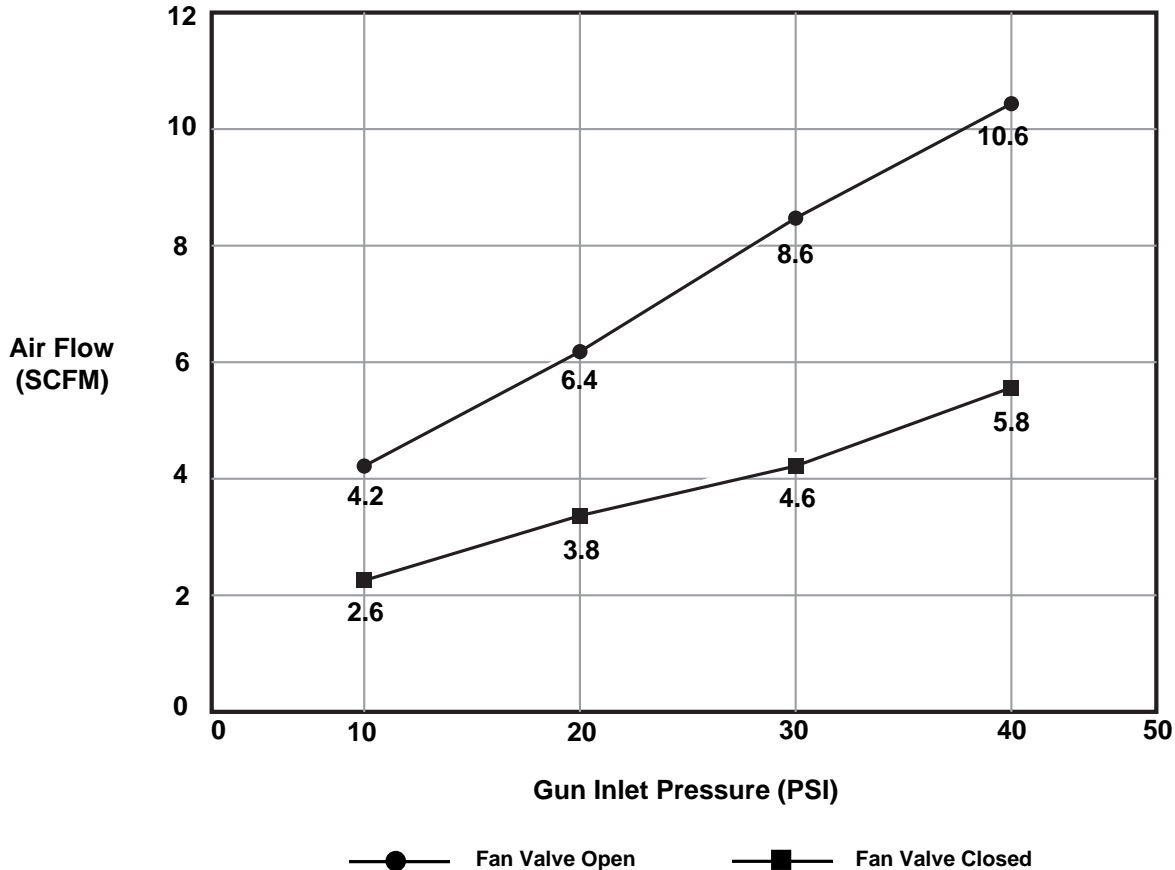

Dimensions

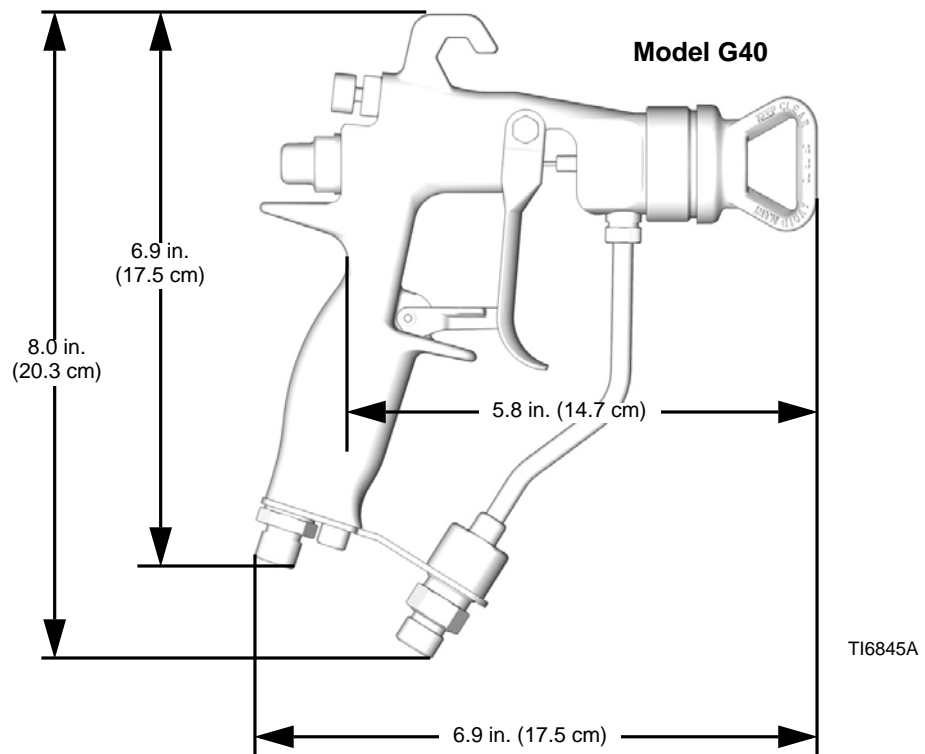
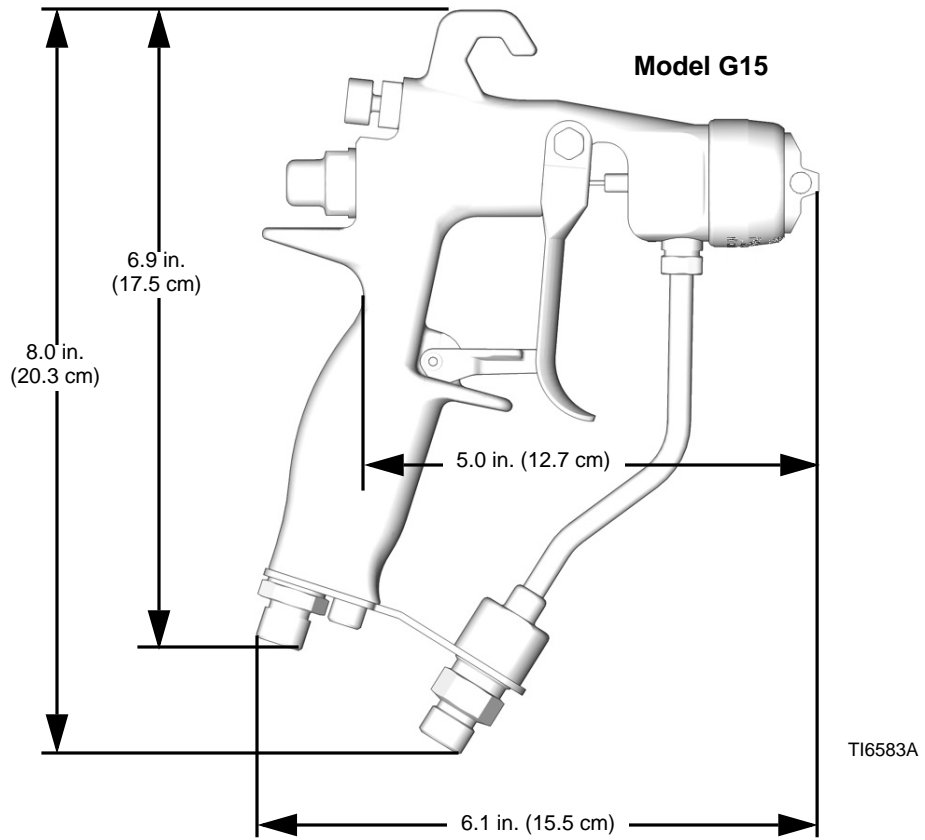

Graco Standard Warranty

Graco warrants all equipment referenced in this document which is manufactured by Graco and bearing its name to be free from defects in material and workmanship on the date of sale to the original purchaser for use. With the exception of any special, extended, or limited warranty published by Graco, Graco will, for a period of twelve months from the date of sale, repair or replace any part of the equipment determined by Graco to be defective. This warranty applies only when the equipment is installed, operated and maintained in accordance with Graco's written recommendations.

This warranty does not cover, and Graco shall not be liable for general wear and tear, or any malfunction, damage or wear caused by faulty installation, misapplication, abrasion, corrosion, inadequate or improper maintenance, negligence, accident, tampering, or substitution of non-Graco component parts. Nor shall Graco be liable for malfunction, damage or wear caused by the incompatibility of Graco equipment with structures, accessories, equipment or materials not supplied by Graco, or the improper design, manufacture, installation, operation or maintenance of structures, accessories, equipment or materials not supplied by Graco.

This warranty is conditioned upon the prepaid return of the equipment claimed to be defective to an authorized Graco distributor for verification of the claimed defect. If the claimed defect is verified, Graco will repair or replace free of charge any defective parts. The equipment will be returned to the original purchaser transportation prepaid. If inspection of the equipment does not disclose any defect in material or workmanship, repairs will be made at a reasonable charge, which charges may include the costs of parts, labor, and transportation.

THIS WARRANTY IS EXCLUSIVE, AND IS IN LIEU OF ANY OTHER WARRANTIES, EXPRESS OR IMPLIED, INCLUDING BUT NOT LIMITED TO WARRANTY OF MERCHANTABILITY OR WARRANTY OF FITNESS FOR A PARTICULAR PURPOSE.

Graco's sole obligation and buyer's sole remedy for any breach of warranty shall be as set forth above. The buyer agrees that no other remedy (including, but not limited to, incidental or consequential damages for lost profits, lost sales, injury to person or property, or any other incidental or consequential loss) shall be available. Any action for breach of warranty must be brought within two (2) years of the date of sale.

GRACO MAKES NO WARRANTY, AND DISCLAIMS ALL IMPLIED WARRANTIES OF MERCHANTABILITY AND FITNESS FOR A PARTICULAR PURPOSE, IN CONNECTION WITH ACCESSORIES, EQUIPMENT, MATERIALS OR COMPONENTS SOLD BUT NOT MANUFACTURED BY GRACO. These items sold, but not manufactured by Graco (such as electric motors, switches, hose, etc.), are subject to the warranty, if any, of their manufacturer. Graco will provide purchaser with reasonable assistance in making any claim for breach of these warranties.

In no event will Graco be liable for indirect, incidental, special or consequential damages resulting from Graco supplying equipment hereunder, or the furnishing, performance, or use of any products or other goods sold hereto, whether due to a breach of contract, breach of warranty, the negligence of Graco, or otherwise.

FOR GRACO CANADA CUSTOMERS

The Parties acknowledge that they have required that the present document, as well as all documents, notices and legal proceedings entered into, given or instituted pursuant hereto or relating directly or indirectly hereto, be drawn up in English. Les parties reconnaissent avoir convenu que la rédaction du présente document sera en Anglais, ainsi que tous documents, avis et procédures judiciaires exécutés, donnés ou intentés, à la suite de ou en rapport, directement ou indirectement, avec les procédures concernées.

Graco Information

TO PLACE AN ORDER, contact your Graco distributor or call to identify the nearest distributor.

Phone: 612-623-6921 **or Toll Free:** 1-800-328-0211, **Fax:** 612-378-3505

*All written and visual data contained in this document reflects the latest product information available at the time of publication.
Graco reserves the right to make changes at any time without notice.*

This manual contains English. MM 311001

Graco Headquarters: Minneapolis

International Offices: Belgium, China, Japan, Korea

GRACO INC. P.O. BOX 1441 MINNEAPOLIS, MN 55440-1441

www.graco.com

Revision J, February 2020