

Cordless Hand-Held Paint Sprayers

3A2589F
EN

**- For portable spray applications of architectural paints and coatings only -
- Not approved for use in explosive atmosphere locations -**



IMPORTANT SAFETY INSTRUCTIONS

Read all warnings and instructions in this manual and related manuals. Be familiar with the controls and the proper usage of the equipment. Save these instructions.

All Models:

Maximum Working Pressure 2000 psi (14 MPa, 138 bar)

Model	Charger Voltage	
16N657	120V	✓
16M886	120V	✓
24R747	120V	✓



t118875b

WARNING



FIRE AND EXPLOSION HAZARD

- Use only non-flammable or water-based materials, or non-flammable paint thinners. Do not use materials having flash points lower than 100°F (38°C). This includes, but is not limited to, acetone, xylene, toluene, and naphtha. For more information about your material, request Safety Data Sheet (SDS) from the supplier.
- Use oil-based material outdoors or in a well-ventilated indoor area with a flow of fresh air.
- Spraying certain materials may cause static build-up in the sprayer that can result in static shock to the user. If this occurs, first ensure the material has a flash point greater than 100° F (38° C) and does not state that it is FLAMMABLE anywhere on the package. If static shock still occurs, the material likely contains a flammable solvent such as, but not limited to, xylene, toluene, or naphtha, which can build up static. Switch to an alternative material.

Table of Contents

Important User Information	2	Getting Started with Basic Techniques	14
Warnings	3	Triggering Sprayer	14
Component Identification	5	Aiming Sprayer	15
Battery and Charger	6	Spray Pattern Quality	15
Battery Disposal	6	Unclogging Spray Tip/Guard Assembly	15
Charging the Battery	6	Shutdown and Cleaning	16
Charger Status Indicator Lights	7	Flushing Sprayer	16
Sprayer Status Indicator Light	7	Cleaning Sprayer Exterior	18
Common Procedures	8	Storage	18
Trigger Lock	8	General Service	19
Prime/Spray Valve	8	Wiring	19
Pressure Relief Procedure	8	Pressure Control Knob	19
Reversible Spray Tip	9	Replacement Parts	20
Pressure Control Knob	9	Models 16M886, 16N657, 24R747	20
Flexible Suction Tube	10	Parts List - Models 16N657, 16M886, 24R747	21
Sprayer Setup	11	Parts List - Models 16N657, 16M886, 24R747(Continued)	22
Starting a New Job		Inlet Valve Fitting Removal/Service	23
(or Refilling the Material Cup)	12	Outlet Valve Fitting Repair	24
Choosing the Correct Tip	13	Troubleshooting	25
Understanding Tip Number	13	Troubleshooting Leaks	29
Selecting Tip Hole Size	13	Technical Data	30
Choosing Pressure Control Knob Setting	13	Preferred Material Settings Log	31
Install Spray Tip/Guard		Graco Standard Warranty	32
Assembly (if not installed)	14		

Important User Information

Before using your sprayer read this Operation manual for complete instructions on proper use and safety warnings.

DO NOT RETURN THIS SPRAYER TO THE STORE!

If you experience problems, contact Graco Product Support at 1-888-541-9788 or visit www.graco.com.

Congratulations! You have purchased a high-quality sprayer made by Graco Inc. This sprayer is designed to provide superior spray performance with architectural paints and coatings. This user information is intended to help you understand the types of materials that can be used with your sprayer.

Before using this equipment, be sure to read and follow the information on your container label and ask for a Safety Data Sheet (SDS) from your supplier. The container label and SDS will explain the contents of the material and the specific precautions related to it.

Paints, coatings and clean-up materials generally fit into one of the following **3 basic categories**:



WATER-BASED: The container label should indicate that the material can be cleaned up with soap and water. Your sprayer is compatible with this type of material. Your sprayer is **NOT** compatible with harsh cleaners such as chlorine bleach.







OIL-BASED: The container label should indicate that the material is combustible and can be cleaned up with mineral spirits or non-flammable paint thinner. The SDS must indicate that the flash point of the material is above 100° F. Your sprayer is compatible with this type of material. Use oil-based material outdoors or in a well-ventilated indoor area with a flow of fresh air. See the safety warnings in this manual.













FLAMMABLE: This type of material contains flammable solvents such as xylene, toluene, naphtha, MEK, lacquer thinner, acetone, denatured alcohol, and turpentine. The container label should indicate that this material is **FLAMMABLE**. This type of material is **NOT** compatible with your sprayer and **CANNOT** be used.

Warnings

The following warnings are for the setup, use, maintenance, and repair of this equipment. The exclamation point symbol alerts you to a general warning and the hazard symbols refer to procedure-specific risks. When these symbols appear in the body of this manual or on warning labels, refer back to these Warnings. Product-specific hazard symbols and warnings not covered in this section may appear throughout the body of this manual where applicable.

 WARNING	
	<p>FIRE AND EXPLOSION HAZARD</p> <p>Flammable fumes, such as solvent and paint fumes, in work area can ignite or explode. To help prevent fire and explosion:</p> <ul style="list-style-type: none"> • Sprayer generates sparks. Do not spray or flush with flammable liquids. • Use only non-flammable or water-based materials, or non-flammable paint thinners. • Keep spray area well-ventilated. Keep a good supply of fresh air moving through the area. • When spraying oil-based material, use outdoors or in a well-ventilated indoor area with a flow of fresh air. • Do not spray or flush with combustible materials near an open flame or sources of ignition. • Paint or solvent flowing through the equipment is able to result in static electricity. Static electricity creates a risk of fire or explosion in the presence of paint or solvent fumes. • Keep sprayer at least 10 in. (25 cm) away from objects while spraying or flushing. • Verify all containers and collection systems are grounded to prevent static discharge. • Connect to a grounded outlet and use grounded extension cords. Do not use a 3 to 2 adapter. • Do not use paints or solvents containing halogenated hydrocarbons. • Do not smoke in the spray area. • Do not operate light switches, engines, or similar spark producing products in the spray area. • Keep area clean and free of paint or solvent containers, rags, and other flammable materials. • Know the contents of the paints and solvents being sprayed. Read all Safety Data Sheets (SDS) and container labels provided with the paints and solvents. Follow the paint and solvents manufacturer's safety instructions. • Fire extinguisher equipment shall be present and working.
	<p>SKIN INJECTION HAZARD</p> <p>High-pressure spray is able to inject toxins into the body and cause serious bodily injury. In the event that injection occurs, get immediate surgical treatment.</p> <ul style="list-style-type: none"> • Do not aim the sprayer at, or spray any person or animal. • Keep hands and other body parts away from the discharge. For example, do not try to stop leaks with any part of the body. • Always use the nozzle tip guard. Do not spray without nozzle tip guard in place. Use Graco nozzle tips. • Use caution when cleaning and changing nozzle tips. In the case where the nozzle tip clogs while spraying, remove battery and follow the Pressure Relief Procedure for relieving the pressure before removing the nozzle tip to clean. • Do not leave the equipment energized or under pressure while unattended. Remove battery and follow the Pressure Relief Procedure when the equipment is unattended or not in use, and before servicing, cleaning, or removing parts. • Check parts for signs of damage. Replace any damaged parts. • This system is capable of producing 2000 psi. Use replacement parts or accessories that are rated a minimum of 2000 psi. • Always engage the trigger lock when not spraying. Verify the trigger lock is functioning properly. Do not carry the tool with a finger on the trigger. • Verify that all connections are secure before operating the unit. • Know how to stop the unit and bleed pressure quickly. Be thoroughly familiar with the controls.
	<p>EQUIPMENT MISUSE HAZARD</p> <p>Misuse can cause death or serious injury.</p> <ul style="list-style-type: none"> • Always wear appropriate gloves, eye protection, and a respirator or mask when painting. • Do not operate or spray near children. Keep children away from equipment at all times. • Do not operate the unit unless mentally and physically capable of following the equipment instructions. • Do not overreach or stand on an unstable support. Keep effective footing and balance at all times. • Stay alert and watch what you are doing. • Do not operate the unit when fatigued or under the influence of drugs or alcohol. • Do not alter or modify equipment. Alterations or modifications may void agency approvals and create safety hazards. • Make sure all equipment is rated and approved for the environment in which you are using it.

! WARNING

	<p>BATTERY HAZARD</p> <p>The battery may leak, explode, cause burns, or cause an explosion if mishandled. Contents of an open battery can cause severe irritation and/or chemical burns. If on skin, wash with soap and water. If in eyes, flush with water for at least 15 minutes and get immediate medical attention.</p> <ul style="list-style-type: none"> • Replace battery only in a well-ventilated area and away from flammable or combustible materials, including paints and solvents. • When battery is not in use, keep it away from metal objects like keys, nails, screws or other metal objects that can short circuit the battery terminals. • Do not throw into fire. • Charge only with Graco approved charger as listed in this manual. • Do not store at temperatures below 32° or above 113°F (0° to 45°C). • Do not use at temperatures below 40° or above 90° F (4° to 32°C). • Do not expose battery to water or rain. • Do not disassemble, crush, or penetrate the battery. • Do not use or charge a battery that is cracked or damaged. • Follow local ordinances and/or regulations for disposal.
    	<p>CHARGER ELECTRIC SHOCK, FIRE AND EXPLOSION HAZARD</p> <p>Improper setup or usage can cause electric shock, fire, and explosion.</p> <ul style="list-style-type: none"> • Charge only in a well-ventilated area and away from flammable or combustible materials, including paints and solvents. • Do not charge on a combustible or flammable surface. • Do not leave battery unattended while charging. • Immediately unplug charger and remove battery when charging is complete. • Charge only Graco approved batteries listed in this manual; other batteries may burst. • Use only in dry locations. Do not expose to water or rain. • Do not use a charger that is cracked or damaged. • If the supply cord is damaged, replace the charger or cord, depending on model. • Never force the battery into the charger. • Disconnect the charger from the outlet before cleaning. • Ensure that the outside surface of the battery is clean and dry before plugging into the charger. • Do not attempt to charge non-rechargeable batteries. • Do not disassemble the charger. Take charger to authorized service center when service or repair is required.
	<p>PRESSURIZED ALUMINUM PARTS HAZARD</p> <p>Use of fluids that are incompatible with aluminum in pressurized equipment can cause serious chemical reaction and equipment rupture. Failure to follow this warning can result in death, serious injury, or property damage.</p> <ul style="list-style-type: none"> • Do not use 1,1,1-trichloroethane, methylene chloride, other halogenated hydrocarbon solvents or fluids containing such solvents. • Do not use chlorine bleach. • Many other fluids may contain chemicals that can react with aluminum. Contact your material supplier for compatibility.
 	<p>MOVING PARTS HAZARD</p> <p>Moving parts can pinch, cut, or amputate fingers and other body parts.</p> <ul style="list-style-type: none"> • Keep clear of moving parts. • Do not operate equipment with protective guards or covers removed. • Pressurized equipment can start without warning. Before checking, moving, or servicing equipment, follow the Pressure Relief Procedure in this manual and remove battery.
	<p>TOXIC FLUID OR FUMES HAZARD</p> <p>Toxic fluids or fumes can cause serious injury or death if splashed in the eyes or on skin, inhaled, or swallowed.</p> <ul style="list-style-type: none"> • Read Safety Data Sheet (SDS) to know the specific hazards of the fluids you are using. • Store hazardous fluid in approved containers, and dispose of it according to applicable guidelines.
	<p>PERSONAL PROTECTIVE EQUIPMENT</p> <p>Wear appropriate protective equipment when in the work area to help prevent serious injury, including eye injury, hearing loss, inhalation of toxic fumes, and burns. This protective equipment includes but is not limited to:</p> <ul style="list-style-type: none"> • Protective eyewear, and hearing protection. • Respirators, protective clothing, and gloves as recommended by the fluid and solvent manufacturer.
	<p>CALIFORNIA PROPOSITION 65</p> <p>This product contains a chemical known to the State of California to cause cancer, birth defects or other reproductive harm. Wash hands after handling.</p>

Component Identification

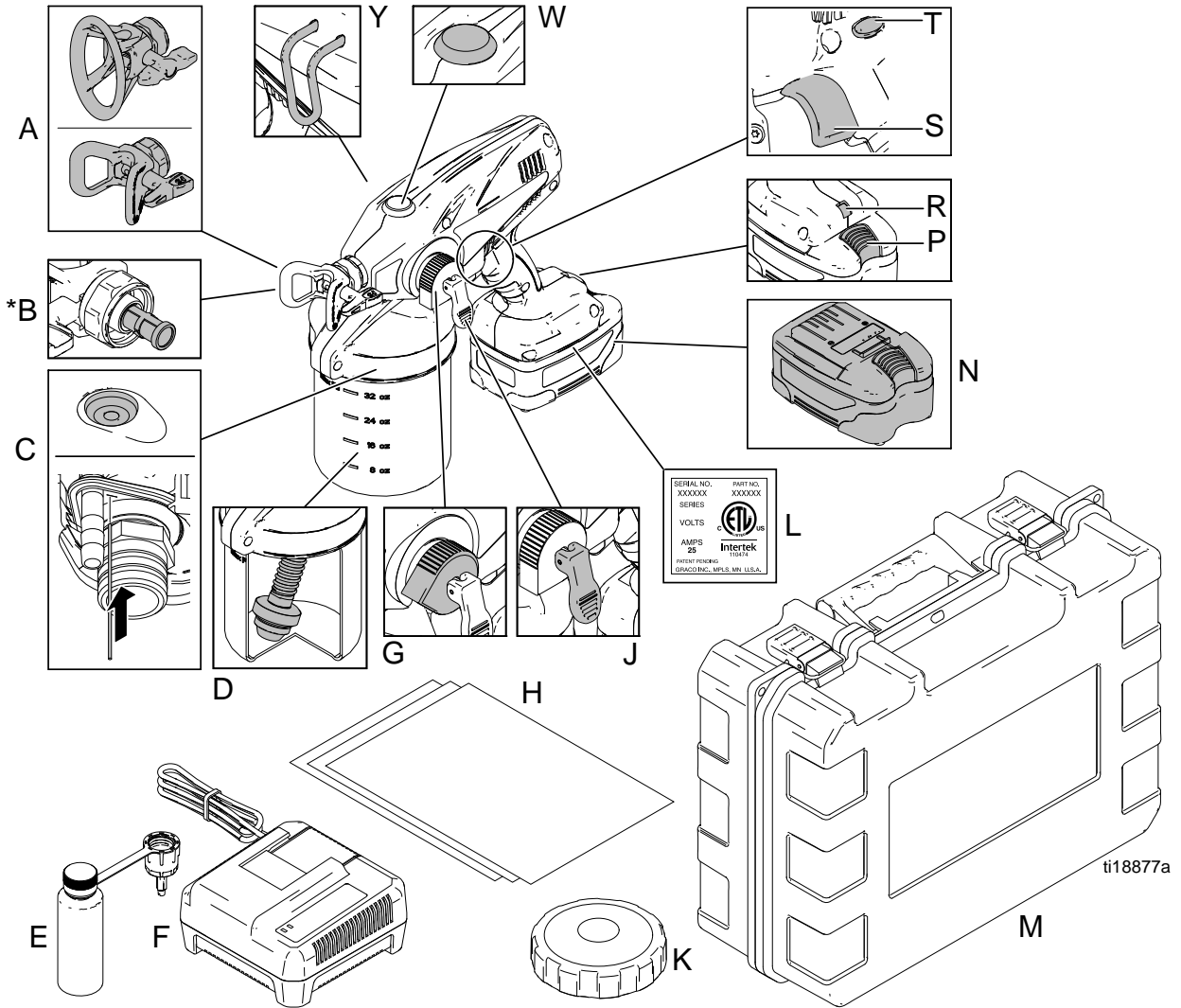

A	Spray Tip/Guard Assembly
*B	Spray Tip Filter (Reverse Threaded)
C	Air Vent Valve
D	Flexible Suction Tube
E	Pump Armor Storage/Startup Tool
F	Battery Charger and power cord
G	Pressure Control Knob
H	Material Cup Liners (5 included)
J	Prime/Spray Valve
K	Material Cup Cover and Seal

L	Part Number = Model Number
M	Sprayer Case
N	Battery
P	Battery Release Button
R	Sprayer Status Indicator Light
S	Trigger
T	Trigger Lock
W	Outlet Valve Fitting Access Plug
Y	Sprayer Hook (Not available on all models)

***NOTE:** Spray Tip filter is reverse-threaded. Turn left (or counter-clockwise) to tighten, turn right (or clockwise) to loosen.

Battery and Charger

- **Lithium Battery Packs:** Batteries are low maintenance. They can be used at any charge level without creating a memory effect.
- **Battery Protection Features:** Battery is designed with protection features to maximize battery life. If sprayer stops during operation refer to the sprayer and battery indicator lights to determine proper action.
- **Battery Run Time:** To maximize battery run time, spray with; lower pressure. larger tips, thicker materials, and at cooler temperatures.
- **Charging a Hot or Cold Battery:** The battery may be immediately placed into the charger. Charging will not start until battery temperature is within the allowed temperature range. Charging will begin automatically when the battery is within the allowed temperature range.
- **Cold Weather Battery Operation:** Batteries may be used in cold temperatures. However, if sprayer light indicates battery is too cold, you may warm the battery by operating the sprayer in prime mode with water for a minute. Once battery warms to operating temperature, sprayer will operate normally
- **Battery Storage:** To maximize battery life between uses, store batteries with a full charge in temperatures between 32 – 70° F (0 – 22° C) in a low humidity environment. Store batteries at full charge.
- **Battery Replacement:** If a battery has been fully charged and will not spray more than one cup of material or the sprayer will not run, the battery needs to be replaced.

Battery Disposal

Do not place batteries in the trash. To find a recycling location in the USA and Canada call 1-800-822-8837 or go to www.call2recycle.org.

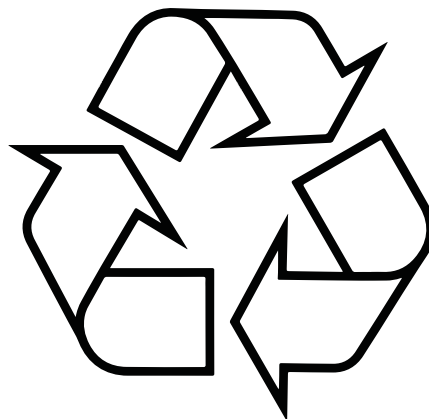
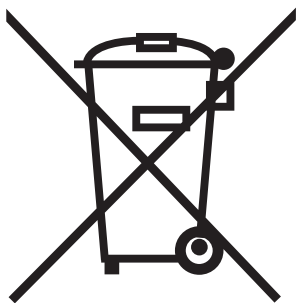

ti25930a

Charging the Battery

<p>Replace and charge battery only in a well-ventilated area and away from flammable or combustible materials, including paints and solvents.</p>		

Batteries are partially charged to provide optimum battery life and require charging before first use. It takes approximately 45 minutes to charge a dead battery to 80%, at which point it can be used. It will take approximately 75 minutes to fully charge a dead battery.

1. Place charger in a dry, well-ventilated area and away from flammable or combustible materials, including paints and solvents.



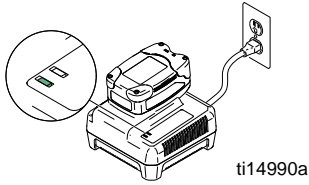

Battery and Charger

2. Plug charger into an electrical outlet and slide battery into charger as shown (light will turn on in 5 seconds).
3. When battery becomes fully charged, immediately unplug the charger from the power supply and remove the battery from the charger.

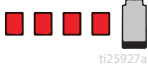

Charger Status Indicator Lights

NOTE: When the charger is plugged in, the charger status indicator lights will alternate between green and red several times before they turn off, indicating that the charger is ready to charge a battery.

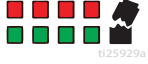
Label	Appearance	Description
	Solid green light	Indicates a full charge. Battery can be used.
	Flashing green light	Battery is charging, indicates 80% charge. Battery can be used.
	Flashing red light	Battery is charging, indicates less than 80% charge. Do NOT use battery.
	Solid red light	Battery is too hot or too cold to charge. Remove battery and allow to cool or warm up before charging.
	Alternating green/red lights	If flashing stops when battery is removed this indicates the battery needs to be replaced. If flashing continues after battery is removed replace charger.

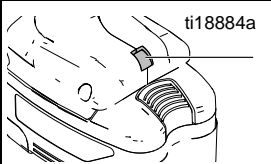

Sprayer Status Indicator Light

Light*	Appearance	Description
	No light	Normal operation.
	Solid red	Battery is low on power and needs to be charged, or battery is too cold and must warm up before spraying.
	Flashing red	Battery temperature is too high, or spray tip is clogged. See Troubleshooting , page 25.

***NOTE:** The sprayer status indicator light is only visible when sprayer trigger is engaged. You must **squeeze and hold the trigger** to see the sprayer status indicator.

Common Procedures

Trigger Lock

			
<p>Always engage the trigger lock when you stop spraying to prevent the sprayer from being triggered accidentally by hand, or if dropped or bumped.</p>			

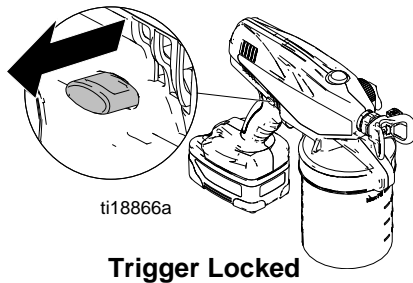

Trigger Locked

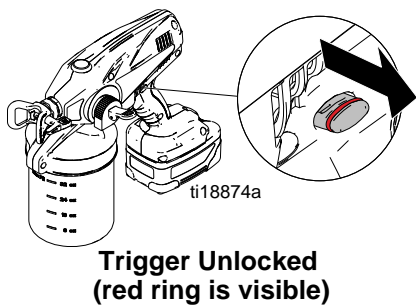

**Trigger Unlocked
(red ring is visible)**



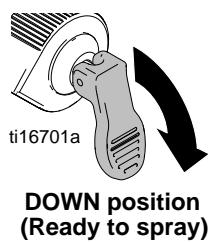
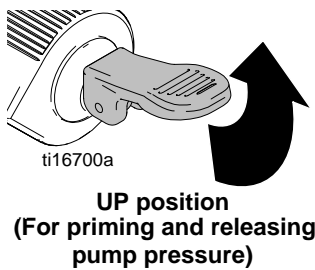

Prime/Spray Valve

				
---	---	---	---	--



 Follow the **Pressure Relief Procedure** whenever you see this symbol.

Pressure Relief Procedure

				
<p>Do not operate or spray near children. Do not aim the sprayer at, or spray any person or animal. Keep hands and other body parts away from the discharge. For example, do not try to stop the paint flow with any part of the body.</p> <p>This sprayer builds up an internal pressure of 2000 psi (14 MPa, 138 bar) during use. Remove battery and follow this Pressure Relief Procedure whenever you stop spraying and before cleaning, checking, servicing, or transporting equipment to prevent serious injury.</p>				



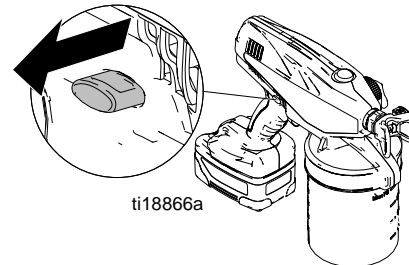

1. Engage trigger lock.

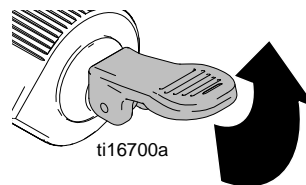

2. Put prime/spray valve UP to release pressure.



Reversible Spray Tip

				
Always perform Pressure Relief Procedure before adjusting spray tip position.				

In the event that particles or debris clog the spray tip, this sprayer is designed with a reversible spray tip that can be used to quickly and easily clear the particles and resume spraying as quickly as possible.

- Always point the reversible spray tip forward when spraying.
- When particles or debris get caught in the tip, it can be reversed to quickly clean the tip.
- See **Unclogging Spray/Tip Guard Assembly** (page 15) for detailed instructions.

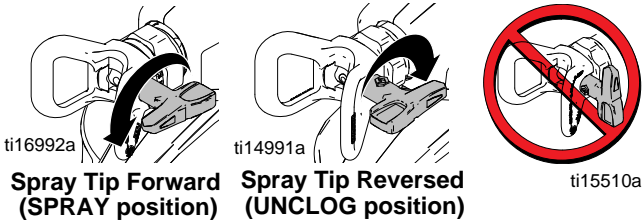

Pressure Control Knob

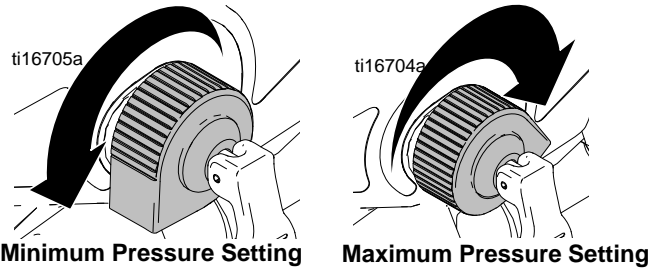

- To reduce overspray, always spray at lowest pressure that results in an acceptable spray pattern.
- Spray test pattern and adjust pressure to get desired coverage.
- With some materials, if pressure is set too low, no material may spray out. Turn pressure control knob up.
- Thin materials sprayed at high pressure settings may cause the sprayer to enter an operational mode designed to protect it from overheating. This mode is noticeable by the sprayer sounding like it is slowing down and will result in a poor spray pattern. **To exit this mode, turn pressure control knob down to lowest pressure setting that results in an acceptable spray pattern.**
- If spraying in low pressure range, there may not be enough pressure to clear the plug. Turn pressure control knob up to clear the plug.

NOTICE
See Choosing Pressure Control Knob Setting on page 13 for recommendations on the setting for your job.

Flexible Suction Tube

This sprayer comes with a flexible suction tube for multi-directional spraying without adjustment.

To ensure proper function of flexible suction tube, orient as shown. Make sure tab from sprayer is aligned with groove from flexible suction tube and firmly push into place.

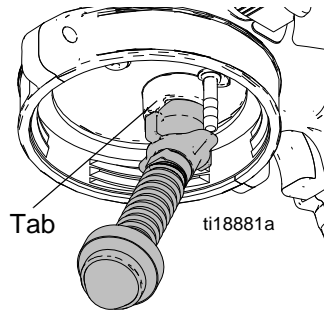

NOTE: If the sprayer is angled or tilted too far, the flexible suction tube will lose contact with the material and the sprayer will stop spraying.



Sprayer Setup



Use only non-flammable or water-based materials, or non-flammable paint thinners. Do not use materials having flash points lower than 100°F (38°C).

For more information about your material, request Safety Data Sheet SDS from the supplier.

Spraying certain materials may cause static build-up in the sprayer that can result in static shock to the user. If this occurs, first ensure the material has a flash point greater than 100° F (38° C) and does not state that it is **FLAMMABLE** anywhere on the package. If still feeling a static shock, the material likely contains a flammable solvent such as, but not limited to, xylene, toluene, or naphtha, which can build up static. Switch to an alternative material.

Use oil-based material outdoors or in a well-ventilated indoor area with a flow of fresh air.

Keep spray area well-ventilated. Keep a good supply of fresh air moving through the area.

NOTICE

Your sprayer is **NOT** compatible with harsh cleaners such as chlorine bleach. Using these cleaners will cause damage to the sprayer.

This sprayer arrives from the factory with a small amount of test material in the system. **It is important that you flush this material from the sprayer before using it for the first time:**

1. Fill material cup with water or compatible solvent, thread onto sprayer and hand tighten.

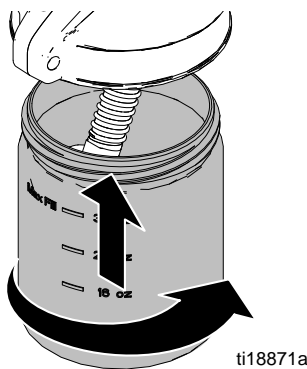

2. Put prime/spray valve to UP position, then hold trigger in for 10 seconds.

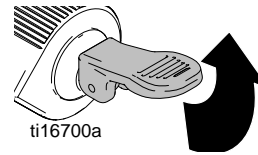

3. Put prime/spray valve DOWN to spray position.

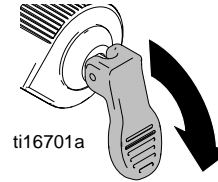

4. Reverse Spray Tip to UNCLOG position and trigger sprayer into a waste area for 10 seconds.

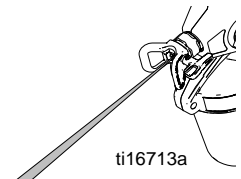
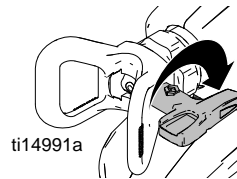

5. Engage trigger lock and put prime/spray valve UP to release pressure.

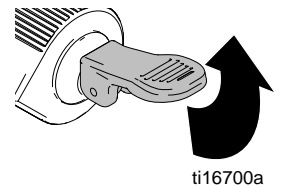
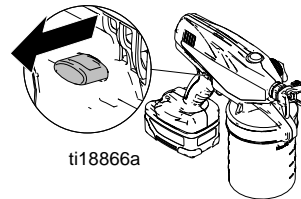

6. Unscrew and remove material cup.
7. Disengage trigger lock, hold sprayer slightly above material cup, and pull trigger to discharge fluid from pump.

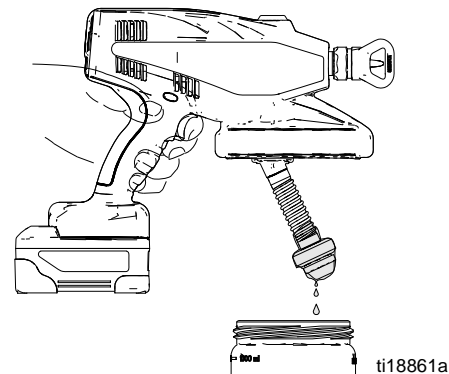

8. Discard material in cup.

Starting a New Job (or Refilling the Material Cup)

1. Engage trigger lock and put prime/spray valve UP to release pressure.

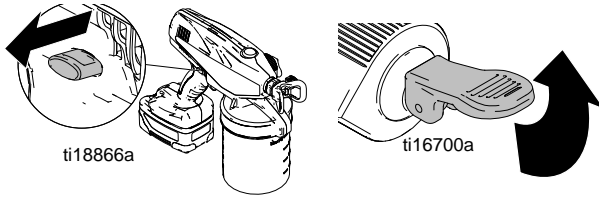

2. Install material cup liner, fill with material, and thread onto sprayer.

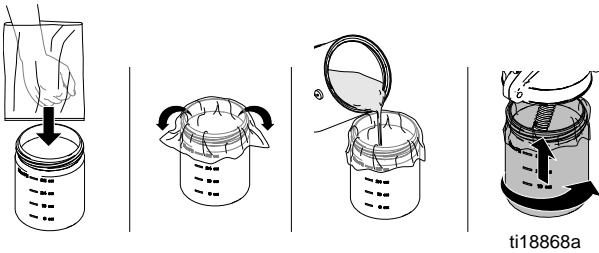

3. To fill sprayer with fluid, disengage trigger lock and trigger sprayer for 10 seconds. Then release trigger and put prime/spray valve DOWN to spray position.

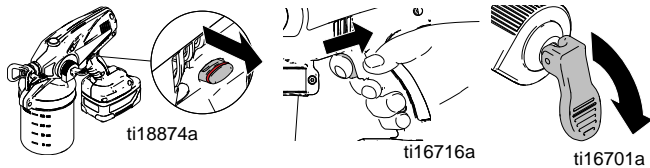

4. Reverse spray tip to UNCLOG position, pull trigger and release.

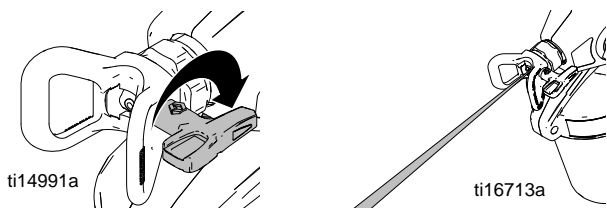

5. Put prime/spray valve UP to release pressure. Then rotate spray tip back to spray position.
NOTE: Failure to perform this operation could result in poor spray pattern.

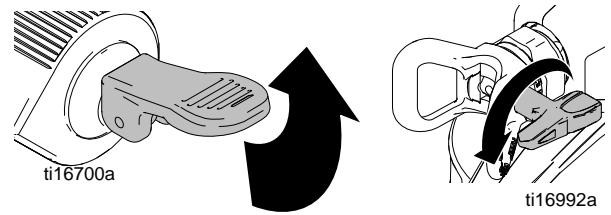

If sprayer fails to prime, try one of the steps below:

1. Use the Pump Armor storage/startup tool to clean the inlet valve fitting. See **Storage**, page 18.

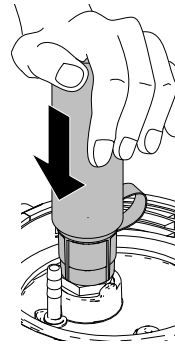

2. Clean air vent holes or the air vent valve, depending on model. See **Shutdown and Cleaning**, page 16.

Remove air vent valve, clean, and reinstall.

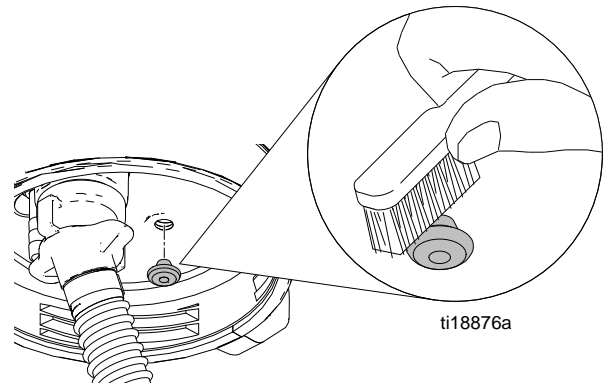

Choosing the Correct Tip

Understanding Tip Number

The last three digits of tip number (i.e.: XXX413) contains information about hole size and fan width on surface when gun is held 12 in. (30.5 cm) from surface being sprayed.

First digit when doubled = approximate fan width

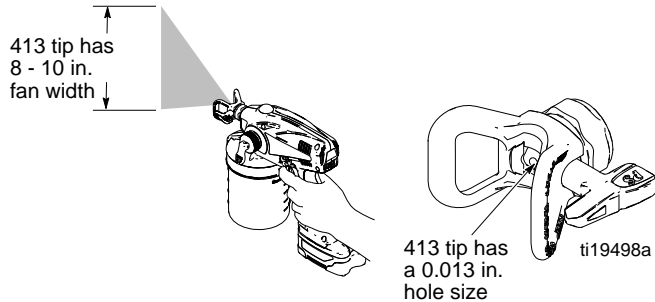

Last two digits = tip hole size in thousands of an inch

Example: For a 6 - 8 in. (152 - 203 mm) fan width and a 0.015 in (0.38 mm) hole size, order part number PST315 or NAR315, depending on your sprayer model number.

Selecting Tip Hole Size

- Tips come in a variety of hole sizes for spraying a range of fluids. The sprayer includes a 0.015 in. (0.38 mm) tip for use in most spraying applications. Use the table below to determine the range of recommended tip hole sizes for each fluid type.
- Consider coating and surface to be sprayed. Make sure to use the best tip hole size for the coating and best fan width for that surface.
- Tip hole size controls flow rate - the amount of paint that comes out of the gun.

HINTS:

- As you spray, the tip wears and enlarges. Starting with a tip hole size smaller than the maximum will allow you to spray within the rated flow capacity of the sprayer.
- Tips wear with use and abrasive paint and need periodic replacement.
- Do not spray with worn spray tips. Poor spray pattern quality will result.

Choosing Pressure Control Knob Setting

Recommendations of a starting point for determining the best set point for your sprayer and particular coating are shown in the table below.

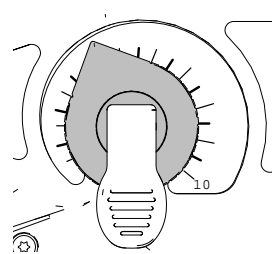
Tip Hole Size	Coatings ← → Thinner → Thicker				
	Stains	Enamels	Primers	Interior Paints	Exterior Paints
.011 in. (0.28 mm)	✓				
.013 in. (0.33 mm)	✓	✓	✓	✓	
.015 in. (0.38 mm)		✓	✓	✓	✓
.017 in. (0.43 mm)			✓	✓	✓
Pressure Control Knob Setting Number 	0 - 2	3 - 7	4 - 10	4 - 10	4 - 10

Install Spray Tip/Guard Assembly (if not installed)



This equipment stays pressurized until pressure is manually relieved. To help prevent serious injury from pressurized fluid, such as skin injection, splashing fluid and moving parts, follow the **Pressure Relief Procedure** when you stop spraying and before cleaning, checking, or servicing the equipment.

- Engage trigger lock and put prime/spray valve UP to release pressure.

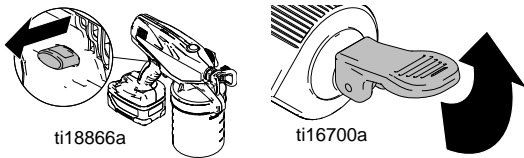

- Install filter to spray/tip guard assembly. **NOTE:** Spray tip filter is reverse-threaded. **Turn left** (or counter-clockwise) to install. **Turn right** (or clockwise) to remove.

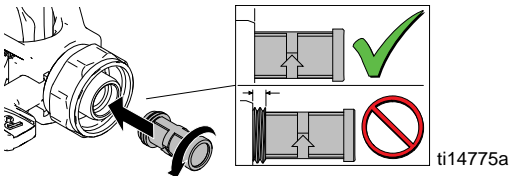

NOTICE

Make sure spray tip filter is completely screwed into the spray/tip guard assembly to avoid damage to the filter. Do not use a damaged filter or poor sprayer performance may result.



Do NOT place hands in front of tip.

- Screw spray/tip guard assembly onto sprayer. Tighten retaining nut until completely engaged with sprayer. Do not overtighten nut.

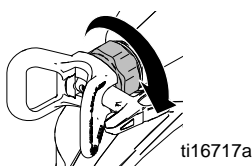

NOTICE

The spray tip is permanently attached to the spray/tip guard assembly. Removal will result in damage.

Getting Started with Basic Techniques

Use a piece of scrap cardboard to practice these basic spraying techniques before you begin spraying the surface.

- Hold sprayer 10 in. (25 cm) from surface and aim straight at surface. Tilting sprayer to direct spray angle causes an uneven finish.

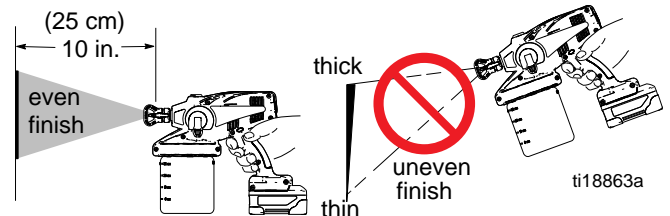

- Flex wrist to keep sprayer pointed straight. Fanning sprayer to direct spray at angle causes uneven finish.

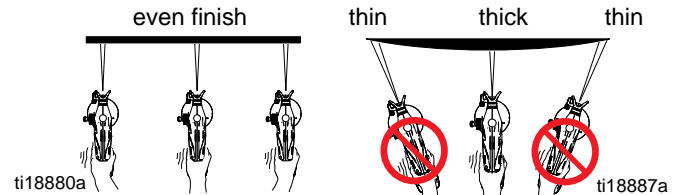

NOTE: How fast you move the sprayer will affect spray application. If material is pulsating, you are moving too fast. If material drips, you are moving too slow. See **Troubleshooting**, page 25.

Triggering Sprayer

Pull trigger after starting stroke. Release trigger before end of stroke. Sprayer must be moving when trigger is pulled and released.

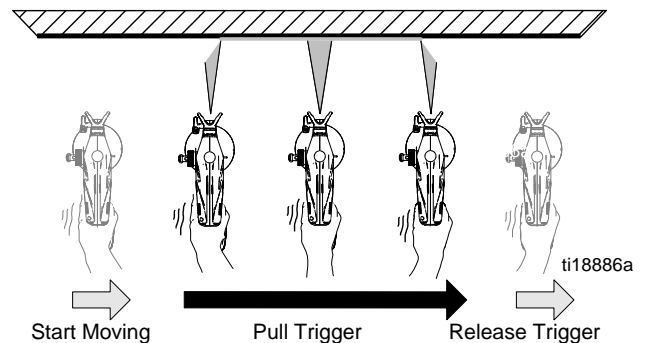

Aiming Sprayer

Aim sprayer at bottom edge of previous stroke, overlapping each stroke by half.

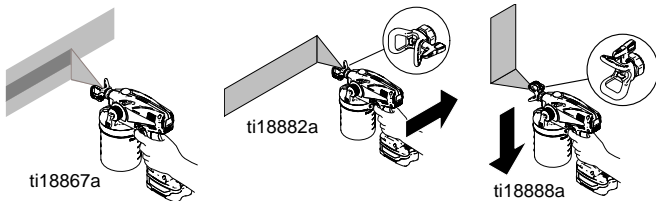

Spray Pattern Quality

A good spray pattern is evenly distributed as it hits the surface. Adjust pressure control knob so pressure is just high enough to spray without “tails”. If tails persist at highest pressure setting, a smaller tip is needed to spray the material or material may need to be thinned.

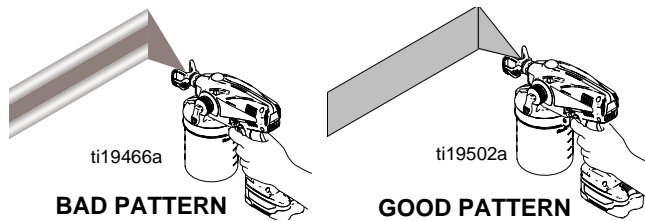

Unclogging Spray Tip/Guard Assembly

<p>Do not operate or spray near children. Do not aim the sprayer at, or spray any person or animal. Keep hands and other body parts away from discharge. For example, do not try to stop leaks with any part of the body.</p>			

1. To unclog spray tip clog, engage trigger lock and put prime/spray valve UP to release pressure.



2. Reverse spray tip to UNCLOG position. Turn pressure control knob to maximum pressure setting.

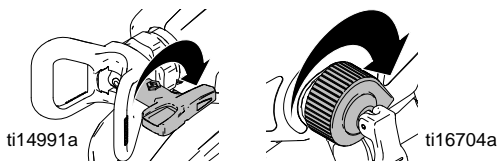

3. Aim sprayer at waste area, disengage trigger lock, and put prime/spray valve DOWN to spray position. Pull trigger to clear clog.

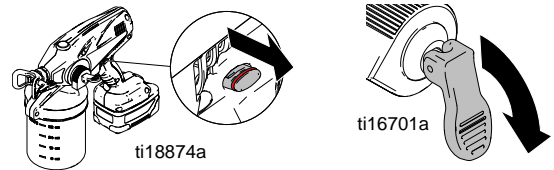

4. Engage trigger lock. Put prime/spray valve UP to release pressure and rotate spray tip back to SPRAY position.

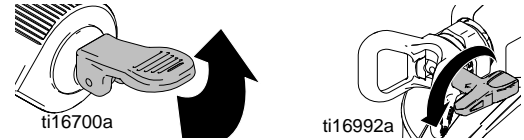

5. Disengage trigger lock, put prime/spray valve DOWN to spray position, and resume spraying.

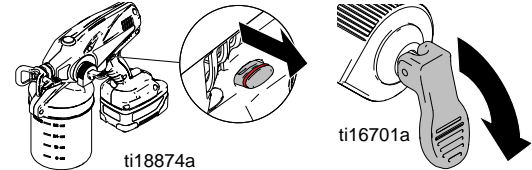

6. If spray tip is still clogged, you may have to repeat steps 1 - 5 and rotate the spray tip from SPRAY to UNCLOG several times. Repeat step 1 to release pressure, remove and clean spray tip filter, or replace with new spray tip/guard assembly.

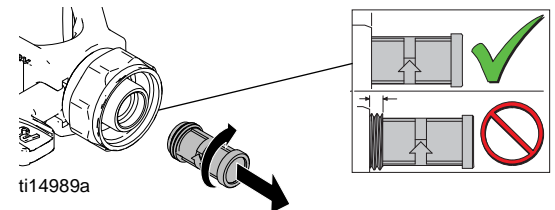

NOTE: Spray tip filter assembly is reverse-threaded:
Turn left (or counter-clockwise) to install.
Turn right (or clockwise) to remove.

NOTICE

Make sure spray tip filter is completely screwed into the spray/tip guard assembly to avoid damage to the filter. Do not use a damaged filter or poor sprayer performance may result.

7. When obstruction is cleared, engage trigger lock and rotate spray tip back to SPRAY position.

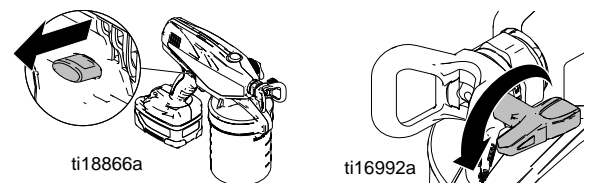

Shutdown and Cleaning

NOTICE

Failure to properly clean sprayer after each use will result in hardened materials, damage to the sprayer, and the warranty will no longer be valid. Do not store solvents other than mineral spirits in sprayer. Always flush with Graco Pump Armor prior to storage.

Flushing Sprayer

			
<p>Use only non-flammable or water-based materials, or non-flammable paint thinners. Do not use materials having flash points lower than 100°F (38°C). For more information about your material, request Safety Data Sheet (SDS) from the supplier.</p> <p>Spraying certain materials may cause static build-up in the sprayer that can result in static shock to the user. If this occurs, first ensure the material has a flash point greater than 100° F (38° C) and does not state that it is FLAMMABLE anywhere on the package. If still feeling a static shock, the material likely contains a flammable solvent such as, but not limited to, xylene, toluene, or naphtha, which can build up static. Switch to an alternative material.</p> <p>Use oil-based material outdoors or in a well-ventilated indoor area with a flow of fresh air.</p> <p>Keep spray area well-ventilated. Keep a good supply of fresh air moving through the area.</p>			

NOTICE

Protect the internal parts of this sprayer from water. Do not submerge the sprayer in cleaning fluid. Openings in shroud allow cooling of mechanical parts and electronics inside. If water or cleaning fluid gets into these openings, the sprayer could malfunction or become permanently damaged.

1. Engage trigger lock and pull prime/spray valve UP to release pressure.

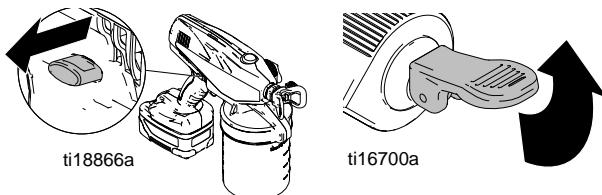

2. Remove material cup and return excess material to proper container. If used, properly dispose the material cup liner.
3. Remove flexible suction tube as shown below.

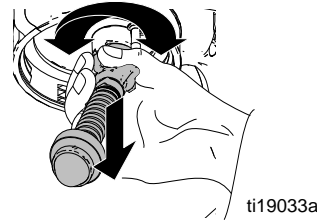

NOTICE

When removing flexible suction tube from sprayer, make sure to pull directly on top fitting of flexible suction tube. Flexible suction tube will become damaged if pulled from bottom or on flexible portion.

4. Use screwdriver to pry suction tube strainer from flexible suction tube.

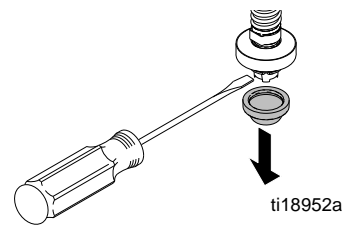

5. Clean flexible suction tube and suction tube strainer with water (or flushing fluid) and a brush every time you flush the sprayer. Reconnect flexible suction tube and suction tube strainer and orient as shown.

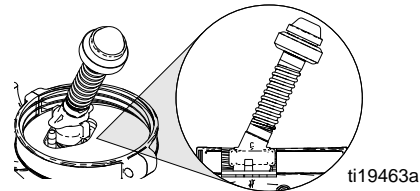
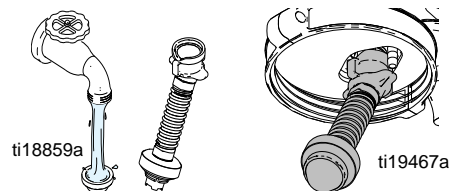

6. Clean material cup if not using a liner, and fill with water or appropriate flushing fluid.

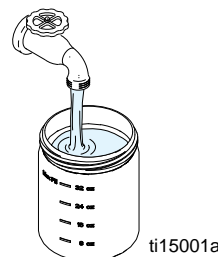

Shutdown and Cleaning

7. Reconnect material cup and shake sprayer to move clean water around and clean all areas inside of material cup.

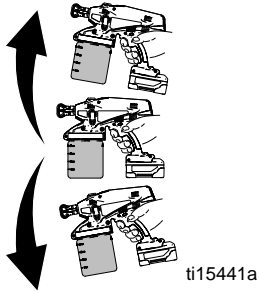

8. Disengage trigger lock and trigger sprayer for approximately 15 seconds. Engage trigger lock.

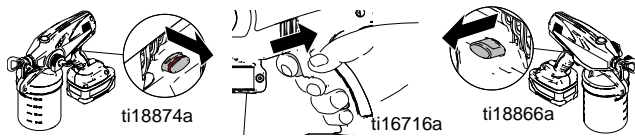

9. Discard contaminated fluid and refill with appropriate flushing fluid.

10. Disengage trigger lock, reverse Spray Tip to UNCLOG position, and pull trigger for 5 seconds to prime sprayer.

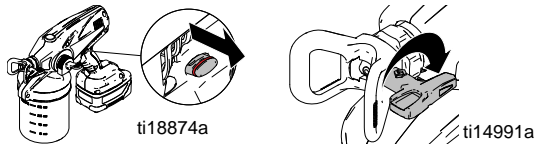

11. Put prime/spray valve DOWN to spray position. Trigger sprayer into waste area until no paint appears in water or flushing fluid.



12. Engage trigger lock and put prime/spray valve UP to release pressure.

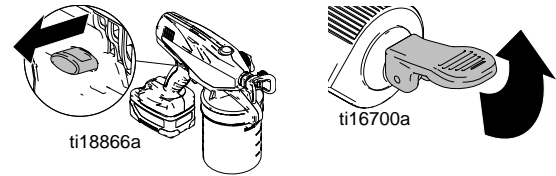

NOTE: Air vent holes or the air vent valve (as your model is equipped) allow air to flow into the material cup while spraying to prevent loss of fluid flow.

13. Remove material cup and discard used fluid.

Remove air vent valve, clean, and reinstall. If vent holes become clogged, use a paper clip to clear the holes.

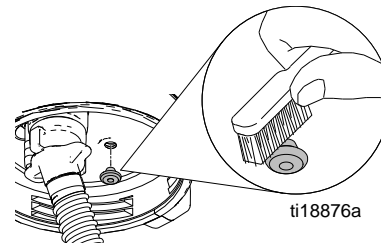
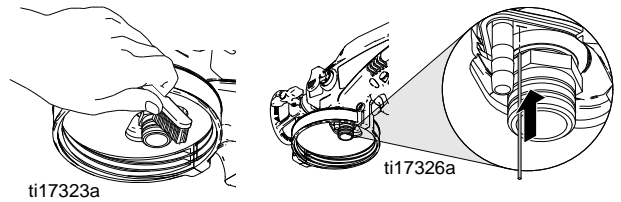

14. Remove spray/tip guard assembly and clean with water or flushing fluid. A soft brush can be used to loosen and remove dried material if needed.

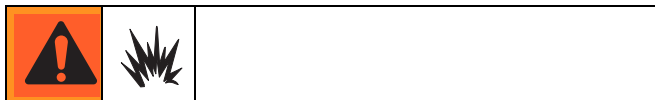
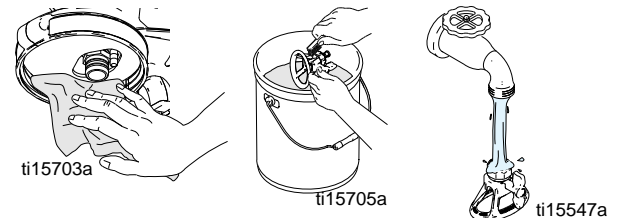

To avoid serious injury or damage to equipment, do not expose the sprayer electronics to flushing solvents. Keep sprayer **at least 10 in. (25 cm)** above the rim of the container when flushing.

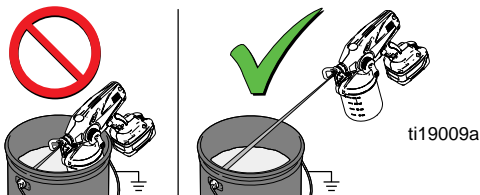

Keep spray area well-ventilated. Keep a good supply of fresh air moving through the area. When flushing with solvents, always ground the sprayer and waste container.

NOTICE

The spray tip is permanently attached to the guard. Removing the spray tip from the guard will result in damage to the spray tip assembly. Do not store spray/tip guard assembly or flexible suction tube in solvent other than mineral spirits. Damage to parts may occur.

Cleaning Sprayer Exterior

Wipe paint off outside of sprayer using a soft cloth moistened with water or flushing fluid. Use only water-based or oil-based (mineral spirit-type) materials with flash point greater than 100° F (38° C). Do NOT submerge the sprayer.



ti18879a

Storage



NOTICE

Failure to store sprayer with Pump Armor will result in operational problems the next time you spray. Always circulate Pump Armor through the sprayer after cleaning. **Water or solvents other than mineral spirits left in the sprayer will corrode and damage the pump.**

1. Lift prime/spray valve UP to the prime position. Remove material cup and flexible suction tube.

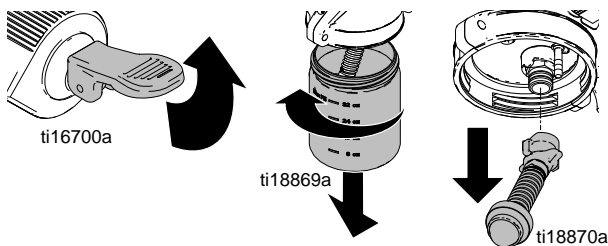

2. Remove child-resistant cap. Thread nozzle onto Pump Armor bottle. **NOTE:** For best results, make sure bottle is full.

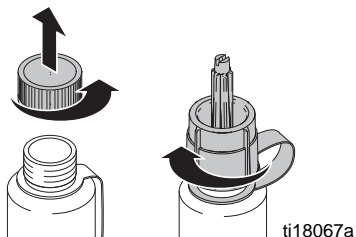

3. Hold sprayer upside-down over a waste container.

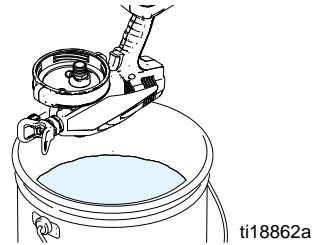

4. Insert Pump Armor nozzle over material inlet and push firmly until it stops. Squeeze cleaning bottle until Pump Armor flows out drain tube.

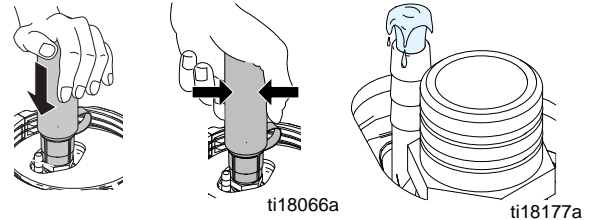

5. Remove Pump Armor nozzle and replace child-resistant cap and tighten securely for storage.

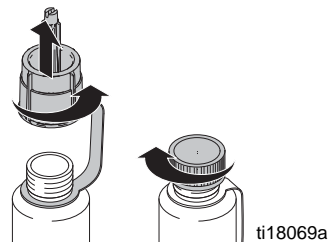

6. Attach flexible suction tube and material cup. Push valve DOWN to spray position.

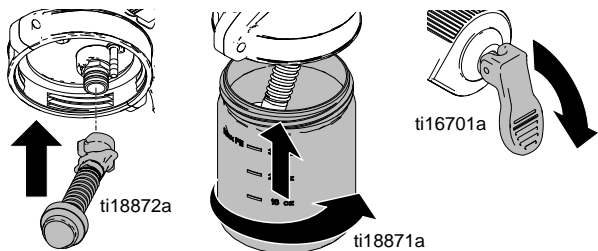

7. Recharge battery to full charge before storage. See **Charging the Battery**, page 6.

8. Store sprayer indoors in a cool, dry place. Store in an **upright position only**. Never store sprayer with material in the cup.

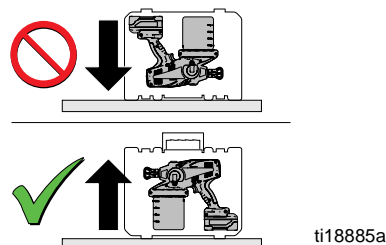

General Service

See manual 3A1884 (available at www.graco.com) for complete instructions on properly servicing your sprayer.

If you have opened the sprayer clamshell and do not have access to manual 3A1884, follow the instructions below to reduce the risk of errors when assembling the sprayer clamshell.

Wiring

Align switch in enclosure, install control board, and route wires as shown below. **NOTE:** Make sure wires will not be pinched when enclosure halves are put together.

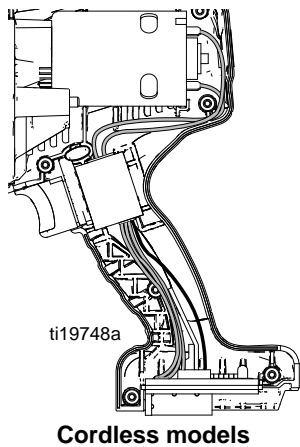

Pressure Control Knob

1. Use the pressure control knob as a tool to rotate retainer fully clockwise (there should be no gap between retainer teeth and metal valve housing).
NOTE: You may occasionally have to remove, rotate, and reposition pressure control knob due to stop feature molded into back of knob.
2. Rotate retainer back (counter-clockwise) until the first instance that the line and mark are aligned.
3. The valve retainer should now protrude approximately 1/8 in. (.30 cm) out from metal valve housing. Your prime/spray valve is now calibrated.

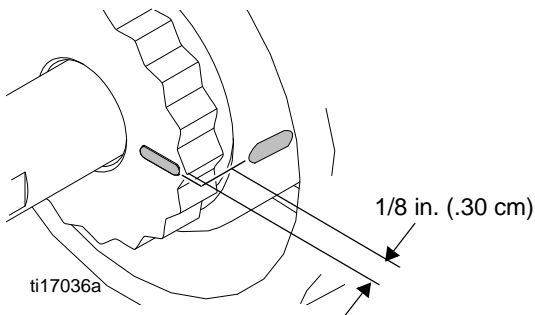

4. Position pressure control knob in fully clockwise position and press firmly onto retainer.

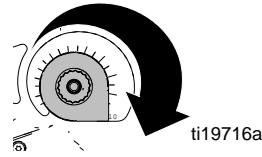

NOTE: You may have to rotate pressure control knob slightly counter-clockwise to fully engage pressure control knob with retainer.

5. Install washer onto pressure control knob.

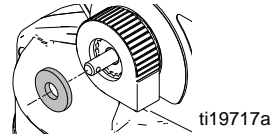

6. Install valve handle onto stem.

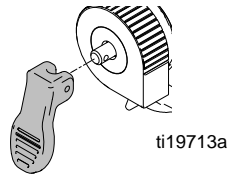

7. Insert pin into valve handle. Use pliers to press pin into hole.

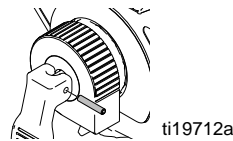

NOTE: If pin does not assemble, repeat steps 3 - 6 to ensure pressure control is fully engaged with retainer.

IMPORTANT!

After assembly is complete, perform the following steps to verify proper operation. If sprayer fails one of the steps, repeat **Pressure Control Knob** procedure.

- Verify proper trigger lock operation. Slide trigger lock into "locked" and "unlocked" position and pull trigger. Trigger should not move in locked position and sprayer should run in unlocked position.
- Visually inspect for gaps between enclosure halves. A gap larger than 1/32 in. could be caused by a pinched wire. If disassembly and inspection indicates that no wire has been pinched, carefully reassemble and repeat verification steps.
- **Cordless Sprayers:** Verify that battery freely slides onto sprayer terminals and is locked when fully engaged.
- Verify belt hook operation (if applicable) by sliding hook completely out and back inside.
- Fill material cup with water and verify unit primes and sprays. Follow setup instructions in sprayer operation manual for proper priming and spraying procedure.
- Rotate pressure control knob to make sure it can rotate fully in both directions.

Replacement Parts

Models 16M886, 16N657, 24R747

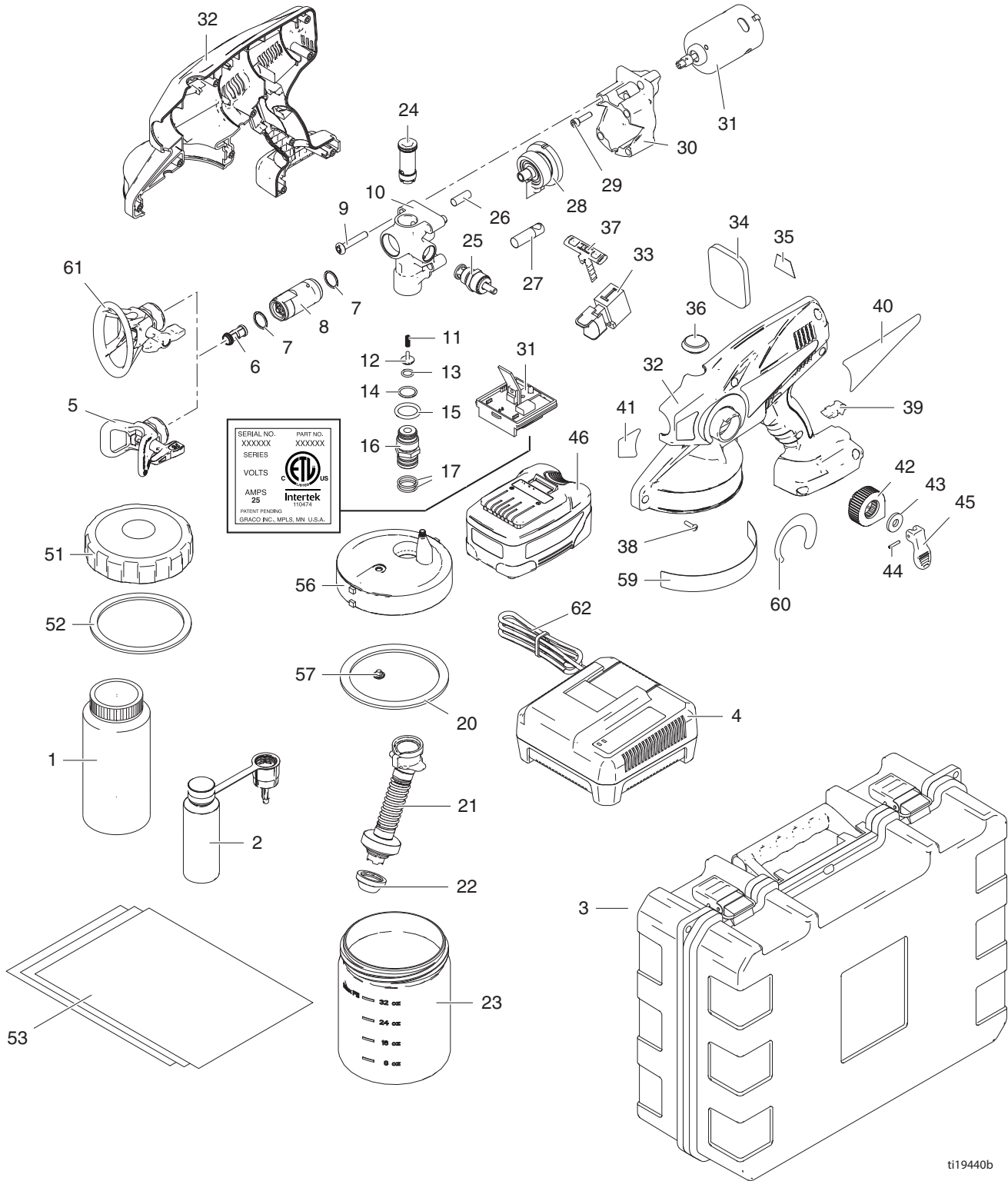

ti19440b

Parts List - Models 16N657, 16M886, 24R747

Ref.	If you have this model sprayer (model number is the same as the part number, which is between the battery and the sprayer)	Order Part Number:	Description
	Model 16N657, 24R747	262842	Sprayer Replacement Kit: includes parts 2, 7-20, 24-45, 56, 57, 59, 60
	Model 16M886	262843	Sprayer Replacement Kit: includes parts 2, 7-20, 24-45, 56, 57, 59, 60
1	All models	243103	Pump Armor (32 oz)
2	All models	16M816	Startup/Storage Kit
3	All models	16P458	Storage Case
4	All models	16D559	Battery Charger
5	Model 16M886	PST211	211 Spray Tip/Guard Assembly
	Model 16M886	PST213	213 Spray Tip/Guard Assembly
	Model 16M886	PST315	315 Spray Tip/Guard Assembly
	Model 16M886	PST411	411 Spray Tip/Guard Assembly
	Model 16M886	PST413	413 Spray Tip/Guard Assembly
	Model 16M886	PST515	515 Spray Tip/Guard Assembly
	Model 16M886	PST517	517 Spray Tip/Guard Assembly
6	All models	24E376	1 pack Spray Tip Filter
	All models	24F039	3 pack Spray Tip Filter
7	All models	108195	Needle Assembly O-ring
8	Model 16M886	262437	Needle Assembly Kit: includes parts 7 (qty. 2), 8
	Model 16N657, 24R747	262438	Needle Assembly Kit: includes parts 7 (qty. 2), 8
9	All models	115478	Screw
10	All models	16M865	Complete Pump Assembly w/Adjustable Prime/Spray Valve: includes parts 10, 11-17, 24-28, 44
	All models	16M868	Pump Housing Only: includes parts 10, 26, 27, 44
11	All models	262602	Inlet valve Repair Kit; includes 11, 12, 13
12	All models	262602	Inlet valve Repair Kit; includes 11, 12, 13
13	All models	262602	Inlet valve Repair Kit; includes 11, 12, 13
14	All models	109576	O-ring
15	All models	119790	O-ring
16	All models	16P151	Inlet/Outlet Valve Repair Kit: includes parts 11-17, 24
17	All models	106553	Suction Tube O-ring
20	All models	16J731	Sprayer Cup Seal
21	All models	16P121	Flexible Suction Tube Kit: includes parts 17 (qty. 2), 21, 22
22	All models	16N522	Flexible Suction Tube Strainer
23	All models	16D560	32 oz Material Cup: includes parts 23, 51, 52
		16D561	48 oz Material Cup: includes parts 23, 51, 52
24	All models	16P151	Inlet/Outlet Valve Repair Kit: includes parts 11-17, 24
25	All models	16M873	Adjustable Prime/Spray Valve Repair Kit: includes 25, 42-45
26	All models	16M865	Complete Pump Assembly w/Adjustable Prime/Spray Valve: includes parts 10, 11-17, 24-28, 44
	All models	16M868	Pump Housing Only: includes parts 10, 26, 27, 44
(Parts List continues on next page)			

Parts List - Models 16N657, 16M886, 24R747(Continued)

Ref.	If you have this model sprayer (model number is the same as the part number, which is between the battery and the sprayer)	Order Part Number:	Description
27	All models	16M865	Complete Pump Assembly w/Adjustable Prime/Spray Valve: includes parts 10, 11-17, 24-28, 44
	All models	16M868	Pump Housing Only: includes parts 10, 26, 27, 44
28	All models	16M863	Reciprocator Assembly Kit: includes parts 28, 44
29	All models	108326	Motor Mount Screw
30	All models	16M924	Drive Housing Assembly Kit: includes parts 9 (qty. 4), 29 (qty. 2), 30, 44
31	All models	16M861	Motor/Control Board Kit: includes parts 29, 31, 33, 34, 44
32	All models	16P461	Enclosure Replacement Kit: includes parts 32, 34-37, 38 (qty. 10), 39, 44, 55, 57
33	All models	16N928	Switch Kit: includes parts 33, 44
34	All models	16P461	Enclosure Replacement Kit: includes parts 32, 34-37, 38 (qty. 10), 39, 44, 55, 57
35	All models	16E859	Made in USA Label
36	All models	16C936	Outlet Valve Access Plug
37	All models	16M844	Lock, trigger w/ slide
38	All models	119236	Enclosure Screw
39	All models	16P461	Enclosure Replacement Kit: includes parts 32, 34-37, 38 (qty. 10), 39, 44, 55, 57
40	Model 16M886	16N556	Side Brand Label
	Model 16N657	17K655	Side Brand Label
	Model 24R747	16V496	Side Brand Label
41	All models	16R890	Front Brand Label
42	All models	16M873	Adjustable Prime/Spray Valve Repair Kit: includes parts 25, 42-45
43	All models	16M873	Adjustable Prime/Spray Valve Repair Kit: includes parts 25, 42-45
44	All models	119956	Pin
45	All models	262604	Prime Valve Handle: includes parts 44, 45
46	All models	17C930	Battery
51	All models	24D425	Material Cup Cover: includes parts 51, 52
52	All models	16C650	Seal for Material Cup
53	All models	16D562	Cup Liner Replacement (10 pack)
56	All models	16P461	Enclosure Replacement Kit: includes parts 32, 34-38, 39 (qty. 10), 44
57	All models	16M890	Air Vent Valve
59	All models	16R891	Cup Lip Brand Label
60	All models	16R889	Pressure Control Label
61	Model 16N657, 24R747	NAR311	311 Spray Tip/Guard Assembly
	Model 16N657, 24R747	NAR315	315 Spray Tip/Guard Assembly
	Model 16N657, 24R747	XWD515	515 Spray Tip/Guard Assembly
	Model 16N657, 24R747	XWD517	517 Spray Tip/Guard Assembly
62		16Y541	Power Cord, U.S
Not Shown		▲16P459	Warning Labels Replacement Kits ENG/FRE/SPA
▲ Replacement Danger and Warning labels, tags, and cards (Not Shown) are available at no cost.			

Inlet Valve Fitting Removal/Service

--	--	--	--	--

This equipment stays pressurized until pressure is manually relieved. To help prevent serious injury from pressurized fluid, such as skin injection, splashing fluid and moving parts, remove battery and follow the **Pressure Relief Procedure** when you stop spraying and before cleaning, checking, or servicing the equipment.

Move sprayer to a non-hazardous area before servicing.

1. Engage trigger lock and pull prime/spray valve UP to release pressure.

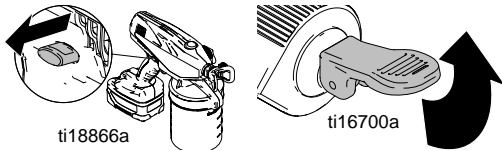

2. Remove material cup, flexible suction tube, and battery.

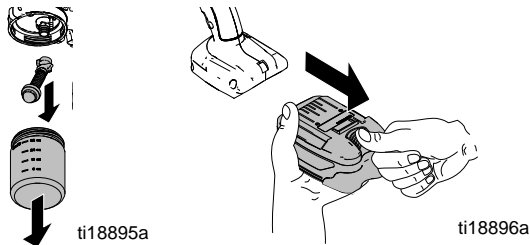

NOTICE

When removing flexible suction tube from sprayer, make sure to pull directly on top fitting of flexible suction tube. Flexible suction tube will become damaged if pulled from bottom or on flexible portion.

3. Hold sprayer upside-down and use wrench to loosen and remove inlet valve fitting, inlet valve, and spring.

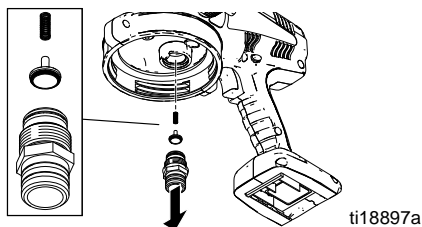

NOTE: Make sure the spring also comes out. Use needle-nose pliers to remove if needed. Inlet cavity should be completely empty (as shown below).

4. Clean as much excess material from inlet cavity as possible. Make sure you also clean spring (a), inlet valve (b), o-ring (c), and top of inlet valve fitting (d).

5. Use a thin wire less than 1/16 in. (such as a paper clip) to check that the outlet valve fitting moves freely. If valve does not move freely, perform **Outlet Valve Fitting Repair**, page 24.

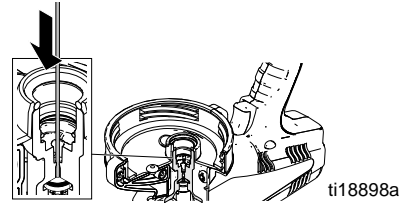

Installation

NOTE: Before installing, make sure o-ring (c) is installed on poppet valve (b). A needle-nose pliers can also be used to install parts (a - c).

1. Place poppet valve (b) with spring (a) on top of inlet valve fitting (d). Push inlet fitting up into pump cavity.

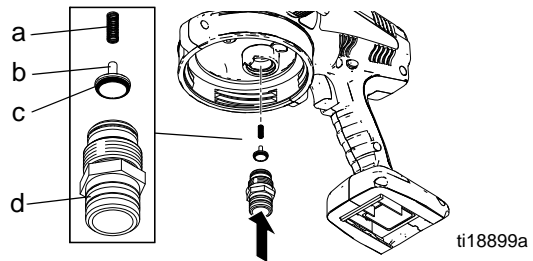

2. Hold inlet in place and turn sprayer upside-down. Remove inlet valve fitting and visually check to see that inlet valve has seated correctly.

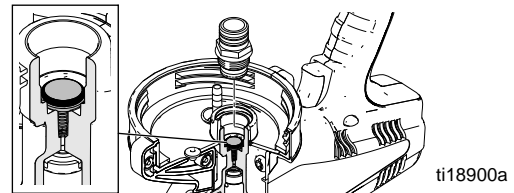

3. Replace inlet fitting and use wrench or socket to tighten to 10 ft-lb (14 N•m).

NOTICE

Do **NOT** over-tighten inlet valve fitting. Damage to the equipment will occur.

4. Use a pencil or thin rod to lightly push on inlet valve to make sure it moves up and down freely. Perform **Starting New Job** procedure, page 12.

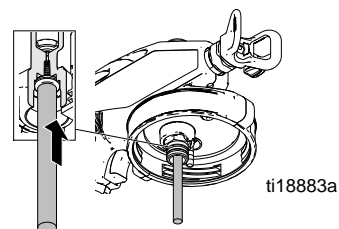

Outlet Valve Fitting Repair



This equipment stays pressurized until pressure is manually relieved. To help prevent serious injury from pressurized fluid, such as skin injection, splashing fluid and moving parts, remove battery and follow the **Pressure Relief Procedure** when you stop spraying and before cleaning, checking, or servicing the equipment.

Move sprayer to a non-hazardous area before servicing.

NOTE: Before doing any repair to pump, perform **Flushing Sprayer** procedure, page 16.

Removal

1. Engage trigger lock and pull prime/spray valve UP to release pressure.

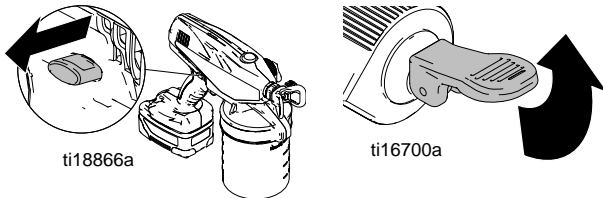

2. Remove battery.

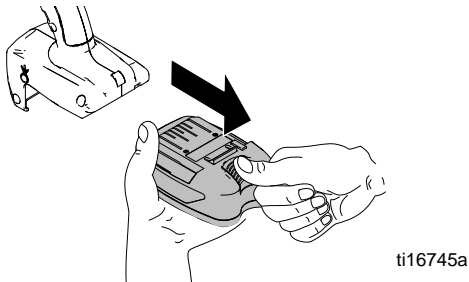

3. Remove outlet valve fitting access plug.

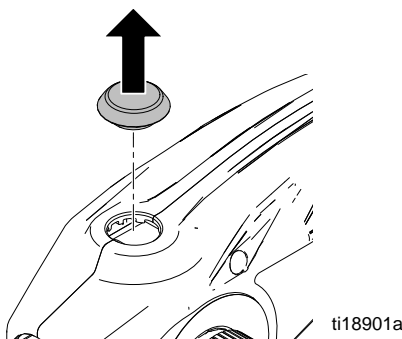

4. Use tool (supplied) to loosen and remove outlet valve fitting. Make sure old o-ring, seat, outlet valve fitting, and spring are out of pump outlet cavity.

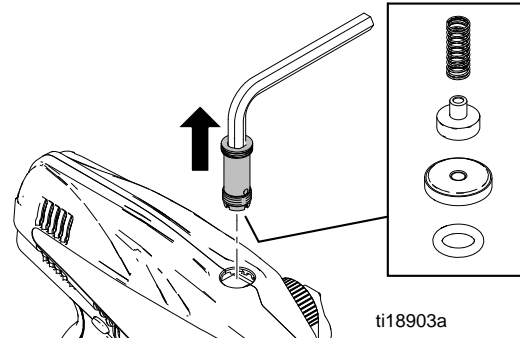

Installation

1. Screw outlet valve fitting into threads. Use tool (supplied) and tighten to 8 ft-lb (11 N•m).

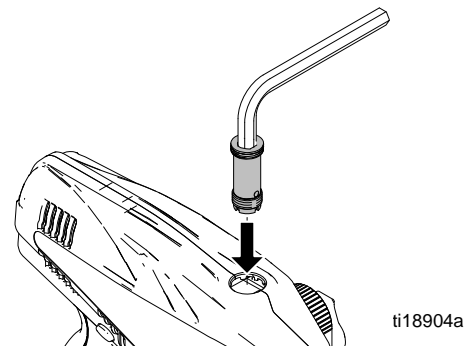

2. Press outlet valve fitting access plug into place.

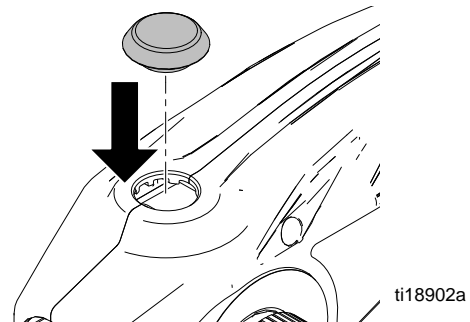

Troubleshooting



This equipment stays pressurized until pressure is manually relieved. To help prevent serious injury from pressurized fluid, such as skin injection, splashing fluid and moving parts, remove battery and follow the **Pressure Relief Procedure** when you stop spraying and before cleaning, checking, or servicing the equipment.

Check everything in this Troubleshooting Table before you bring the sprayer to an authorized service center.





Problem	Cause	Solution
Sprayer makes no sound when trigger is pulled	Trigger is locked.	Disengage trigger lock. See page 8.
	Sprayer status indicator light is solid RED when triggering, indicating that the battery charge is low, or the battery is too cold.	Replace with charged battery and place old battery in charger, or allow battery to warm up.
	Sprayer status indicator light is flashing RED when triggering, indicating that the battery is too hot to operate.	Allow battery to cool.
	Sprayer status indicator light does not light when sprayer is triggered. Battery is not installed or is damaged.	Install battery or replace.
	Motor/control board kit has reached maximum life.	Replace motor/control board kit.

Problem	Cause	Solution
Sprayer makes sound but no material is sprayed when trigger is pulled	Sprayer is not primed.	Prime the pump. See Starting a New Job (or Refilling the Material Cup) , page 12. Use pump access armor storage/startup tool to clear pump of debris. See Storage , page 18. Clean air vent holes or the air vent valve as your model is equipped. See Shutdown and Cleaning , page 16.
	Prime/spray valve is in UP position.	Put prime/spray valve DOWN to spray position.
	Flexible suction tube is missing or improperly installed.	Make sure Flexible Suction Tube is properly installed, page 10.
	Flexible suction tube strainer or air vent valve or vent holes are clogged.	See Shutdown and Cleaning , page 16.
	Flexible suction tube o-rings are damaged or missing.	Replace flexible suction tube o-rings.
	Flexible suction tube is damaged.	Replace flexible suction tube.
	Spray tip is not in SPRAY position.	Turn spray tip to SPRAY position.
	Spray tip is clogged.	See Unclogging Spray Tip/Guard Assembly , page 15.
	Spray tip filter is clogged.	Remove and clean Spray tip filter. See Unclogging Spray Tip/Guard Assembly , page 15.
	Pressure control knob is too low.	Turn pressure control knob up.
	Sprayer has been tilted too far and flexible suction tube has lost contact with material.	Make sure material cup is filled with material. Rotate flexible suction tube, page 10. Do not tilt the material cup too far. Prime the pump. See Starting a new Job (or Refilling the Material Cup) , page 12.
	No or low material in material cup.	Refill material cup with material and prime the pump.
	Inlet valve fitting is stuck from material residue left in sprayer.	Use pump access armor storage/startup tool to clear pump of debris. See Storage , page 18. If unsuccessful, see Inlet Valve Fitting Removal/Service , page 23.
	Pump is clogged, frozen, or has debris inside.	See Outlet Valve Fitting Repair , page 24 and Inlet Valve Fitting Removal/Service , page 23.
Material is leaking from hole in front of sprayer.	Replace needle assembly.	

Problem	Cause	Solution
Sprayer sprays with poor results	Spray tip is partially clogged.	See Unclogging Spray Tip/Guard Assembly , page 15.
	Spray tip is not in correct position.	Rotate spray tip to SPRAY position.
	Incorrect spray tip for application of material.	See Choosing the Correct Tip , page 13.
	Spray tip filter is partially clogged or damaged.	Clean or replace spray tip filter. See page 15.
	Flexible suction tube strainer is partially clogged.	Clean or replace flexible suction tube. See page 16.
	Spray tip is worn or damaged.	Replace spray tip. See Install Spray Tip/Guard Assembly , page 14.
	Material being sprayed is aerated because it was shaken.	Do NOT shake material. Stir the material or check the manufacturer's recommendation for the material being sprayed.
	Pressure control knob is too low.	Turn up pressure control knob.
	Material being sprayed is too cold to spray.	Warm material.
	Inlet or outlet valve fitting is worn.	See Outlet Valve Fitting Repair , page 24 and Inlet Valve Fitting Removal/Service , page 23.
	Pressure is set too high for thin material.	Turn pressure control knob down.
Paint leaks from sprayer trigger area.	Pump has reached its maximum life.	Replace pump.
Battery is discharged but charger still displays green light when battery is inserted.	Damaged battery.	Replace battery.
Battery does not last long.	Battery life varies with material, spray tip size, pressure, and speed setting.	See Battery and Charger , page 6.
Charger status indicator light remains solid red. Battery does not charge.	Hot charging environment or damaged battery.	See Battery and Charger , page 6. Unplug charger from outlet for 10 seconds to reset charger status indicator light. Attempt to charge again. If problem persists, move charger to cooler environment or replace battery.

Spray Pattern Diagnostics

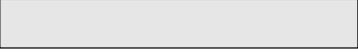
Problem	Cause	Solution
Spray pattern is pulsating: 	Operator is moving too fast while spraying.	Slow speed of movement.
	Spray tip or spray tip filter is clogged.	Unclog spray tip or clean spray tip filter, page 15.

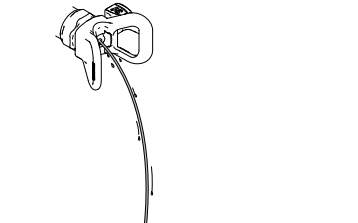
Problem	Cause	Solution
Spray pattern has tails:  ti15526a	Pressure control knob is too low. Incorrect spray tip for application of material. Material not compatible with sprayer. Inlet or outlet valve fitting is worn.	Turn up pressure control knob. See Choosing the Correct Tip , page 13. Switch to compatible material. See Outlet Valve Fitting Repair , page 24 and Inlet Valve Fitting Removal/Service , page 23.
Spray pattern has dripping: 	Sprayer is moving too slow for material. Sprayer is too close to target surface. Holding trigger while changing spray direction. Incorrect spray tip for application of material. Pressure control knob is set too high. Spray tip is worn or damaged.	Move sprayer faster while spraying. Move sprayer away from surface 10 in. (25 cm) Release trigger when changing directions. See Choosing the Correct Tip , page 13. Turn down pressure control knob. Replace spray tip. See Install Spray Tip/Guard Assembly , page 14.
Spray pattern is too narrow:  ti15523a	Sprayer is too close to target surface. Incorrect spray tip for application of material. Spray tip is worn or damaged.	Move sprayer away from surface 10 in. (25 cm) See Choosing the Correct Tip , page 13. Replace spray tip. See Install Spray Tip/Guard Assembly , page 14.
Spray pattern is too wide:  ti15527a	Sprayer is too far away from target surface. Incorrect spray tip for application of material.	Move sprayer closer to surface. See Choosing the Correct Tip , page 13.
Spray pattern "spits" at the end or beginning:  ti15525a	Excess material has accumulated on spray/tip guard assembly. Spray tip filter is partially clogged or damaged. Spray tip/guard assembly not threaded completely onto sprayer. Seat is worn.	See Shutdown and Cleaning , page 16. Clean or replace filter. See page 15. See Install Spray Tip/Guard Assembly , page 14. Replace spray tip/guard assembly.
Spray tip continues to drip or ooze material after trigger is released: 	Spray tip filter is partially clogged or damaged. Spray tip/guard assembly not threaded completely onto sprayer. Seat is worn. If the three solutions above do not solve the problem, replace needle assembly.	Clean or replace filter. See page 15. See Install Spray Tip/Guard Assembly , page 14. Replace spray tip/guard assembly.

Troubleshooting Leaks

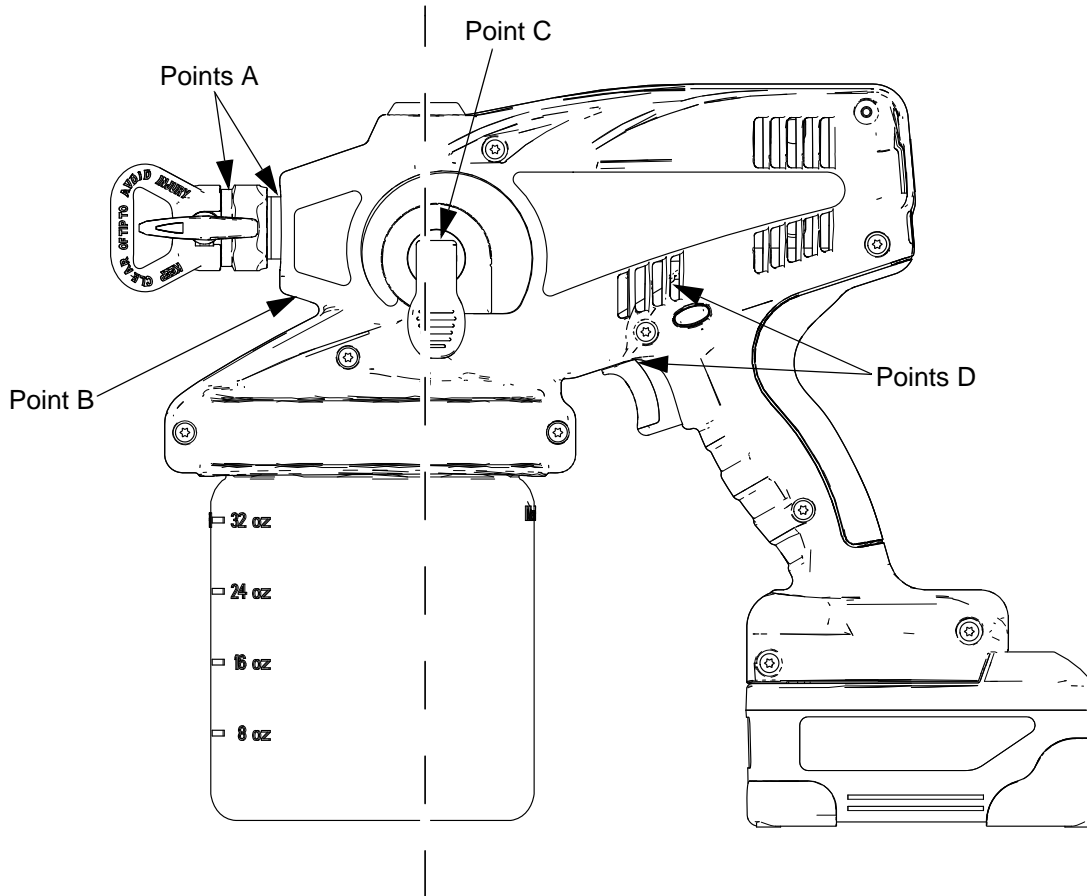

Problem	Cause	Solution
Sprayer is leaking fluid at Points A	Spray/tip guard assembly is loose.	Tighten spray/tip guard assembly.
	O-ring inside needle assembly is worn out.	Replace o-ring (108195).
Sprayer is leaking fluid at Point B	O-ring on rear of needle assembly is worn out.	Replace o-ring (108195).
	If 3 solutions above do not stop the leaking, replace needle assembly kit.	
Sprayer is leaking fluid at Point C	Prime/spray valve assembly is worn out.	Replace prime/spray valve assembly.
Sprayer is leaking fluid at Points D	Pump is worn out.	Replace bare or complete housing assembly.

Technical Data

Hand-Held Sprayer (Models 16N657, 16M886, 24R747)		
	U.S.	Metric
Adjustable pressure range	1000 - 2000 psi	7.0 - 14 MPa, 69 -138 bar
Maximum working pressure	2000 psi	14 MPa, 138 bar
Weight	6.06 lb	2.75 kg
Dimensions:		
Length	13.75 in.	34.9 cm
Width	5.25 in.	13.3 cm
Height	10.25 in.	26.0 cm
Storage temperature range ♦❖	32° to 113° F	0° to 45° C
Operating temperature range ✓	40° to 90° F	4° to 32° C
Storage humidity range	0% to 95% relative humidity, non-condensing	0% to 95% relative humidity, non-condensing
Sound pressure level	73.2 dBa† sound pressure level 84.2 dBa† sound power level	73.2 dBa† sound pressure level 84.2 dBa† sound power level
Vibration level acceleration	Less than 5.5 feet/s ² ††	Less than 1.7 m/s ² ††
Charger:		
Charging time	45 minutes to 80%, 75 minutes to 100%	45 minutes to 80%, 75 minutes to 100%
Power source	120 VAC	120 VAC
Battery (Lithium Ion):		
Voltage (DC)	20 V Maximum †††	20 V Maximum
Capacity (typical)	2.05 Ah, 36 Wh	2.05 Ah, 36 Wh

♦ Pump damage will occur if fluid freezes in pump.

❖ Damage to plastic parts may result if impact occurs in low temperature conditions.

✓ Changes in paint viscosity at very low or very high temperatures can affect sprayer performance.



† per ISO 9614-2 measured at 3.3 feet (1m)

†† per ISO 5349, no load condition

††† Maximum measured battery voltage is 20V. Average running voltage is 18V.

Preferred Material Settings Log

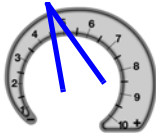
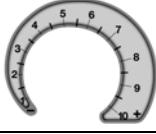
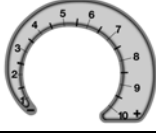
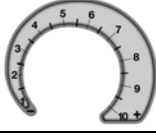
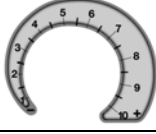
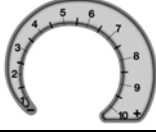
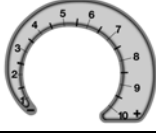
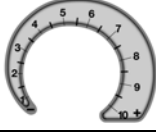
EXAMPLE

Date	Item Sprayed	Material Sprayed	Spray Tip	Pressure Setting (Mark Dial)
03/24/2011	Crown molding		PST515	
				
				
				
				
				
				
				
				

Graco Standard Warranty

Graco warrants all equipment referenced in this document which is manufactured by Graco and bearing its name to be free from defects in material and workmanship on the date of sale to the original purchaser for use. With the exception of any special, extended, or limited warranty published by Graco, Graco will, for a period of twelve months from the date of sale, repair or replace any part of the equipment determined by Graco to be defective. This warranty applies only when the equipment is installed, operated and maintained in accordance with Graco's written recommendations.

This warranty does not cover, and Graco shall not be liable for general wear and tear, or any malfunction, damage or wear caused by faulty installation, misapplication, abrasion, corrosion, inadequate or improper maintenance, negligence, accident, tampering, or substitution of non-Graco component parts. Nor shall Graco be liable for malfunction, damage or wear caused by the incompatibility of Graco equipment with structures, accessories, equipment or materials not supplied by Graco, or the improper design, manufacture, installation, operation or maintenance of structures, accessories, equipment or materials not supplied by Graco.

This warranty is conditioned upon the prepaid return of the equipment claimed to be defective to an authorized Graco distributor for verification of the claimed defect. If the claimed defect is verified, Graco will repair or replace free of charge any defective parts. The equipment will be returned to the original purchaser transportation prepaid. If inspection of the equipment does not disclose any defect in material or workmanship, repairs will be made at a reasonable charge, which charges may include the costs of parts, labor, and transportation.

THIS WARRANTY IS EXCLUSIVE, AND IS IN LIEU OF ANY OTHER WARRANTIES, EXPRESS OR IMPLIED, INCLUDING BUT NOT LIMITED TO WARRANTY OF MERCHANTABILITY OR WARRANTY OF FITNESS FOR A PARTICULAR PURPOSE.

Graco's sole obligation and buyer's sole remedy for any breach of warranty shall be as set forth above. The buyer agrees that no other remedy (including, but not limited to, incidental or consequential damages for lost profits, lost sales, injury to person or property, or any other incidental or consequential loss) shall be available. Any action for breach of warranty must be brought within two (2) years of the date of sale.

GRACO MAKES NO WARRANTY, AND DISCLAIMS ALL IMPLIED WARRANTIES OF MERCHANTABILITY AND FITNESS FOR A PARTICULAR PURPOSE, IN CONNECTION WITH ACCESSORIES, EQUIPMENT, MATERIALS OR COMPONENTS SOLD BUT NOT MANUFACTURED BY GRACO. These items sold, but not manufactured by Graco (such as electric motors, switches, hose, etc.), are subject to the warranty, if any, of their manufacturer. Graco will provide purchaser with reasonable assistance in making any claim for breach of these warranties.

In no event will Graco be liable for indirect, incidental, special or consequential damages resulting from Graco supplying equipment hereunder, or the furnishing, performance, or use of any products or other goods sold hereto, whether due to a breach of contract, breach of warranty, the negligence of Graco, or otherwise.

Graco Information

For the latest information about Graco products, visit www.graco.com.

For patent information, see www.graco.com/patents.

TO PLACE AN ORDER, contact your Graco distributor or call 1-800-690-2894 to identify the nearest distributor.

All written and visual data contained in this document reflects the latest product information available at the time of publication. Graco reserves the right to make changes at any time without notice.

For patent information, see www.graco.com/patents.

Original instructions. This manual contains English. MM 3A2589

Graco Headquarters: Minneapolis
International Offices: Belgium, China, Japan, Korea

GRACO INC. AND SUBSIDIARIES • P.O. BOX 1441 • MINNEAPOLIS MN 55440-1441 • USA

Copyright 2010, Graco Inc. All Graco manufacturing locations are registered to ISO 9001.

www.graco.com

Revised F, April 2016