

EvenFlow™ Roller Valve Assembly

309554B

Model: 246279

3000 psi (20.7 MPa, 207 bar) Maximum Fluid Inlet Pressure*

**The best operating pressure is the lowest pressure that provides an even paint supply to the roller and typically does not exceed 300 psi (2.1 MPa, 21 bar).*

Includes:



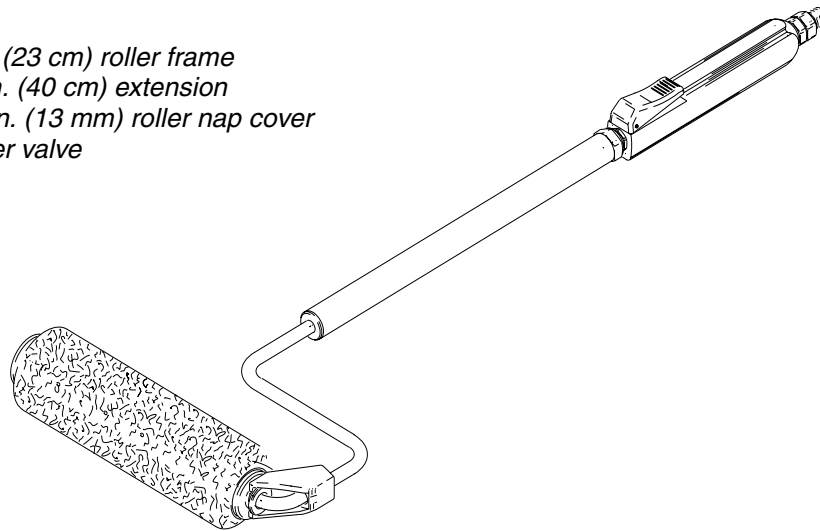

- 9 in. (23 cm) roller frame
- 16 in. (40 cm) extension
- 1/2 in. (13 mm) roller nap cover
- Roller valve



CAUTION

Never leave water in pressure roller frame, extension or roller valve. Doing so could cause corrosion and/or damage from freezing. For storage, flush components with Graco Pump Armor™ or mineral spirits/paint thinner.

PROVEN QUALITY. LEADING TECHNOLOGY.

 WARNINGS	
	<p>Fire, Explosion, and Electric Shock Hazard</p> <p>Improper grounding, poor air ventilation, open flames or sparks can cause a hazardous condition and result in fire, explosion and serious injury.</p> <ul style="list-style-type: none"> • Provide fresh air ventilation to avoid buildup of flammable fumes from flushing fluids or coatings being applied. • Keep application area free of debris, including solvent, rags, and gasoline.
	<p>Equipment Misuse Hazard</p> <p>Misuse can cause equipment to rupture or malfunction and cause serious injury.</p> <ul style="list-style-type: none"> • Read manuals, tags, and labels before operating equipment. • Use equipment only for its intended purpose. • Do not alter or modify extension tube, roller frame or use parts not designed for this equipment. • Do not use 1,1,1-trichloroethane, methylene chloride, other halogenated hydrocarbon solvents or fluids containing such solvents in this or any other pressurized aluminum equipment. Such use could result in a chemical reaction with the possibility of explosion.
	<p>Skin Injection Hazard</p> <p>High-pressure fluid from gun, hose leaks, or ruptured components will pierce skin. This may look like just a cut, but it is a serious injury that can result in amputation. Get immediate surgical treatment.</p> <ul style="list-style-type: none"> • Do not point gun at anyone or at any part of the body. • Do not put your hand over the spray tip. • Do not stop or deflect leaks with your hand, body, glove, or rag. • Engage trigger lock when not spraying. • Follow Pressure Relief Procedure in this manual, when you stop spraying and before cleaning, checking, or servicing equipment.
	<p>Electrocution Hazard</p> <p>Failure to observe the electrical hazards described below could result in serious injury, including burns or electrocution.</p> <ul style="list-style-type: none"> • Avoid contact with power lines. • Follow all grounding instructions in your separate sprayer instruction manual. • Comply with all local, state and national fire, electrical and safety regulations. • Only use Graco paint hoses.

Setup

1. Turn OFF sprayer power switch.

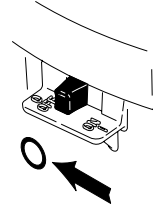

ti2011

2. Connect end of grounded fluid hose to inlet of roller valve. Use wrench to tighten.

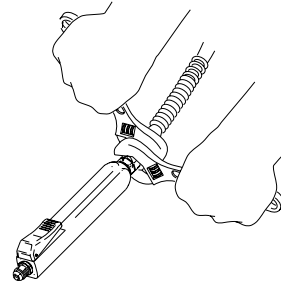

ti1978

3. Connect other end of hose to sprayer fluid outlet fitting. Use wrench to tighten.

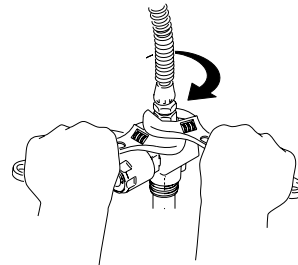

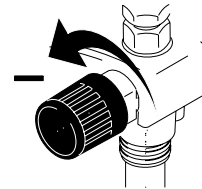

ti1979

4. Turn pressure control knob left (minimum pressure).



Priming

For loading pump and hose with paint.

 WARNING			
			page 2

1. Turn OFF sprayer power switch.

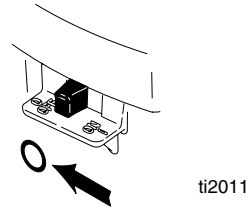

2. Place prime tube in waste pail. Submerge suction tube in paint.

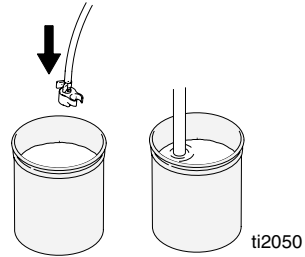

3. Turn Prime/Spray valve to PRIME.

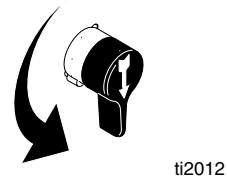

4. Point roller valve into waste pail.



5. Turn ON sprayer power switch. Align arrow on sprayer and pail symbol on pressure control knob.

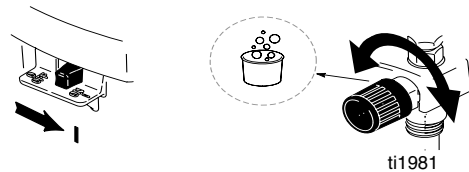

-
6. When paint, without bubbles, starts to come out of prime tube, trigger roller valve and turn Prime/Spray valve to SPRAY. When paint comes out of roller valve, release trigger.

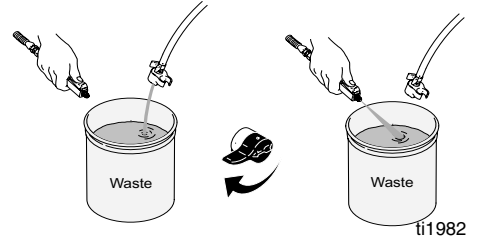

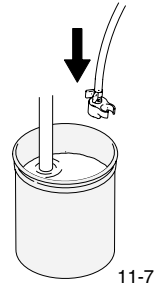

The motor stopping indicates the pump and hose are primed with paint.

-
7. Transfer prime tube to paint pail.



Roller Operation

 WARNING			
			page 2

1. Turn OFF sprayer power switch. Turn Prime/Spray valve to PRIME.

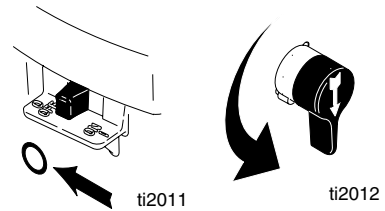

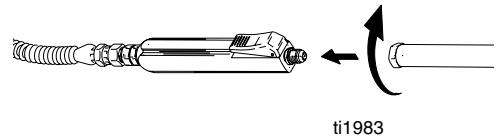

2. Rest roller frame and extension on flat surface and align roller valve with roller. Attach roller valve to pole making sure roller frame and valve are correctly aligned. Use a wrench to tighten.

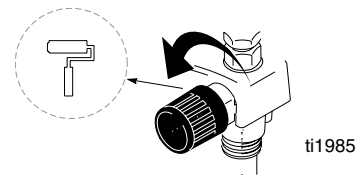

3. Align arrow on sprayer to roller symbol on pressure control knob.



Only minimum pressure is needed for rolling. Turn pressure control knob down as low as possible.

 WARNING			
			page 2

4. Turn ON sprayer power switch. When pump is fully primed, turn Prime/Spray valve to SPRAY.

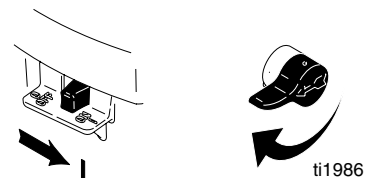

-
5. Trigger roller valve and roll surface until paint comes to roller and roller cover is uniformly wetted with paint.



Trigger roller valve briefly, only when you need more paint.

Only increase pump pressure if triggering gun does not supply enough paint for your rolling speed.

Whenever you stop painting, relieve pressure by following the **pressure relief procedure** described in your sprayer manual.

When you stop painting, elevate roller end of pole to prevent paint from draining out.

Rolling Techniques

Basic Techniques

1. Roll vertically, forming a letter "M".

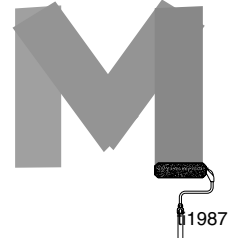

2. Cross roll, horizontally, to spread paint.

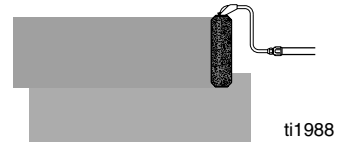

3. Finish with light, vertical strokes until entire area has been covered evenly.

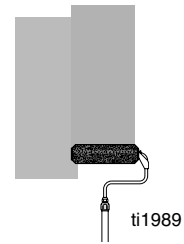

Ceilings

1. Where the walls meet the ceiling, use paint brush to apply starting row of paint the width of your brush.

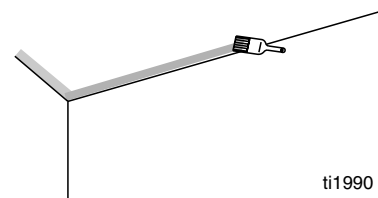

2. With roller, apply paint to ceiling, working the short way of the room. Apply as wide a strip as possible.

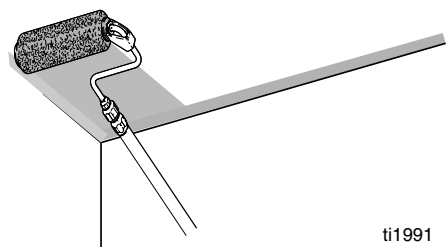

Woodwork & Walls

1. Using brush, paint woodwork first. Apply starting row of paint approximately the width of the paint brush around woodwork and where walls meet ceiling.

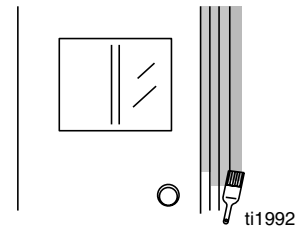

2. With roller, apply paint to walls, following rolling techniques (page 8).

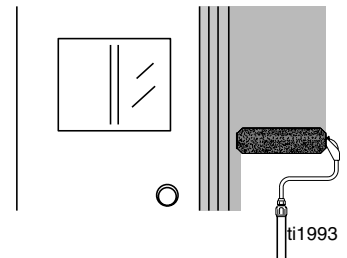

Cleanup



The roller assembly should remain attached to the roller valve for this procedure.

1. Relieve pressure by following the **pressure relief procedure** described in your sprayer manual.



ti2053

2. Turn OFF sprayer power switch.

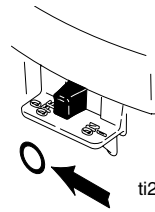

ti2011

3. Remove roller cover and diffuser from roller frame as follows:

- a. Using your thumb slide clip down and remove assembly from frame.
- b. Remove roller cover from diffuser.
- c. Pull end caps off diffuser.

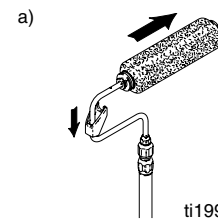

ti1999

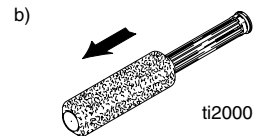

ti2000

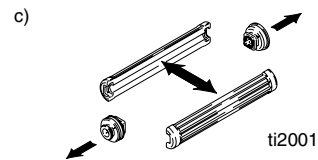

ti2001

4. Clean roller cover, caps and diffuser with water or compatible solvent.

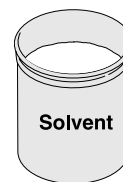

ti2016

-
5. Place roller frame in paint pail. Be sure holes in frame are facing inside paint pail.

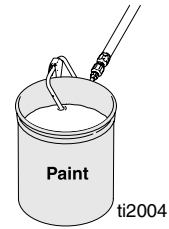

-
6. Place suction tube in pail of water or compatible solvent.

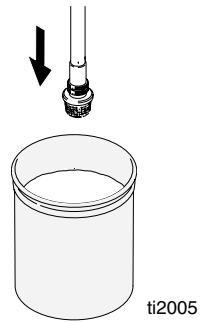

-
7. Align arrow on sprayer to roller symbol on pressure control knob.

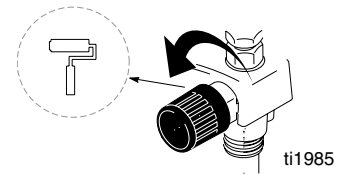

-
8. Turn ON sprayer power switch.

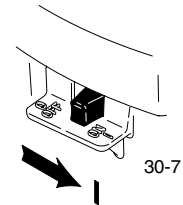

-
9. Turn Prime/Spray valve to PRIME.



-
10. Trigger roller valve.

 WARNING			
			page 2

-
- 11.** When pump is fully primed, turn Prime/Spray valve to SPRAY.



-
- 12.** Continue to trigger roller valve until flushing fluid begins to dilute paint. Then release trigger.

-
- 13.** Aim roller frame into waste pail. Continue to flush until fluid running out of roller frame is clear.

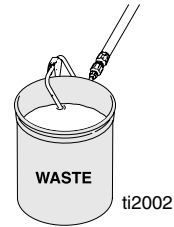

-
- 14.** Refer to your sprayer manual for additional cleanup information.

Parts

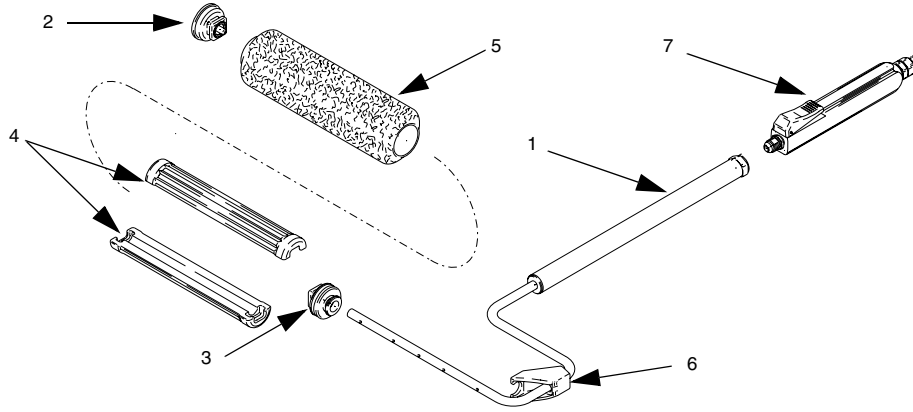

ti2087a

Item	Part No.	Description	Qty.
1	15A586	TUBE, extension	1
2	245999	CAP, end, roller	1
3	246277	CAP, end, roller	1
4	15B065	CORE, roller	2
5	107590	BRUSH, roller, 9 in. x 1/2 in. nap	1
6	197106	CLIP, roller	1
7	245590	Roller valve	1

Graco Standard Warranty

Graco warrants all equipment referenced in this document which is manufactured by Graco and bearing its name to be free from defects in material and workmanship on the date of sale by an authorized Graco distributor. With the exception of any special, extended, or limited warranty published by Graco, Graco will, for a period of twelve months from the date of sale, repair or replace any part of the equipment determined by Graco to be defective. This warranty applies only when the equipment is installed, operated and maintained in accordance with Graco's written recommendations.

This warranty does not cover, and Graco shall not be liable for general wear and tear, or any malfunction, damage or wear caused by faulty installation, misapplication, abrasion, corrosion, inadequate or improper maintenance, negligence, accident, tampering, or substitution of non-Graco component parts. Nor shall Graco be liable for malfunction, damage or wear caused by the incompatibility of Graco equipment with structures, accessories, equipment or materials not supplied by Graco, or the improper design, manufacture, installation, operation or maintenance of structures, accessories, equipment or materials not supplied by Graco.

This warranty is conditioned upon the prepaid return of the equipment claimed to be defective to an authorized Graco distributor for verification of the claimed defect. If the claimed defect is verified, Graco will repair or replace free of charge any defective parts. The equipment will be returned to the original purchaser transportation prepaid. If inspection of the equipment does not disclose any defect in material or workmanship, repairs will be made at a reasonable charge, which charges may include the costs of parts, labor, and transportation.

THIS WARRANTY IS EXCLUSIVE, AND IS IN LIEU OF ANY OTHER WARRANTIES, EXPRESS OR IMPLIED, INCLUDING BUT NOT LIMITED TO WARRANTY OF MERCHANTABILITY OR WARRANTY OF FITNESS FOR A PARTICULAR PURPOSE.

Graco's sole obligation and buyer's sole remedy for any breach of warranty shall be as set forth above. The buyer agrees that no other remedy (including, but not limited to, incidental or consequential damages for lost profits, lost sales, injury to person or property, or any other incidental or consequential loss) shall be available. Any action for breach of warranty must be brought within two (2) years of the date of sale.

GRACO MAKES NO WARRANTY, AND DISCLAIMS ALL IMPLIED WARRANTIES OF MERCHANTABILITY AND FITNESS FOR A PARTICULAR PURPOSE, IN CONNECTION WITH ACCESSORIES, EQUIPMENT, MATERIALS OR COMPONENTS SOLD BUT NOT MANUFACTURED BY GRACO. These items sold, but not manufactured by Graco (such as electric motors, switches, hose, etc.), are subject to the warranty, if any, of their manufacturer. Graco will provide purchaser with reasonable assistance in making any claim for breach of these warranties.

In no event will Graco be liable for indirect, incidental, special or consequential damages resulting from Graco supplying equipment hereunder, or the furnishing, performance, or use of any products or other goods sold hereto, whether due to a breach of contract, breach of warranty, the negligence of Graco, or otherwise.

FOR GRACO CANADA CUSTOMERS

The Parties acknowledge that they have required that the present document, as well as all documents, notices and legal proceedings entered into, given or instituted pursuant hereto or relating directly or indirectly hereto, be drawn up in English. Les parties reconnaissent avoir convenu que la rédaction du présente document sera en Anglais, ainsi que tous documents, avis et procédures judiciaires exécutés, donnés ou intentés, à la suite de ou en rapport, directement ou indirectement, avec les procédures concernées. All written and visual data contained in this document reflects the latest product information available at the time of publication. Graco reserves the right to make changes at any time without notice.

TO PLACE AN ORDER OR FOR SERVICE, contact your Graco distributor,
or call 1-800-690-2894 to identify the nearest distributor.

All written and visual data contained in this document reflects the latest product information available at the time of publication.
Graco reserves the right to make changes at any time without notice.

Sales Offices: Minneapolis, Detroit
International Offices: Belgium, Korea, Hong Kong, Japan

Graco Inc.
PO Box 1441 Minneapolis, MN 55440-1441
www. graco.com

309554 03/2007