

# Operation



## Interior Texture Sprayer TX 65

311763B  
EN

### *For Water-Based Materials Only*

#### **Model 254970:**

*50 psi (3.5 bar) Maximum Fluid Working Pressure  
100 psi (7 bar) Maximum Air Input Pressure*



#### **Important Safety Instructions**

Read all warnings and instructions in this manual.  
Save these instructions.

#### **Related Manuals:**



311769



311763

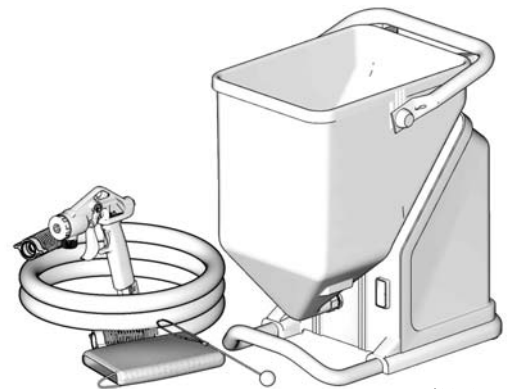

ti8370a



**Model 254970 Shown**







PROVEN QUALITY. LEADING TECHNOLOGY.



# Warnings

The following are general warnings related to the setup, use, grounding, maintenance and repair of this equipment. Additional, more specific warnings may be found throughout the body of this manual where applicable. Symbols appearing in the body of the manual refer to these general warnings. When these symbols appear through the manual, refer back to these pages for a description of the specific hazard.

	<b>Warnings</b>
	<p><b>Fire and Explosion Hazard</b> Improper grounding, poor ventilation, open flames or sparks can cause a hazardous condition and result in fire or explosion and serious injury.</p> <ul style="list-style-type: none"> <li>• The system is for use with water-based materials only. Only use fluids compatible with the equipment. Refer to Technical Data of all equipment manuals. Read fluid and solvent manufacturers warnings.</li> <li>• Ground the equipment. See <b>Grounding and Electrical Requirements</b>, page 6.</li> <li>• If there is any static sparking or you feel an electric shock while using this equipment, stop spraying immediately. Do not use the equipment until you identify and correct the problem.</li> <li>• Keep work area free of debris, including solvent, rags and gasoline.</li> <li>• Comply with all applicable state and national fire, electrical and safety regulations.</li> </ul>
	<p><b>Equipment Misuse Hazard</b> Equipment misuse can cause equipment to rupture, malfunction, or start unexpectedly and cause serious injury.</p> <ul style="list-style-type: none"> <li>• Before operating this equipment, read all manuals, tags, and labels including material labels and instructions.</li> <li>• Do not expose system to rain. Always store system indoors.</li> <li>• Do not alter or modify equipment.</li> <li>• Do not spray cementitious materials.</li> <li>• Do not exceed maximum working pressure of lowest rated component in your system.</li> <li>• Check equipment daily. Repair or replace worn or damaged parts immediately.</li> <li>• To reduce risk of serious injury, including electric shock and splashing fluid in eyes, follow <b>Pressure Relief Procedure</b> on page 6 before servicing the unit.</li> <li>• Do not use hoses to pull equipment.</li> <li>• Route hoses away from traffic areas, sharp edges, moving parts and hot surfaces.</li> <li>• Do not expose Graco hoses to temperatures above 130° F (55° C) or below -35° F (-37° C). Store hazardous fluid in an approved container. Dispose of hazardous fluid according to all local, state and national guidelines.</li> <li>• Never directly inhale compressed air. Compressed air may contain toxic vapors.</li> </ul>

	<p><b>Warnings</b></p>
 	<p><b>Electric Shock Hazard</b></p> <p>To reduce the risk of electric shock:</p> <ul style="list-style-type: none"> <li>• Be sure sprayer is adequately grounded through electrical outlet.</li> <li>• Use only 3-wire, extension cords.</li> <li>• Make sure ground prongs are intact on sprayer and extension cords. Improper installation of grounding plug will result in a risk of electrical shock, fire or explosion that could cause serious injury or death.</li> <li>• Do not operate with cover removed.</li> <li>• Turn off sprayer. Follow <b>Pressure Relief Procedure, page 6</b>, and unplug unit, before removing any parts.</li> </ul>
 	<p><b>Pressurized Equipment Hazard</b></p> <p>Fluid from gun, leaks or ruptured components can splash in the eyes or on skin and cause serious injury.</p> <ul style="list-style-type: none"> <li>• Follow <b>Pressure Relief Procedure, page 6</b> when you stop spraying and before cleaning, checking or servicing.</li> <li>• Do not point spray gun at anyone; put hand, fingers or rag over nozzle, or stop or deflect leaks with your hand, body, glove, or rag.</li> <li>• Wear protective clothing, gloves, and eyewear.</li> </ul>
	<p><b>Cleaning Solvent Hazard with Plastic Parts</b></p> <p>Use only compatible water-based solvents to clean plastic structural or pressure-containing parts. Many solvents can degrade plastic parts to the point where they could fail. Such failure could cause serious injury or property damage. See Technical Data on page 14 of this instruction manual and in all other equipment manuals. Read fluid and solvent manufacturer's warnings.</p>
	<p><b>Personal Protective Equipment</b></p> <p>You must wear appropriate protective equipment when operating, servicing, or when in the operating area of the equipment to help protect you from serious injury, including eye injury, inhalation of toxic fumes, burns, and hearing loss. This equipment includes but is not limited to:</p> <ul style="list-style-type: none"> <li>• Protective eyewear</li> <li>• Clothing and respirator as recommended by the fluid and solvent manufacturer</li> <li>• Gloves</li> <li>• Hearing Protection</li> </ul>

**CAUTION**

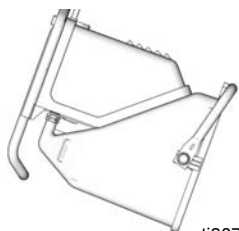

ti9075z

Water or material remaining in unit when temperatures are below freezing can damage motor and/or delay pump startup.

To insure water and material are completely drained out of unit:

1. Remove material line from sprayer.
2. Tip sprayer up as shown.

Before adding material or starting unit in cold weather, run warm water through pump.

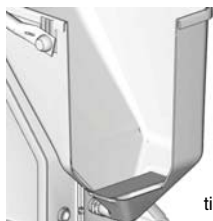

ti8376a

Before adding material to hopper, install burp guard. When only a small amount of material remains in the hopper, the burp guard prevents material from shooting out when the unit is turned off. This material could splash in the operator's eyes or on skin, or into the air.

# Component Identification

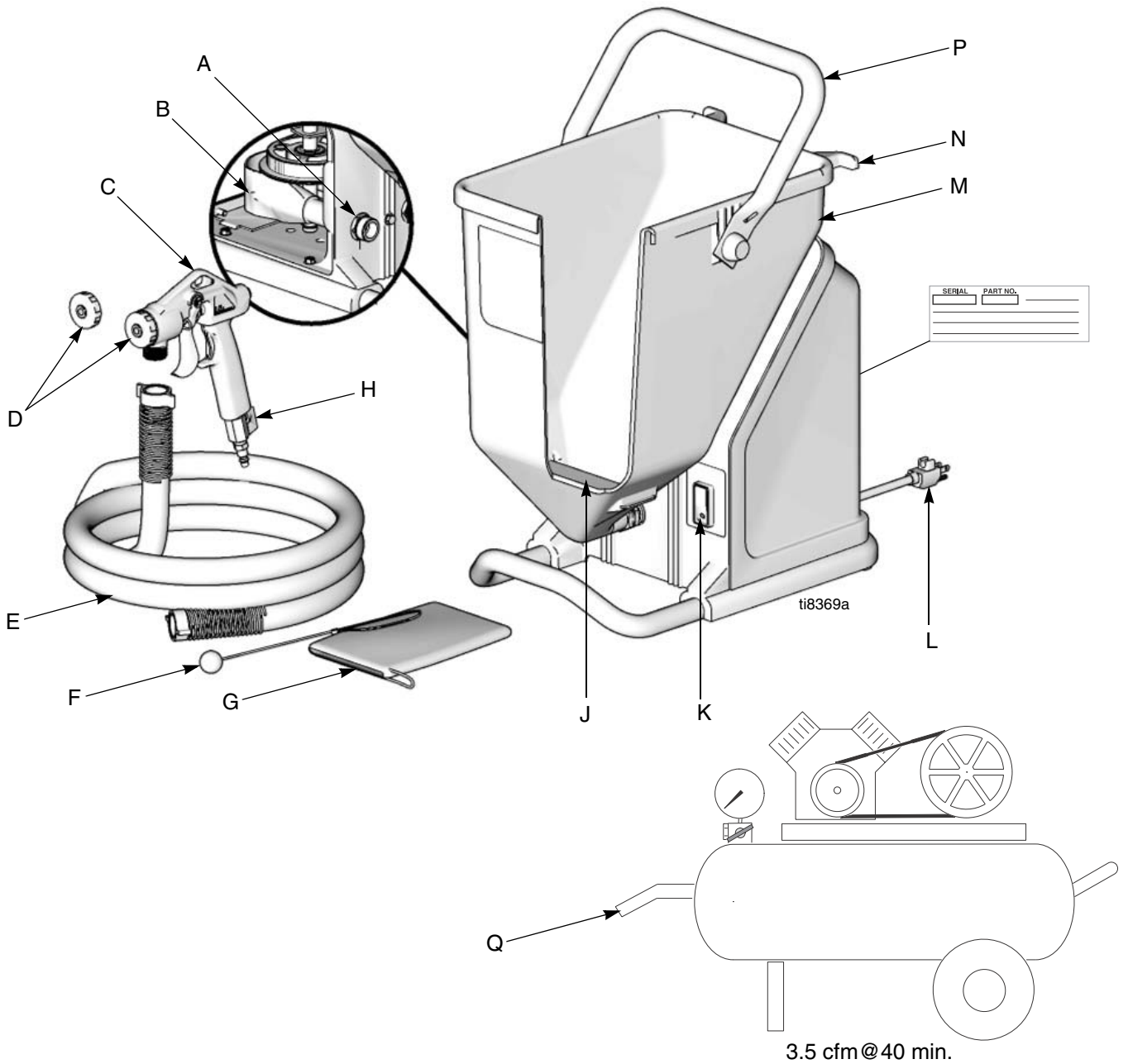

Item	Component	Item	Component
A	Pump Hose Outlet	H	Gun Air Valve
B	RotoFlex™ II Pump (inside)	J	Burp Guard
C	Texture Spray Gun (Manual 311777)	K	ON/OFF Switch
D	Nozzle (2 included, see <b>Nozzle Selection</b> , page 10)	L	Power Cord (120V, 15 ft)
E	Material Hose (20 ft)	M	Material Hopper - 5 gallon
F	Material Thickness Gauge	N	Cord Wrap
G	Accessories Bag	P	Handle
		Q	Air Compressor (Not Supplied by Graco)

# Preparation

## Pressure Relief Procedure

To reduce risk of injury, follow this procedure whenever you see this symbol throughout this manual, Also, perform this procedure whenever you:



- Stop spraying
- Check or repair any part of this system
- Install or clean spray nozzle



1. Turn power switch (K) OFF.

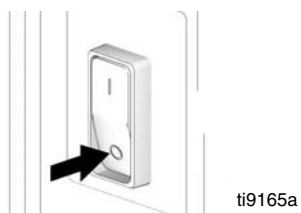

2. Trigger gun into material hopper.



3. Open gun air valve.

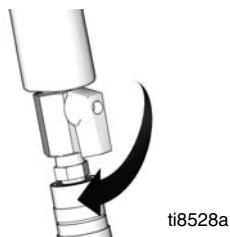

## Grounding and Electrical Requirements

This sprayer must be grounded. Grounding reduces the risk of electrical shock by providing an escape wire for the electrical current. The sprayer cord includes a grounding wire with an appropriate grounding plug. The plug must be plugged into an outlet that is properly installed and grounded in accordance with all local codes and ordinances.

Check with a qualified electrician or serviceman if grounding instructions are not completely understood, or if in doubt as to whether the product is properly grounded. Do not modify plug provided; if it will not fit the outlet, have proper outlet installed by a qualified electrician.



## 120V AC Systems

- This equipment requires a 120V AC, 60 Hz, 15A circuit with a grounding receptacle. Do not use an adapter with this product.

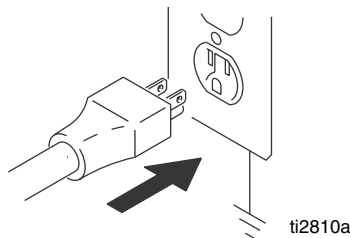

## Extension Cords

- Use only an extension cord with an undamaged, 3-prong plug.
- For 25 to 50 ft (7.6 to 15.2 m) cords, use 3-wire, 14 AWG (1.5 mm<sup>2</sup>) minimum.
- For up to 100 ft. (30.48 m) cord, use 3-wire, 12 AWG (2.5 mm<sup>2</sup>) minimum.

## Additional Required Equipment

### Auxiliary Air Compressor

Minimum Requirements: 3.5 CFM @ 40 psi or 2.5 CFM @ 90 psi (maximum 100 psi)

3/8 x 25 ft minimum airline rated @ 120 psi/min

### Alternate Power - Generator Requirements

3500 W (3.5 kW) minimum

# Setup

## Important

- To increase pump life, turn power off when not spraying.
- Do not allow material to dry inside pump, hoses, gun or spray system.
- To break in new pump run sprayer dry for no more than 2 minutes.

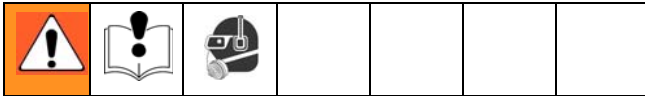

## Texture Spraying

1. Connect air hose to user-supplied air compressor & material hose (G) to material hose outlets.

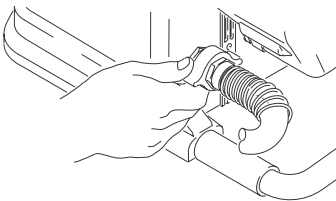

ti8375a

2. Connect air hose to gun.



ti8534a

3. Open air valve.



ti8528a

4. Connect material hose to gun.

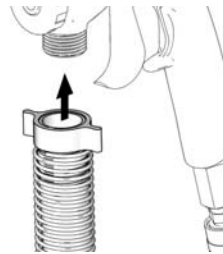

ti8705a

5. Install spray nozzle. See **Recommended Nozzle Selection Chart**, page 10.

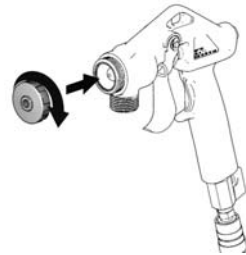

ti9774a

 To break in new pump run sprayer dry for no more than 2 minutes.

6. Fill material hopper with 1 gallon of water.

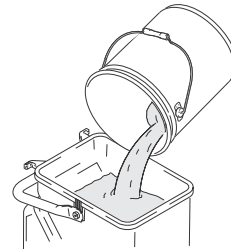

ti8372a

7. Turn power switch (K) ON (leave compressor OFF).



ti9202a

8. Point gun into waste bucket and pull trigger to pump water through the system. Continue to trigger gun until material hopper is empty.

9. Install burp guard (J). **Caution**, page 3.

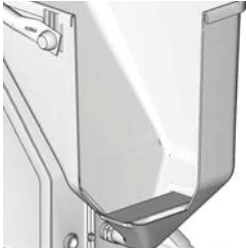

ti8376a

10. Add pre-mixed texture mix to material hopper. See Mixing Material, page 9.

11. Continue to trigger gun and spray into waste bucket until a steady stream of material sprays out of gun.

12. Turn on Air compressor and open gun valve to desired setting.

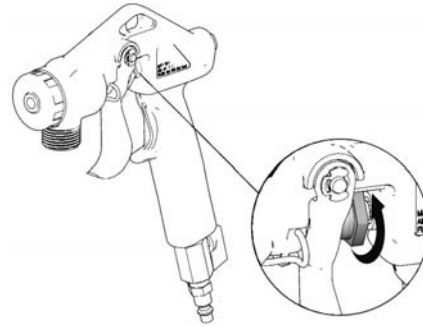

ti9775a

13. To achieve uniform spray pattern, adjust air valve and flow adjustment nut on gun. If you can not achieve a desired pattern, change nozzle, page 10.



Fluid flow will be restricted if the material hose is kinked.



# Mixing Material



Correct material mixture is essential. The pump will not operate if the mixture is too thick.

Mix the material in a separate container before pouring it into hopper.

Use Material Thickness Gauge to determine mixture is thin enough to spray.

\*The Material Thickness Gauge will only determine if the material is thin enough to pass through the pump. For some applications or for higher speed spraying, your mixture may need to be thinner.

## Dry Mix - 40 lb (18 kg) bag.



For best results do not use partial bags of material.

1. Slowly add one 40 lb. (18 kg) bag of texture material to 5-6 gallons (18.9-22.7 liters) of clean water as instructed on the bag instructions.



2. Agitate to mix, using a half-inch, variable speed drill with mixing paddle, to a smooth, lump-free consistency.



3. Allow ceiling texture to set for at least 15 minutes. Then remix prior to use.

4. After texture material is thoroughly mixed, gently set ball end of Material Thickness Gauge on surface of mixture.



For an accurate test, be sure gauge is completely dry and clean every time it is used.

5. Observe the ball on the material. When the material is thin enough to spray the ball will sink completely into the mixture.

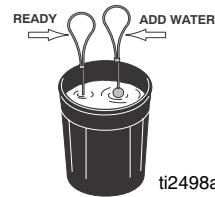

6. If the ball does not sink completely into the mixture within 10 seconds, add more water, agitate and try test again.

## Premix

1. Slowly add approximately 2 to 4 qts (1.9 to 3.8 liters) of water to a 5 gallon (18.9 liter) bucket of premix.

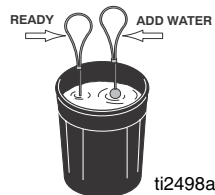

2. Agitate to mix, using a half-inch, variable speed drill with a mixing paddle, to a smooth, lump-free consistency.
3. After texture material is thoroughly mixed, gently set ball end of Material Thickness Gauge on surface of mixture.



For an accurate test, be sure gauge is completely dry and clean every time it is used.

4. Observe the ball in material. When the material is thin enough to spray the ball will sink completely into the mixture.
5. If the ball does not sink completely into the mixture within 10 seconds, add more water, agitate and try test again.

# Spray Techniques

## Recommended Nozzle Selection Chart

Application	Nozzle Size <sup>2</sup>	Air Volume <sup>1</sup>
Simulated Acoustic	6 mm, white <i>(fine to medium)</i> 8 mm, gray <i>(coarse)</i>	medium to high
Orange peel	6 mm, white	medium to high
Splatter coat	6 mm, white 8 mm, gray	low to medium
Knockdown	8 mm, gray	low

<sup>1</sup>Control air volume with gun air valve.

<sup>2</sup>For more material volume try a larger nozzle.

## Adjusting the System

Sufficient fluid output (volume and pressure) and good atomization is a balance of atomizing air, material thickness/material flow and nozzle selection. Achieving the correct balance for your application requires experimentation to achieve desired results. Keep in mind these important points when adjusting gun:

- Select proper nozzle for your application. See Nozzle Selection Chart. Remember, the larger the nozzle, the heavier the pattern.
- Start sprayer with gun air flow valve completely open. If needed, slowly close gun air flow until you get a good spray pattern. Use minimum amount of air at spray gun to achieve proper spray pattern and to minimize bounce back.
  - + Test spray pattern on cardboard. Hold gun 18 to 24 in. (45.7 to 60.9 cm) from surface. Use this spraying distance for most applications.
- Air and material flow adjustments are made at the gun on all units.
  - + Opening air valve increases air flow through gun, which decreases texture material flow through pump.
  - + Closing air valve decreases air flow through gun, which increases texture material flow through pump.

- Set air compression at a minimum of 25 psi. Additional air pressure may be needed for thicker materials or when product is applied to ceilings.

## To Get Less Material

Try one or a combination of these methods:

- Open air valve.
- Turn gun flow adjustment nut to decrease flow, counter-clockwise.
- Use smaller nozzle.

## To Get More Material

Try any one or a combination of these methods:

- Close air valve.
- Turn gun flow adjustment nut to increase flow, clockwise.
- Use thinner material mixture.
- Use a larger nozzle.

## Preventing Material Surge at Gun Trigger

Pressure will build up in the system when you stop triggering the gun. To prevent material surge at initial gun triggering:

- Point gun away from surface you are spraying when you first pull trigger.
- When you first start to spray, hold the gun away from the surface and gradually work your way closer to it.
- Keep gun moving.
- After you begin spraying, trigger the gun as little as possible.

## For Continuous Spraying

Use trigger lock to hold trigger open and reduce fatigue.

## Check Material Consistency Periodically

Check and thin material as needed to maintain proper consistency. The material may thicken as it sits and slow down production. Agitate periodically.

# Shutdown and Cleanup

 Keep pump and hose clean when switching between simulated acoustic, knockdown and orange peel applications. A dirty pump can release particles of texture into the finish.

CAUTION	
<ul style="list-style-type: none"><li>• To increase pump life, turn power off when not spraying.</li><li>• Before removing material hose be sure pressure is relieved and material is not in hose.</li><li>• To keep unit in good operating condition, always clean it thoroughly and prepare it properly for storage.</li></ul>	

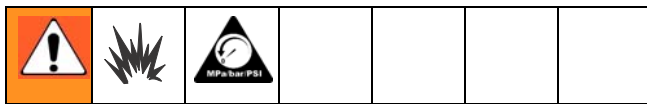

## Texture Spraying (5 gallon Material Hopper)

When you have finished spraying:

1. Turn sprayer power switch (K) ON (air compressor can remain OFF).

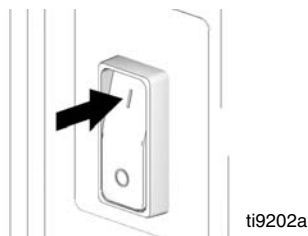

2. Close gun air valve.

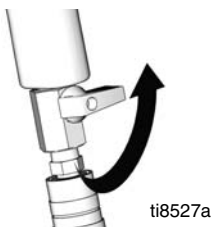

3. Trigger gun into bucket until most of texture mix is pumped out.
4. Fill material hopper with 2-4 gallons of clean water.

5. Spray inside material hopper to circulate water through gun and hose. While circulating water, use gun to clean material hopper.

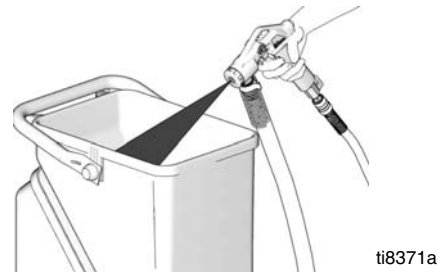

6. Spray water into a waste bucket to empty material hopper.

 A soft brush can be used to loosen dried on material.

7. Turn sprayer power switch OFF.
8. Turn air compressor ON.
9. Open gun air valve to blow out any remaining texture residue. Flush with water.

CAUTION	
If water freezes in unit, damage may occur. Store system where it will not freeze during cold weather.	

10. Turn air compressor OFF.

 Inspect slots under machine daily for texture material. If you find material flowing out of slots or see material inside unit, replace pump hose immediately.

# Troubleshooting

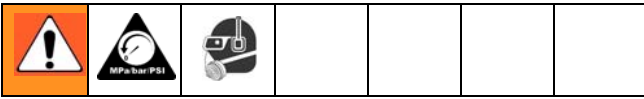

Problem	Cause	Solution
Sprayer won't run	Power switch not on	Turn switch on.
	No power at wall outlet	Check outlet by plugging in another appliance. If appliance does not work, try another outlet.
	Wrong size generator	Use a 3500 watt or larger generator. Refer to Generator Requirements, page 6.
	Breaker tripped	Reset breaker.
Pump won't pump material	Air lock	Open air valve on gun.
	Mix too thick	Add water to thin material. Use Material Thickness Gauge.
	Loose fittings	Check and retighten all fittings.
	Plugged gun	<b>Relieve Pressure</b> , page 6. Remove gun from hose. Clean gun.
	Pump hose worn out	Replace hose. Recommended hose replacement - once every year.
	Pump cold	Move pump to warm room and allow it to warm up or run hot water through sprayer.
Material runs out of bottom of sprayer	Pump hose worn out	Replace hose.
	Loose fittings	Check and retighten all fittings.
No air from compressor	Gun air valve closed	Open gun air valve.
	Low voltage	Check extension cord length and gauge. Replace if different than recommended. Refer to Grounding and Electrical Requirements, page 6.
	Gun needle plugged	Clean needle and retry.
	Worn compressor	Replace compressor. Contact a qualified Graco Service Center.
	Lines not connected	Check all quick disconnect connections to gun and hoses.
	Damaged hose	Replace hose.

<b>Problem</b>	<b>Cause</b>	<b>Solution</b>
Speed of application slow or slower	New pump hose not broken in properly	Run pump dry for no longer than 2 minutes.
	Material too thick	Thin material.
	Nozzle too small	Change nozzles to a larger size. See Recommended Nozzle Selection Chart, page 10.
	Too much air being used	Partially close gun air valve to reduce air flow.
	Pump hose worn	Replace hose.
	Plugged or dirty gun	<b>Relieve Pressure</b> , page 6. Clean gun.
	Kinked hose	Unkink hose.
	Gun adjustment set too low	Increase flow adjustment with flow adjustment nut.
	Too many items on same circuit	Unplug other items from circuit.
	Extension cord too long or wrong gauge	Use a different extension cord. Refer to Grounding and Electric Requirements, page 6.
Intermittent flow/sputtering	Hopper connection not tight	Check gasket. Tighten connection.
	Debris in system	Clean system.
Quick disconnect does not stay connected	Dirty or corroded fitting	Clean thoroughly. Soak in oil. Apply a few drops of light oil.
Gun will not shut off	Worn nozzle or needle	<b>Relieve Pressure</b> , page 6. Replace worn parts.
	Debris in needle passage	<b>Relieve Pressure</b> , page 6. Clean.
Fluid leaking at Flow Adjustment Nut	Damaged seal	<b>Relieve Pressure</b> , page 6. Replace seal.
Fluid leaking out of either plug	Missing or damaged o-rings	<b>Relieve Pressure</b> , page 6. Replace o-rings.
	Gun damaged	Replace gun.
Needle adjustment won't adjust	Dirty threads	Clean threads.
	Nozzle not on gun	Put nozzle on gun.

## Technical Data

Main Unit Power Requirements . . . . .	120 Vac, 60 Hz, 15A, 1 phase
Maximum Fluid Working Pressure . . . . .	50 psi, (3.5 bar)
Maximum Air Working Pressure . . . . .	100 psi (7.0 bar)
Compressor Specifications . . . . .	Universal motor thermally protected, oil-less
Compressor (Not Supplied) . . . . .	3.5 @ 40 psi minimum
Generator (Optional) . . . . .	3500 W minimum
Electric Motor . . . . .	Permanent Magnet DC-5A
Power Cord . . . . .	16 AWG, 3-wire, 15 ft
Material Hopper Capacity . . . . .	5 gallons
Maximum Delivery with Texture . . . . .	0.65 gpm
TX 65 Dimensions and Weight	
Length . . . . .	19 in. (482 mm) with handle
Width . . . . .	12 in. (305 mm)
Height (no handle) . . . . .	20 in. (508 mm)
Weight (includes hoses or gun) . . . . .	33 lb (14.9 kg)
Wetted Parts . . . . .	brass, aluminum, plastic
Sound Data (less compressor)	
Sound Pressure Level . . . . .	N/A
Sound Power Level . . . . .	N/A
Storage Temperature Range . . . . .	35°F - 160°F (1.6°C - 71°C)
Operating Temperature Range . . . . .	40°F - 115°F (4°C - 46°C)
Gun:	
Maximum Fluid Working Pressure . . . . .	70 psi (3.5 bar)
Maximum Air Working Pressure . . . . .	125 psi (8.75 bar)
CFM Rating . . . . .	3.0 - 11 CFM
Weight . . . . .	1.1 lb (500 g)



# Graco Warranty

Graco warrants all equipment referenced in this document which is manufactured by Graco and bearing its name to be free from defects in material and workmanship on the date of sale to the original purchaser for use. With the exception of any special, extended, or limited warranty published by Graco, Graco will, for a period of twelve months from the date of sale, repair or replace any part of the equipment determined by Graco to be defective. This warranty applies only when the equipment is installed, operated and maintained in accordance with Graco's written recommendations.

Graco warrants all equipment referenced in this document which is manufactured by Graco and bearing its name to be free from defects in material and workmanship on the date of sale by an authorized Graco distributor to the original purchaser for use. With the exception of any special, extended, or limited warranty published by Graco, Graco will, for a period of twelve months from the date of sale, repair or replace any part of the equipment determined by Graco to be defective. This warranty applies only when the equipment is installed, operated and maintained in accordance with Graco's written recommendations.

This warranty does not cover, and Graco shall not be liable for general wear and tear, or any malfunction, damage or wear caused by faulty installation, misapplication, abrasion, corrosion, inadequate or improper maintenance, negligence, accident, tampering, or substitution of non-Graco component parts. Nor shall Graco be liable for malfunction, damage or wear caused by the incompatibility of Graco equipment with structures, accessories, equipment or materials not supplied by Graco, or the improper design, manufacture, installation, operation or maintenance of structures, accessories, equipment or materials not supplied by Graco.

This warranty is conditioned upon the prepaid return of the equipment claimed to be defective to an authorized Graco distributor for verification of the claimed defect. If the claimed defect is verified, Graco will repair or replace free of charge any defective parts. The equipment will be returned to the original purchaser transportation prepaid. If inspection of the equipment does not disclose any defect in material or workmanship, repairs will be made at a reasonable charge, which charges may include the costs of parts, labor, and transportation.

**THIS WARRANTY IS EXCLUSIVE, AND IS IN LIEU OF ANY OTHER WARRANTIES, EXPRESS OR IMPLIED, INCLUDING BUT NOT LIMITED TO WARRANTY OF MERCHANTABILITY OR WARRANTY OF FITNESS FOR A PARTICULAR PURPOSE.**

Graco's sole obligation and buyer's sole remedy for any breach of warranty shall be as set forth above. The buyer agrees that no other remedy (including, but not limited to, incidental or consequential damages for lost profits, lost sales, injury to person or property, or any other incidental or consequential loss) shall be available. Any action for breach of warranty must be brought within two (2) years of the date of sale.

**GRACO MAKES NO WARRANTY, AND DISCLAIMS ALL IMPLIED WARRANTIES OF MERCHANTABILITY AND FITNESS FOR A PARTICULAR PURPOSE, IN CONNECTION WITH ACCESSORIES, EQUIPMENT, MATERIALS OR COMPONENTS SOLD BUT NOT MANUFACTURED BY GRACO.** These items sold, but not manufactured by Graco (such as electric motors, switches, hose, etc.), are subject to the warranty, if any, of their manufacturer. Graco will provide purchaser with reasonable assistance in making any claim for breach of these warranties.

In no event will Graco be liable for indirect, incidental, special or consequential damages resulting from Graco supplying equipment hereunder, or the furnishing, performance, or use of any products or other goods sold hereto, whether due to a breach of contract, breach of warranty, the negligence of Graco, or otherwise.

For the latest information about Graco products, visit [www.graco.com](http://www.graco.com).

**TO PLACE AN ORDER,** contact your Graco distributor or call 1-800-690-2894 to identify the nearest distributor.

*All written and visual data contained in this document reflects the latest product information available at the time of publication. Graco reserves the right to make changes at any time without notice.*

*For patent information, see [www.graco.com/patents](http://www.graco.com/patents).*

Original instructions. This manual contains English. MM 311763

**Graco Headquarters:** Minneapolis

**International Offices:** Belgium, China, Japan, Korea

**GRACO INC. AND SUBSIDIARIES • P.O. BOX 1441 • MINNEAPOLIS MN 55440-1441 • USA**

**Copyright 2007, Graco Inc. All Graco manufacturing locations are registered to ISO 9001.**

[www.graco.com](http://www.graco.com)

Revised September 2012