

332161A

EN

## RentalPro 210 Electric Airless Sprayer, Lo-Boy

- For portable spray applications of architectural paints and coatings -

### Model 262906

3300 psi (22.7 MPa, 227 bar) Maximum Working Pressure



#### Important Safety Instructions

Read all warnings and instructions in this manual. Save these instructions.

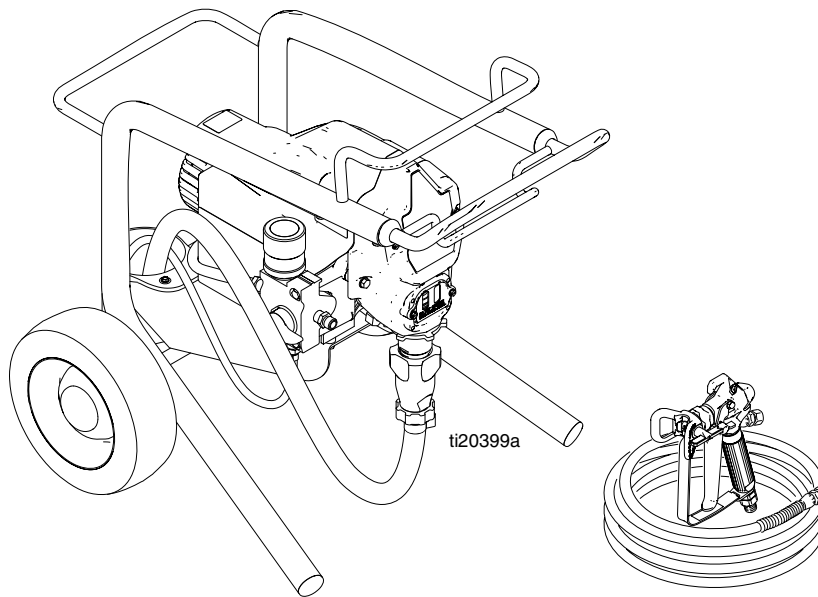

332162



312830  
English

312831  
Français

312832  
Español



309250



Intertek

# Warnings

The following warnings are for the setup, use, grounding, maintenance, and repair of this equipment. The exclamation point symbol alerts you to a general warning and the hazard symbols refer to procedure-specific risks. When these symbols appear in the body of this manual or on warning labels, refer back to these Warnings. Product-specific hazard symbols and warnings not covered in this section may appear throughout the body of this manual where applicable.

## Grounding Instructions

### **WARNING**



#### **GROUNDING**

This product must be grounded. In the event of an electrical short circuit, grounding reduces the risk of electric shock by providing an escape wire for the electric current. This product is equipped with a cord having a grounding wire with an appropriate grounding plug. The plug must be plugged into an outlet that is properly installed and grounded in accordance with all local codes and ordinances.

- Improper installation of the grounding plug is able to result in a risk of electric shock.
- When repair or replacement of the cord or plug is required, do not connect the grounding wire to either flat blade terminal.
- The wire with insulation having an outer surface that is green with or without yellow stripes is the grounding wire.
- Check with a qualified electrician or serviceman when the grounding instructions are not completely understood, or when in doubt as to whether the product is properly grounded.
- Do not modify the plug provided; if it does not fit the outlet, have the proper outlet installed by a qualified electrician.
- This product is for use on a nominal 120V circuit and has a grounding plug similar to the plug illustrated in the figure below.

120V US

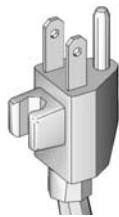

- Only connect the product to an outlet having the same configuration as the plug.
- Do not use an adapter with this product.

#### Extension Cords:

- Use only a 3-wire extension cord that has a 3-blade grounding plug and a 3-slot receptacle that accepts the plug on the product.
- Make sure your extension cord is not damaged. If an extension cord is necessary, use 12 AWG (2.5 mm<sup>2</sup>) minimum to carry the current that the product draws.
- An undersized cord results in a drop in line voltage and loss of power and overheating.

# ! WARNING



## FIRE AND EXPLOSION HAZARD

Flammable fumes, such as solvent and paint fumes, in work area can ignite or explode. To help prevent fire and explosion:

- Do not spray flammable or combustible materials near an open flame or sources of ignition such as cigarettes, motors, and electrical equipment.
- Paint or solvent flowing through the equipment is able to result in static electricity. Static electricity creates a risk of fire or explosion in the presence of paint or solvent fumes. All parts of the spray system, including the pump, hose assembly, spray gun, and objects in and around the spray area shall be properly grounded to protect against static discharge and sparks. Use Graco conductive or grounded high-pressure airless paint sprayer hoses.
- Verify that all containers and collection systems are grounded to prevent static discharge. Do not use pail liners unless they are antistatic or conductive.
- Connect to a grounded outlet and use grounded extensions cords. Do not use a 3-to-2 adapter.
- Do not use a paint or a solvent containing halogenated hydrocarbons.
- Keep spray area well-ventilated. Keep a good supply of fresh air moving through the area. Keep pump assembly in a well ventilated area. Do not spray pump assembly.
- Do not smoke in the spray area.
- Do not operate light switches, engines, or similar spark producing products in the spray area.
- Keep area clean and free of paint or solvent containers, rags, and other flammable materials.
- Know the contents of the paints and solvents being sprayed. Read all Material Safety Data Sheets (MSDS) and container labels provided with the paints and solvents. Follow the paint and solvents manufacturer's safety instructions.
- Fire extinguisher equipment shall be present and working.
- Sprayer generates sparks. When flammable liquid is used in or near the sprayer or for flushing or cleaning, keep sprayer at least 20 feet (6 m) away from explosive vapors.









## SKIN INJECTION HAZARD

High-pressure spray is able to inject toxins into the body and cause serious bodily injury. In the event that injection occurs, **get immediate surgical treatment.**

- Do not aim the gun at, or spray any person or animal.
- Keep hands and other body parts away from the discharge. For example, do not try to stop leaks with any part of the body.
- Always use the nozzle tip guard. Do not spray without nozzle tip guard in place.
- Use Graco nozzle tips.
- Use caution when cleaning and changing nozzle tips. In the case where the nozzle tip clogs while spraying, follow the **Pressure Relief Procedure** for turning off the unit and relieving the pressure before removing the nozzle tip to clean.
- Do not leave the unit energized or under pressure while unattended. When the unit is not in use, turn off the unit and follow the **Pressure Relief Procedure** for turning off the unit.
- Check hoses and parts for signs of damage. Replace any damaged hoses or parts.
- This system is capable of producing 3300 psi (22.7 MPa, 227 bar). Use Graco replacement parts or accessories that are rated a minimum of 3300 psi (22.7 MPa, 227 bar).
- Always engage the trigger lock when not spraying. Verify the trigger lock is functioning properly.
- Verify that all connections are secure before operating the unit.
- Know how to stop the unit and bleed pressure quickly. Be thoroughly familiar with the controls.

# ! WARNING

	<p><b>EQUIPMENT MISUSE HAZARD</b> Misuse can cause death or serious injury.</p> <ul style="list-style-type: none"> <li>• Always wear appropriate gloves, eye protection, and a respirator or mask when painting.</li> <li>• Do not operate or spray near children. Keep children away from equipment at all times.</li> <li>• Do not overreach or stand on an unstable support. Keep effective footing and balance at all times.</li> <li>• Stay alert and watch what you are doing.</li> <li>• Do not leave the unit energized or under pressure while unattended. When the unit is not in use, turn off the unit and follow the <b>Pressure Relief Procedure</b> for turning off the unit.</li> <li>• Do not operate the unit when fatigued or under the influence of drugs or alcohol.</li> <li>• Do not kink or over-bend the hose.</li> <li>• Do not expose the hose to temperatures or to pressures in excess of those specified by Graco.</li> <li>• Do not use the hose as a strength member to pull or lift the equipment.</li> <li>• Do not spray with a hose shorter than 25 feet.</li> <li>• Do not alter or modify equipment. Alterations or modifications may void agency approvals and create safety hazards.</li> <li>• Make sure all equipment is rated and approved for the environment in which you are using it.</li> </ul>
	<p><b>ELECTRIC SHOCK HAZARD</b> This equipment must be grounded. Improper grounding, setup, or usage of the system can cause electric shock.</p> <ul style="list-style-type: none"> <li>• Turn off and disconnect power cord before servicing equipment.</li> <li>• Connect only to grounded electrical outlets.</li> <li>• Use only 3-wire extension cords.</li> <li>• Ensure ground prongs are intact on power and extension cords.</li> <li>• Do not expose to rain. Store indoors</li> <li>• Wait five minutes after disconnecting power cord before servicing large capacitor units.</li> </ul>
	<p><b>PRESSURIZED ALUMINUM PARTS HAZARD</b> Use of fluids that are incompatible with aluminum in pressurized equipment can cause serious chemical reaction and equipment rupture. Failure to follow this warning can result in death, serious injury, or property damage.</p> <ul style="list-style-type: none"> <li>• Do not use 1,1,1-trichloroethane, methylene chloride, other halogenated hydrocarbon solvents or fluids containing such solvents.</li> <li>• Many other fluids may contain chemicals that can react with aluminum. Contact your material supplier for compatibility.</li> </ul>
	<p><b>BURN HAZARD</b> Equipment surfaces and fluid that's heated can become very hot during operation. To avoid severe burns:</p> <ul style="list-style-type: none"> <li>• Do not touch hot fluid or equipment.</li> </ul>
	<p><b>MOVING PARTS HAZARD</b> Moving parts can pinch, cut or amputate fingers and other body parts.</p> <ul style="list-style-type: none"> <li>• Keep clear of moving parts.</li> <li>• Do not operate equipment with protective guards or covers removed.</li> <li>• Pressurized equipment can start without warning. Before checking, moving, or servicing equipment, follow the <b>Pressure Relief Procedure</b> and disconnect all power sources.</li> </ul>
	<p><b>TOXIC FLUID OR FUMES HAZARD</b> Toxic fluids or fumes can cause serious injury or death if splashed in the eyes or on skin, inhaled, or swallowed.</p> <ul style="list-style-type: none"> <li>• Read MSDSs to know the specific hazards of the fluids you are using.</li> <li>• Store hazardous fluid in approved containers, and dispose of it according to applicable guidelines.</li> </ul>
	<p><b>PERSONAL PROTECTIVE EQUIPMENT</b> Wear appropriate protective equipment when in the work area to help prevent serious injury, including eye injury, hearing loss, inhalation of toxic fumes, and burns. This protective equipment includes but is not limited to:</p> <ul style="list-style-type: none"> <li>• Protective eyewear, and hearing protection.</li> <li>• Respirators, protective clothing, and gloves as recommended by the fluid and solvent manufacturer.</li> </ul>

# Component Identification

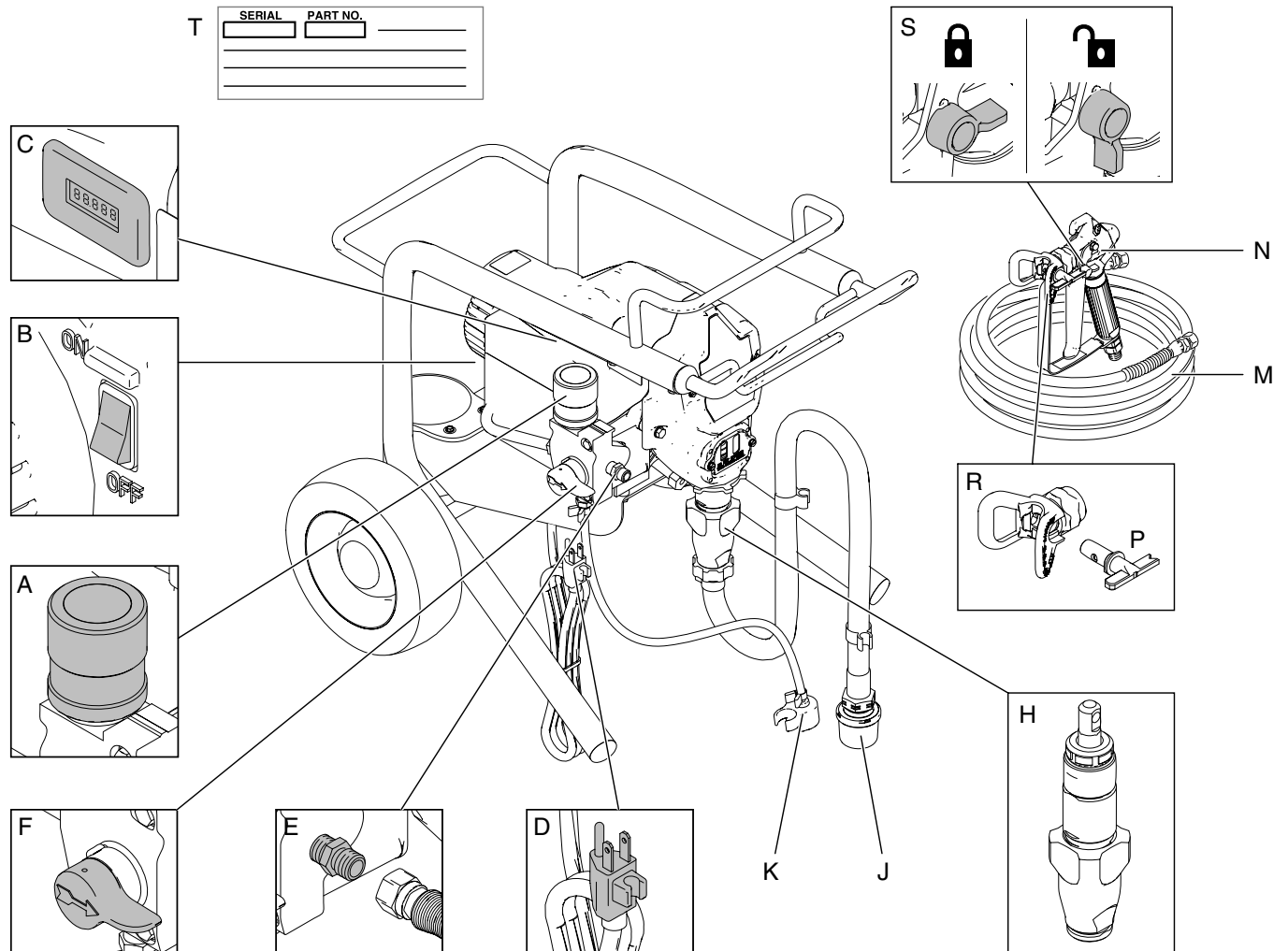

A	Pressure Control
B	ON/OFF switch
C	Hour Meter
D	Power Cord
E	Fluid Outlet
F	Prime Valve
H	Pump

J	Suction Hose
K	Drain Hose
M	Fluid Hose
N	Gun
P	Tip
R	Guard
S	Trigger Safety Lock
T	Serial Number ID Label

# Pressure Relief Procedure



Follow the Pressure Relief Procedure whenever you see this symbol.



This equipment stays pressurized until pressure is manually relieved. To help prevent serious injury from pressurized fluid, such as skin injection, splashing fluid and moving parts, follow the Pressure Relief Procedure when you stop spraying and before cleaning, checking, or servicing the equipment.

1. Turn pressure control to lowest pressure.

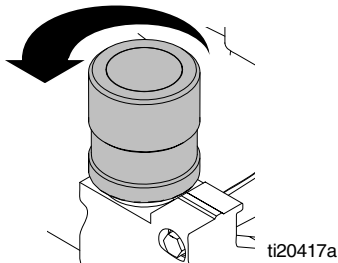

2. Hold gun against side of grounded metal flushing pail. Trigger gun to relieve pressure.

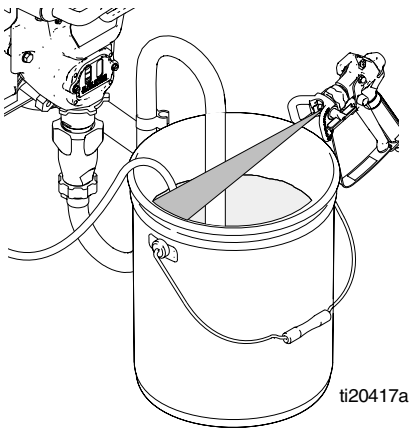

3. Turn prime valve down. If you suspect spray tip or hose is clogged or pressure is not fully relieved, VERY SLOWLY loosen tip guard retaining nut or hose end coupling to relieve pressure. Then loosen completely.

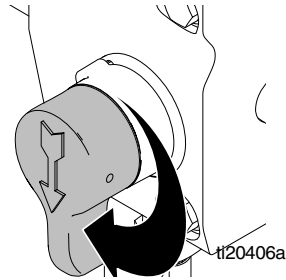

4. Turn power switch OFF, if unit is being shut down or will be left unattended.

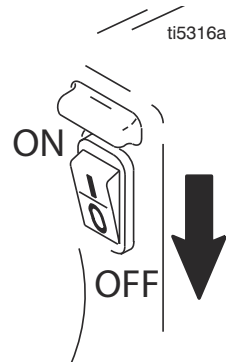

# Grounding

<p>The equipment must be grounded to reduce the risk of static sparking. Static sparking can cause fumes to ignite or explode. Grounding provides an escape wire for the electric current.</p>						

**Air and fluid hoses:** use only electrically conductive hoses with a maximum of 500 ft. (150 m) combined hose length to ensure grounding continuity. Check electrical resistance of hoses. If total resistance to ground exceeds 29 megohms, replace hose immediately.

**Spray gun:** ground through connection to a properly grounded fluid hose and pump.

**Fluid supply container:** follow local code.

**Object being sprayed:** follow local code.

<p>The plug must be plugged into an outlet that is properly installed and grounded in accordance with all local codes and ordinances.</p>						

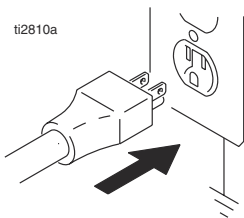

<p>Do not modify plug! If it will not fit in outlet, have grounded outlet installed by a qualified electrician. Do not use an adapter.</p>						

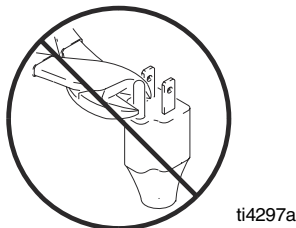

## Power Requirements

100-120V units require 100-120 VAC, 60 Hz, 11A, 1 phase.

## Extension Cords

- Use an extension cord with an undamaged ground contact.
- If an extension cord is necessary, use a 3-wire, 12 AWG (2.5 mm<sup>2</sup>) minimum.

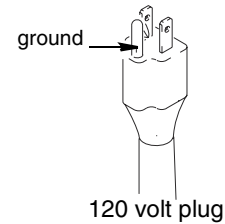

## Pails

**Solvent and oil/based fluids:** follow local code. Use only conductive metal pails, placed on a grounded surface. Do not place the pail on a nonconductive surface, such as paper or cardboard, which interrupts grounding continuity.

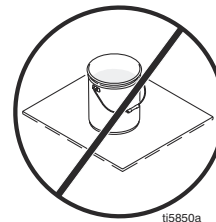

**Grounding a metal pail:** connect a ground wire to the pail by clamping one end to pail and other end to a true earth ground such as a water pipe.

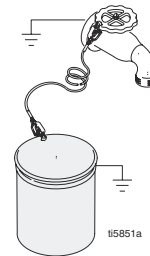

**To maintain grounding continuity when flushing or relieving pressure:** hold metal part of spray gun firmly to side of a grounded metal pail. Then trigger gun.

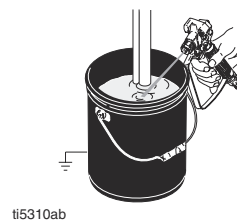

# Setup

1. Connect Graco airless hose to sprayer. Tighten securely.

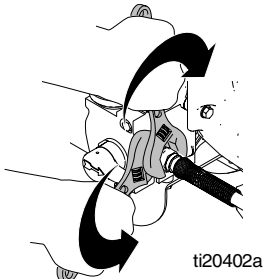

2. Connect other end of hose to gun.

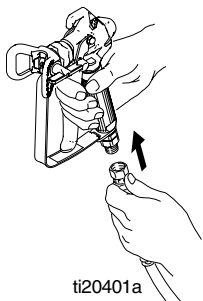

3. Tighten securely.

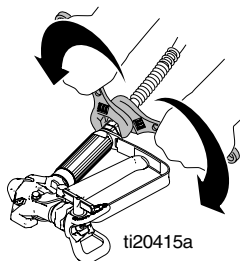

4. Remove tip guard.

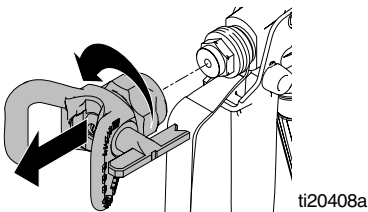

5. Check inlet strainer for clogs and debris.

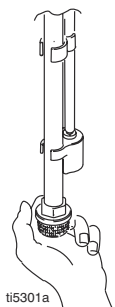

6. Fill throat packing nut with TSL to prevent premature packing wear. Do this each time you spray.

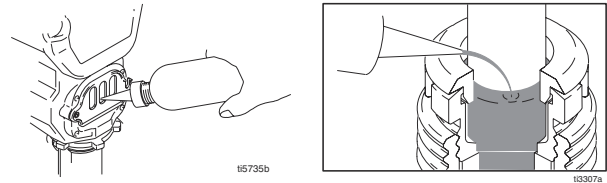

7. Turn power OFF.

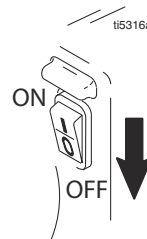

8. Plug power supply cord into a properly grounded electrical outlet.

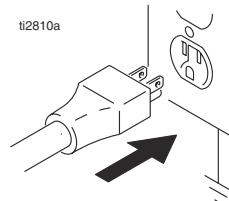

9. Turn prime valve down.

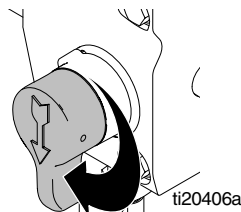

10. Place siphon tube set in grounded metal pail partially filled with flushing fluid. See **Grounding**, page 7. Do steps 1- 6 of **Startup**, page 9, to flush out storage oil shipped in sprayer. Use water to flush water-based paint or mineral spirits to flush oil-based paint and storage oil.

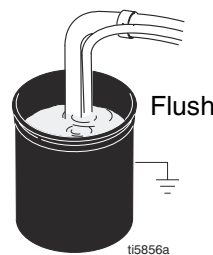



# Startup

1. Turn pressure control to lowest pressure.

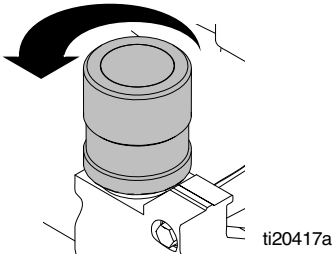

2. Turn power **ON**.

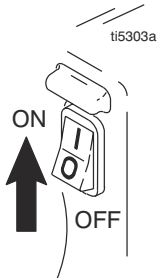

3. Increase pressure 1/4 turn to start motor. Allow fluid to circulate through drain tube for 15 seconds.

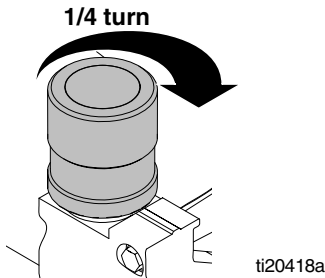

4. Turn prime valve horizontal. Take spray gun trigger safety **OFF**.

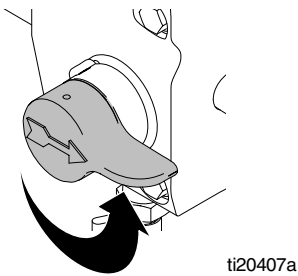

5. Hold gun against grounded metal flushing pail. Trigger gun and flush 1 minute.

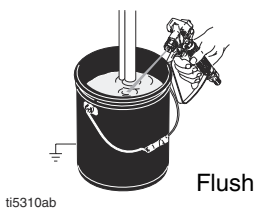

6. Inspect for leaks. Do not stop leaks with hand or a rag! If leaks occur, perform **Pressure Relief Procedure**, page 6. Tighten fittings.

7. Place siphon tube in paint pail.

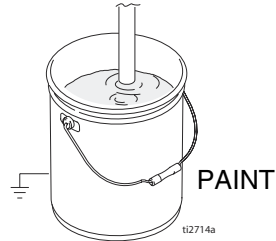

8. Trigger gun again into flushing pail until paint appears.

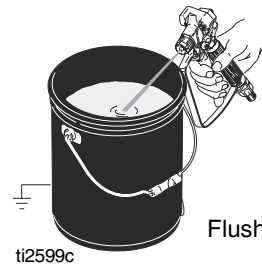

9. Move gun to paint pail and trigger for 20 seconds. Set gun safety **ON**.

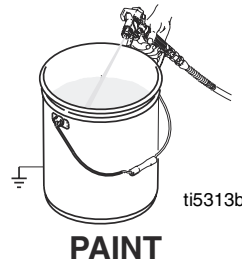

Do NOT place hands in front of tip.		

10. Screw tip assembly onto gun. Tighten. For gun assembly instructions, see gun manual.

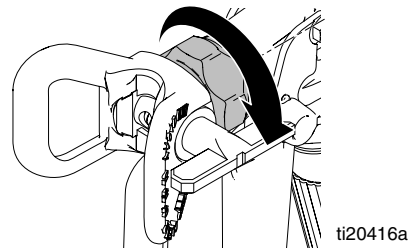

## Spray Test Pattern

1. Spray test pattern. Adjust pressure to eliminate heavy edges.

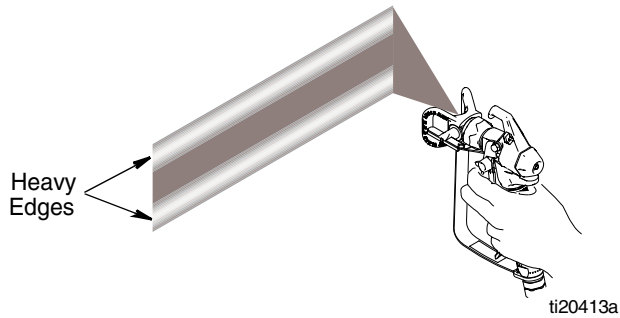

2. Use smaller tip size if pressure adjustment cannot eliminate heavy edges.
3. Hold gun perpendicular, 10-12 in. from surface. Spray back and forth; overlap by 50%.

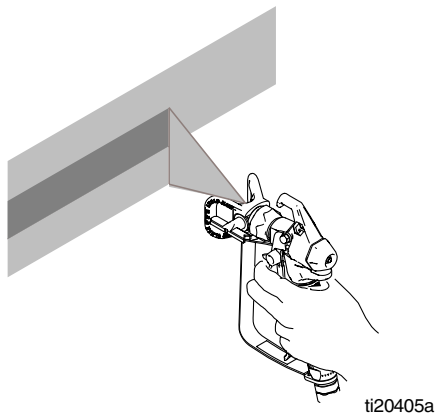

4. Trigger gun before moving. Release before stopping. For additional spraying information, see gun manual 311861.

## Clearing Clogs



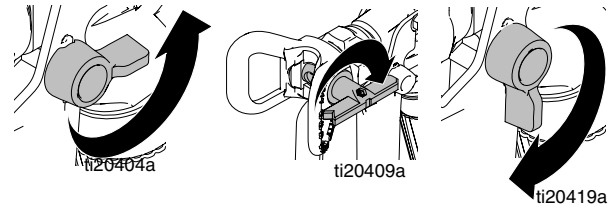

1. Release trigger, put safety ON. Rotate Spray Tip. Take safety OFF. Trigger gun to clear clog.

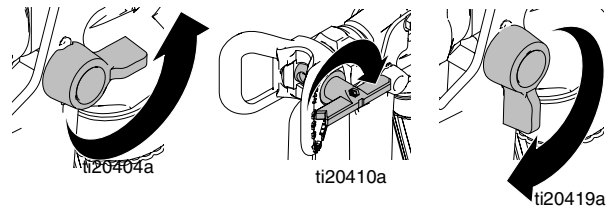

2. Put safety ON. Return Spray Tip to original position. Take safety OFF and continue spraying.



# Cleanup

						
<p>This equipment stays pressurized until pressure is manually relieved. To help prevent serious injury from pressurized fluid, such as skin injection, splashing fluid and moving parts, follow the Pressure Relief Procedure when you stop spraying and before cleaning, checking, or servicing the equipment.</p>						

1. Perform **Relieve Pressure Procedure**, page 6.
2. Remove guard and Spray Tip. For additional information, see gun manual.

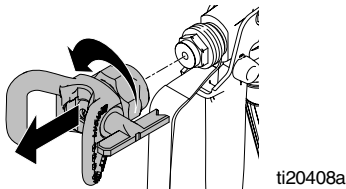

3. Remove siphon tube set from paint. Wipe excess paint off outside of tubes.
4. Place siphon tube in flushing fluid. Use water for water base paint and mineral spirits for oil base paint. Place drain tube in waste pail.

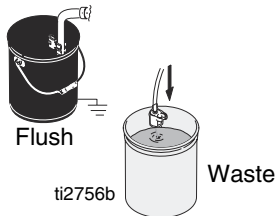

5. Turn prime valve horizontal.

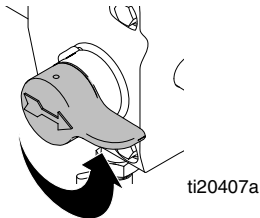

6. Hold gun against paint pail. Take trigger safety OFF. Trigger gun and increase pressure until the pump runs steady and flushing fluid appears.

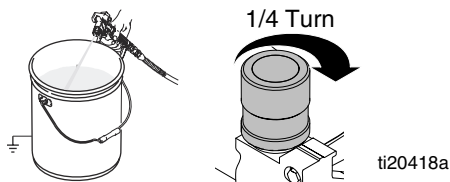

7. Stop triggering gun. Move gun to waste pail, hold gun against pail, trigger gun to thoroughly flush system.

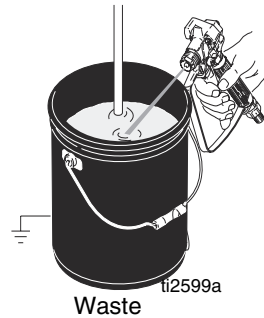

8. While continuing to trigger gun, turn prime valve down. Then, release gun trigger. Allow flushing fluid to circulate until fluid coming out of drain tube is clear.

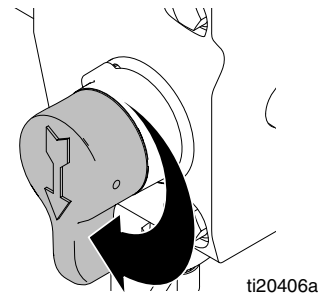

9. Raise siphon tube above flushing fluid.



10. Close drain valve. Trigger gun into flushing pail to purge fluid from hose.



Cleanup

- Turn pressure control knob all the way down and power switch OFF. Unplug sprayer.

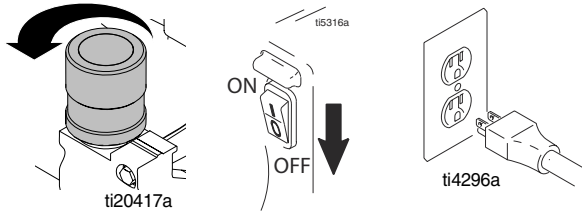

- Remove filter from gun if installed. Clean and inspect. Install filter. See gun manual.
- If flushing with water, flush again with mineral spirits or Pump Armor to leave a protective coating to prevent freezing or corrosion.

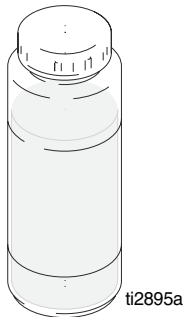

- Wipe sprayer, hose and gun with a rag soaked in water or mineral spirits.

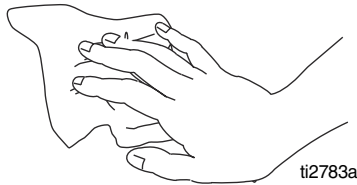

- Insert suction tube into cup to catch any drips.

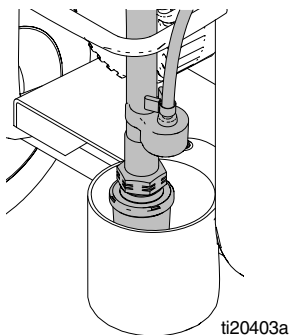

## Power Flush™

Power flushing is a faster method of flushing. It can only be used after spraying water-based coatings.

<p>This equipment stays pressurized until pressure is manually relieved. To help prevent serious injury from pressurized fluid, such as skin injection, splashing fluid and moving parts, follow the Pressure Relief Procedure when you stop spraying and before cleaning, checking, or servicing the equipment.</p>						

- Perform **Relieve Pressure Procedure**, page 6.
- Remove guard and spray tip. For additional information, see gun manual.

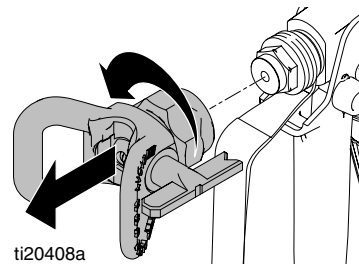

- Remove siphon tube set from paint. Wipe excess paint off outside of tubes.
- Unscrew inlet strainer from suction tube. Place inlet screen in waste pail.

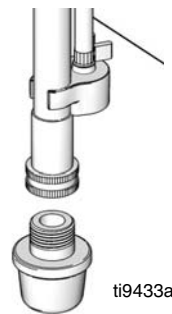

- Screw shutoff valve onto garden hose. Turn lever and open valve.

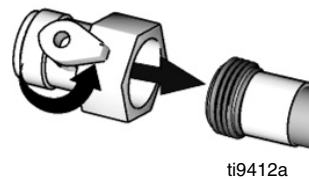

6. Turn on water. Rinse paint off suction tube, prime tube and inlet screen. Close valve.

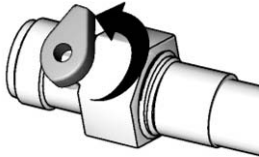

ti9413a

7. Connect shutoff valve and garden hose to suction tube. Leave prime tube in waste pail.



ti10443a

8. Turn Spray-Prime/Drain valve to SPRAY.

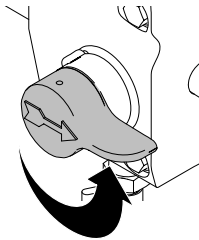

i407a

9. Open lever on shut-off valve.



ti10447a

10. Turn Pressure Control knob 1/4 turn clockwise.

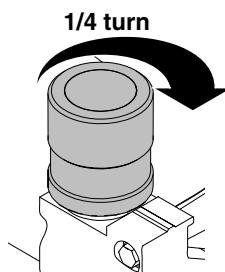

ti20418a

**NOTE:** Step 11 is for returning paint in hose back to paint pail. One 50-ft (15-m) hose holds approximately 1-quart (1-liter) of paint.

11. Remove paint from hose.

- a. Pull and hold gun trigger. Point gun into paint pail.
- b. Turn power switch ON to begin pumping paint in hose back into paint pail.

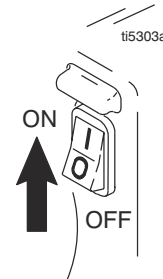

ti5303a

- c. When water comes out of gun, continue to trigger gun, aiming gun into waste pail.

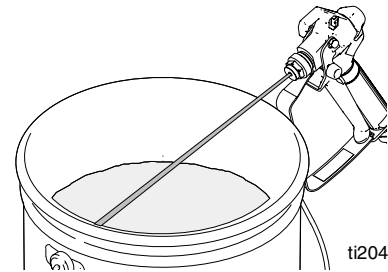

ti20411a

12. Continue triggering gun into waste pail for 1-2 minutes, until relatively clear water comes out of gun.

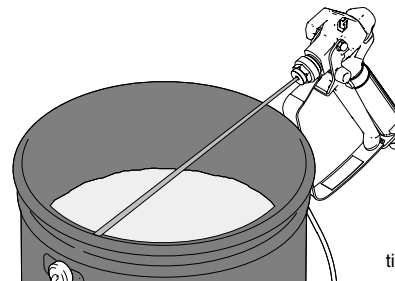

ti20412a

13. Turn Spray-Prime/Drain valve to PRIME.

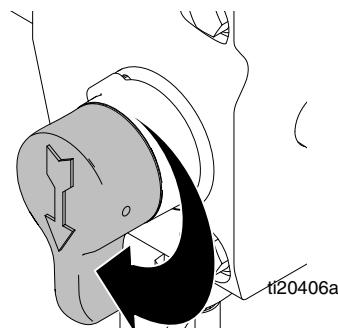

ti20406a

Cleanup

- 14. Circulate water through sprayer, into waste pail, for 20 seconds.
- 15. Turn power switch OFF.

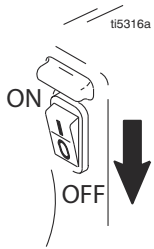

- 16. Close shutoff valve. Turn off water from garden hose.

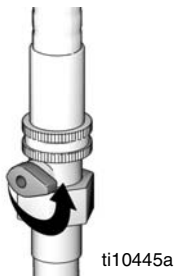

- 17. Unscrew shutoff valve from garden hose. Remove power flush adapter from suction tube. Install inlet strainer.



- 18. Close drain valve. Turn power ON. Trigger gun into flushing pail to purge fluid from hose.

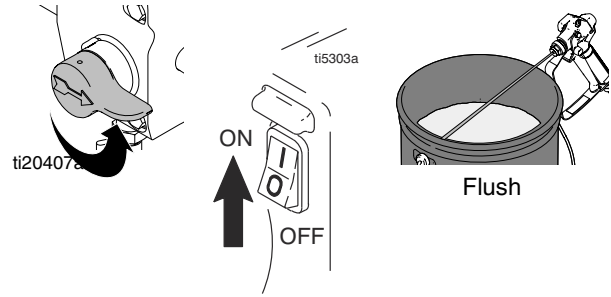

- 19. Turn pressure control knob all the way down and power switch OFF. Unplug sprayer.

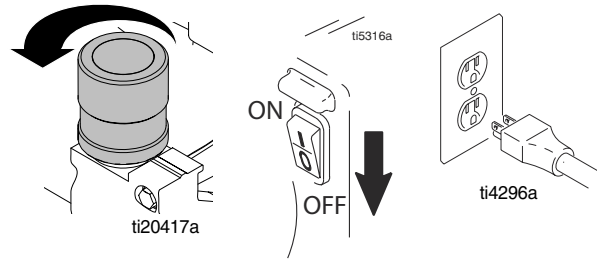

# Technical Data

Power requirements . . . . .	100/120V AC, 60 hz, 11A, 1 phase
Generator required . . . . .	3000 w minimum
Maximum working pressure . . . . .	3300 psi (22.7 MPa, 227 bar)
Cycles per gallon (liter) . . . . .	680 (180)
Maximum delivery gpm (lpm) . . . . .	0.47 (1.8)
Maximum tip size . . . . .	0.021
Fluid outlet npsm . . . . .	1/4 in.
Dimensions	
Length . . . . .	26.0 in. (66.0 cm)
Width . . . . .	20.5 in. (52.1 cm)
Height . . . . .	21.0 in. (53.3 cm)
Weight . . . . .	50 lbs (22.7 kg)
Wetted parts . . . . .	zinc and nickel-plated carbon steel, nylon, stainless steel, PTFE, Acetal, leather, UHMWPE, aluminum, tungsten carbide
Noise level*	
Sound power (ISO 3744)	100dBa*
Sound pressure (ISO 3744)	90 dBa*

*\*Measured 3 feet (1 meter) from equipment.*

# Graco Standard Warranty

Graco warrants all equipment referenced in this document which is manufactured by Graco and bearing its name to be free from defects in material and workmanship on the date of sale to the original purchaser for use. With the exception of any special, extended, or limited warranty published by Graco, Graco will, for a period of twelve months from the date of sale, repair or replace any part of the equipment determined by Graco to be defective. This warranty applies only when the equipment is installed, operated and maintained in accordance with Graco's written recommendations.

This warranty does not cover, and Graco shall not be liable for general wear and tear, or any malfunction, damage or wear caused by faulty installation, misapplication, abrasion, corrosion, inadequate or improper maintenance, negligence, accident, tampering, or substitution of non-Graco component parts. Nor shall Graco be liable for malfunction, damage or wear caused by the incompatibility of Graco equipment with structures, accessories, equipment or materials not supplied by Graco, or the improper design, manufacture, installation, operation or maintenance of structures, accessories, equipment or materials not supplied by Graco.

This warranty is conditioned upon the prepaid return of the equipment claimed to be defective to an authorized Graco distributor for verification of the claimed defect. If the claimed defect is verified, Graco will repair or replace free of charge any defective parts. The equipment will be returned to the original purchaser transportation prepaid. If inspection of the equipment does not disclose any defect in material or workmanship, repairs will be made at a reasonable charge, which charges may include the costs of parts, labor, and transportation.

**THIS WARRANTY IS EXCLUSIVE, AND IS IN LIEU OF ANY OTHER WARRANTIES, EXPRESS OR IMPLIED, INCLUDING BUT NOT LIMITED TO WARRANTY OF MERCHANTABILITY OR WARRANTY OF FITNESS FOR A PARTICULAR PURPOSE.**

Graco's sole obligation and buyer's sole remedy for any breach of warranty shall be as set forth above. The buyer agrees that no other remedy (including, but not limited to, incidental or consequential damages for lost profits, lost sales, injury to person or property, or any other incidental or consequential loss) shall be available. Any action for breach of warranty must be brought within two (2) years of the date of sale.

**GRACO MAKES NO WARRANTY, AND DISCLAIMS ALL IMPLIED WARRANTIES OF MERCHANTABILITY AND FITNESS FOR A PARTICULAR PURPOSE, IN CONNECTION WITH ACCESSORIES, EQUIPMENT, MATERIALS OR COMPONENTS SOLD BUT NOT MANUFACTURED BY GRACO.** These items sold, but not manufactured by Graco (such as electric motors, switches, hose, etc.), are subject to the warranty, if any, of their manufacturer. Graco will provide purchaser with reasonable assistance in making any claim for breach of these warranties.

In no event will Graco be liable for indirect, incidental, special or consequential damages resulting from Graco supplying equipment hereunder, or the furnishing, performance, or use of any products or other goods sold hereto, whether due to a breach of contract, breach of warranty, the negligence of Graco, or otherwise.

## Graco Information

For the latest information about Graco products, visit [www.graco.com](http://www.graco.com).

**TO PLACE AN ORDER**, contact your Graco distributor or call 1-800-690-2894 to identify the nearest distributor.

*All written and visual data contained in this document reflects the latest product information available at the time of publication.  
Graco reserves the right to make changes at any time without notice.*

For patent information, see [www.graco.com/patents](http://www.graco.com/patents).

Original instructions. This manual contains English. MM 332161

**Graco Headquarters:** Minneapolis

**International Offices:** Belgium, China, Japan, Korea

**GRACO INC. AND SUBSIDIARIES • P.O. BOX 1441 • MINNEAPOLIS MN 55440-1441 • USA**  
**Copyright 2008, Graco Inc. All Graco manufacturing locations are registered to ISO 9001.**

[www.graco.com](http://www.graco.com)

Revision A - November 2012