

Instructions



Pro Xpc™ Auto Controller

333266H
EN

For controlling the Graco Pro Xpc Auto Electrostatic Spray Guns. For professional use only.
Not approved for use in explosive atmospheres or hazardous locations.



Important Safety Instructions

Read all warnings and instructions in this manual and in your Pro Xpc™ Auto Electrostatic Air Spray Gun manual. **Save these instructions.**

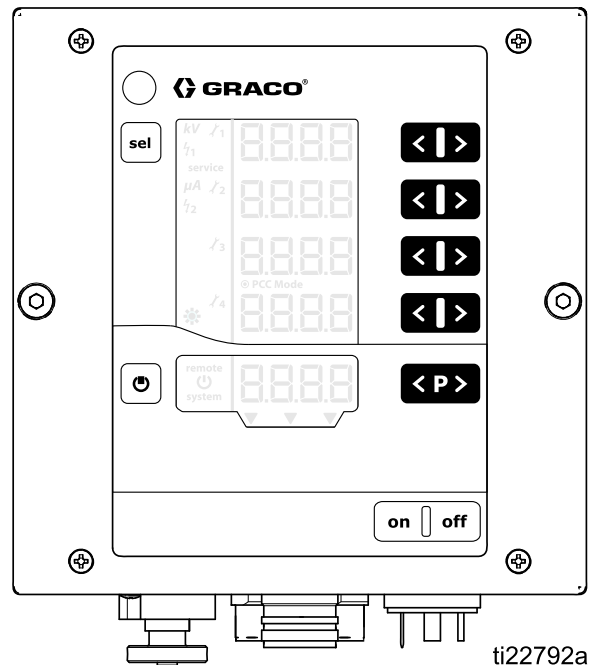

Contents







Models	3	Controller Display and Features.....	35
Approved System Components	3	Screen Areas.....	35
Related Manuals	3	Icons.....	35
Warnings	4	Input Keys and Switches	36
Introduction	6	Additional Features	36
Controller Features and Options	6	Setup.....	38
Installation.....	7	Setup Screen 0 (System Type)	40
Interlocks.....	7	Setup Screen 1 (Electrostatics Control	
Installation Options	9	Mode).....	40
No Integration.....	10	Setup Screen 2 (Remote Interface)	41
Basic Integration.....	11	Setup Screen 3 (Analog Input Type	
PLC Integration.....	12	Select).....	42
Pre-Installation Steps.....	13	Setup Screen 4 (Analog Output Type	
Ventilate the Spray Booth	13	Select).....	42
Install the Pro Xpc Auto Spray Gun	13	Setup Screen 6 (CAN Purpose ID)	43
Interlock Waterborne Isolation		Setup Screen 7 (Log Level)	43
Enclosure.....	13	Setup Screen 8 (Averaging Interval).....	44
Mount the Controller	14	Setup Screen 9 (Blanking Time).....	44
Location	14	Setup Screen 10 (Discharge Time).....	45
Mounting	14	Setup Screen 11 (Transition Time).....	45
Grounding	15	Operation.....	46
Controller Connections.....	16	System Start-up.....	46
Overview.....	16	Presets.....	46
Connections	17	Run Screen 1 (Electrostatics	
Discrete I/O.....	19	Readings)	47
Isolation	19	Run Screen 2 (Arc Limits).....	48
I/O Grounding.....	19	Run Screen 3 (Maintenance Counters).....	49
REMOTE Input Operation.....	19	Arc Detection.....	50
REMOTE Output Operation.....	19	Screen Map.....	52
Signals.....	20	Troubleshooting.....	55
Analog Inputs	24	Error Codes.....	55
Analog Outputs.....	24	Gun Power Cable Continuity.....	57
Digital Inputs.....	25	Repair.....	58
Digital Outputs.....	25	Main Circuit Board or Keypad Membrane	
Discrete I/O Interface Connections.....	25	Removal	58
Operation Modes and Timing Diagrams	26	Power Board Removal	60
Standby Mode	27	Software Update.....	61
SAFE POSITION Mode.....	28	Parts.....	63
Spray	30	Dimensions	64
Error Handling	32	Technical Data	67
Purge.....	34		

Models

Controller	Description	Maximum Gun Voltage Output
24Y307	Pro Xpc Auto Controller, solventborne	100 kV
24Y308	Pro Xpc Auto Controller, waterborne	60 kV

Approved System Components

Specific controllers, guns, and gun power cables must be used together. Refer to the table below for compatible models.







Controller	Gun Models	Gun Power Cables	Product Type	Controller Approvals
24Y307	LC1020 LC2020	17H040 17H041 17H042	Solvent-borne	  PTB 15 ATEX 5013 EN 50050-1, EN 50176  RECOGNIZED COMPONENT  Intertek 9902471 Conforms to UL STD 61010-1 and UL STD 61010-2-201 Cert. to CSA STD C22.2#61010-1 and CSA/IEC STD 61010-2-201:2014
24Y308	LC1028 LC2028	17H040 17H041 17H042	Waterborne	 RECOGNIZED COMPONENT  Intertek 9902471 Conforms to UL STD 61010-1 and UL STD 61010-2-201 Cert. to CSA STD C22.2#61010-1 and CSA/IEC STD 61010-2-201:2014







Related Manuals

Manual No.	Description
332992	Pro Xpc Auto Electrostatic Air Spray Gun

Warnings

The following warnings are for the setup, use, grounding, maintenance, and repair of this equipment. The exclamation point symbol alerts you to a general warning and the hazard symbols refer to procedure-specific risks. When these symbols appear in the body of this manual or on warning labels, refer back to these Warnings. Product-specific hazard symbols and warnings not covered in this section may appear throughout the body of this manual where applicable.

 <h2 style="margin: 0;">WARNING</h2>	
   	<p>FIRE AND EXPLOSION HAZARD</p> <p>Flammable fumes, such as solvent and paint fumes, in work location can ignite or explode. Paint or solvent flowing through the system can cause static sparking. To help prevent fire or explosion:</p> <ul style="list-style-type: none"> • Electrostatic equipment must be used only by trained, qualified personnel who understand the requirements of this manual. • Ground all equipment, personnel, object being sprayed, and conductive objects in or close to the spray location. Resistance must not exceed 1 megohm. See Grounding instructions. • Do not use pail liners unless they are conductive and grounded. • Stop operation immediately if static sparking occurs. Do not use equipment until you identify and correct the problem. • Check gun resistance and electrical grounding daily. • Use and clean equipment only in a well ventilated location. • Never spray or flush solvent at high pressure. • Always turn the electrostatics off when flushing, cleaning, or servicing equipment. • Eliminate all ignition sources; such as pilot lights, cigarettes, portable electric lamps, and plastic drop cloths (potential static arc). • Do not plug or unplug power cords or turn lights on or off when flammable fumes are present. • Keep spray location free of debris, including solvent, rags, and gasoline. • Keep a working fire extinguisher in the work location. <p>For solventborne systems only:</p> <ul style="list-style-type: none"> • Use cleaning solvents with highest possible flash point when flushing or cleaning equipment. <p>For waterborne systems only:</p> <ul style="list-style-type: none"> • Do not spray or clean with flammable materials. Use water-based materials only.
 	<p>ELECTRIC SHOCK HAZARD</p> <p>This equipment must be grounded. Improper grounding, setup, or usage of the system can cause electric shock.</p> <ul style="list-style-type: none"> • Turn off and disconnect power at main switch before disconnecting any cables and before servicing or installing equipment. • Connect only to grounded power source. • All electrical wiring must be done by a qualified electrician and comply with all local codes and regulations.

 <h1 style="margin: 0;">WARNING</h1>	
 	<p>EQUIPMENT MISUSE HAZARD</p> <p>Misuse can cause death or serious injury.</p> <ul style="list-style-type: none"> • Do not operate the unit when fatigued or under the influence of drugs or alcohol. • Do not exceed the maximum working pressure or temperature rating of the lowest rated system component. See Technical Data in all equipment manuals. • Use fluids and solvents that are compatible with equipment wetted parts. See Technical Data in all equipment manuals. Read fluid and solvent manufacturer's warnings. For complete information about your material, request the Safety Data Sheet (SDS) from distributor or retailer. • Turn off all equipment and follow the Pressure Relief Procedure when equipment is not in use. • Check equipment daily. Repair or replace worn or damaged parts immediately with genuine manufacturer's replacement parts only. • Do not alter or modify equipment. Alterations or modifications may void agency approvals and create safety hazards. • Make sure all equipment is rated and approved for the environment in which you are using it. • Use equipment only for its intended purpose. Call your distributor for information. • Route hoses and cables away from traffic areas, sharp edges, moving parts, and hot surfaces. • Do not kink or over bend hoses or use hoses to pull equipment. • Keep children and animals away from work location. • Comply with all applicable safety regulations.
	<p>TOXIC FLUID OR FUMES</p> <p>Toxic fluids or fumes can cause serious injury or death if splashed in the eyes or on the skin, inhaled, or swallowed.</p> <ul style="list-style-type: none"> • Read the Safety Data Sheet (SDS) to know the specific hazards of the fluids you are using. • Store hazardous fluid in approved containers, and dispose of it according to applicable guidelines.
 	<p>PLASTIC PARTS CLEANING SOLVENT HAZARD</p> <p>Many solvents can degrade plastic parts and cause them to fail, which could cause serious injury or property damage.</p> <ul style="list-style-type: none"> • Use only compatible water-based solvents to clean plastic structural or pressure-containing parts. • See Technical Data in this and all other equipment instruction manuals. Read fluid and solvent manufacturer's Safety Data Sheet (SDS) and recommendations.
	<p>PERSONAL PROTECTIVE EQUIPMENT</p> <p>Wear appropriate protective equipment when in the work location to help prevent serious injury, including eye injury, hearing loss, inhalation of toxic fumes, and burns. This protective equipment includes but is not limited to:</p> <ul style="list-style-type: none"> • Protective eyewear, and hearing protection. • Respirators, protective clothing, and gloves as recommended by the fluid and solvent manufacturer.

Introduction

The Pro Xpc Auto Controller is designed exclusively for controlling a Graco electrostatic spray gun as part of a paint coating system.

The controller sends power to the gun power supply, which increases the voltage to the level set at the controller. The fluid is charged by the spray gun electrode. The charged fluid is attracted to the nearest grounded object, wrapping around and evenly coating all surfaces.

Controller Features and Options

- The full voltage setting is 100 kV for solventborne guns and 60 kV for waterborne guns.
- The controller can be flush mounted at the front plate or wall mounted. See [Mounting, page 14](#).

The Pro Xpc Auto Controller provides the ability to:

- Display and set the voltage and current.
- Create and store spray presets.
- Operate the spray gun remotely via discrete I/O or Graco CAN.

The controller has three interlocks. These interlocks must be satisfied before the system will operate. Check and follow all National, State, and Local codes regarding properly interlocking your spray system. Also see [Ventilate the Spray Booth, page 13](#).

Installation

Interlocks

Interlocks are required to ensure that the system is safe to operate. The controller can use internal or external signals to receive verification that the conditions the interlocks are monitoring are in a state that is safe for the system to operate.

Xpc Auto Controller for each interlock. The table also explains how to bypass the interlock if the requirement is being satisfied in another manner.

If other forms of interlock are implemented that preclude the need to use the controller interlocks, the controller interlocks can be disabled.

Determine how the following interlocks will be used. The following table shows how to use the Pro

Interlock	Pin	Description
System Interlock	Input power cord, Pin 3 (wire 3)	<p>Pin 3 on the Input Power Connection requires line voltage to be applied for electrostatics to activate. See Step 2 in Connections, page 17.</p> <p>If not required, bypass the interlock by connecting wire 3 to line voltage on the Input Power cord. The system icon is displayed on the controller screen when the System Interlock is satisfied. See Screen Areas, page 35.</p>
24VDC Interlock	Discrete I/O cable, pin 19	<p>Pin 19 on the Discrete I/O Cable Connection requires 24VDC to be applied for electrostatics to activate. This pin can be used to connect to an external device, such as a ventilation interlock signal to the controller. Input signal values are:</p> <p>0 (0VDC or GND): Interlock not satisfied; electrostatics disabled</p> <p>1 (24VDC): interlock satisfied; electrostatics activation is not locked by this input.</p> <p>If not required, apply a constant 24VDC to Pin 19, or see Disable Controller Interlocks, page 8.</p> <p>Symbol A9 on the display screen (see Screen Areas, page 35) will show that this signal is satisfied.</p>
SAFE POSITION Interlock	Discrete I/O cable, pin 18	<p>Pin 18 on the Discrete I/O Cable Connection requires 24VDC to be applied for electrostatics to activate. Apply only when the applicator is in SAFE POSITION. See SAFE POSITION Mode, page 28. If electrostatics are on, removing 24VDC from this pin will not deactivate the electrostatics.</p> <p>0 (0VDC or GND): Interlock not satisfied; If electrostatics are off, electrostatics disabled. If electrostatics are on, no change to electrostatics.</p> <p>1 (24VDC): Interlock satisfied; electrostatics activation is not locked by this input.</p> <p>If not required, apply a constant 24VDC to Pin 18, or see Disable Controller Interlocks, page 8.</p> <p>Symbol A10 on the display screen (see Screen Areas, page 35) will show that this signal is satisfied.</p>

Disable Controller Interlocks

If interlock requirements have been satisfied in your system by means other than the Pro Xpc Auto Controller, the controller interlocks can be disabled.

1. To disable the system interlock, connect wire 3 on the controller input power cord to line voltage. The **system** icon will be lit on the display screen.
2. Remove power from the controller.
3. Remove 4 screws and take off the access cover.

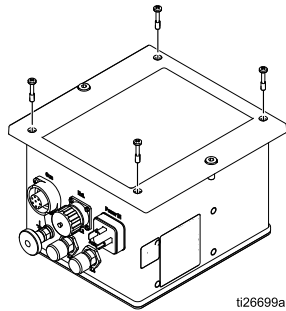

4. Locate the interlock switches on the main board. When the switches are in the ON position, the interlocks are considered satisfied.

Switch 1 is the 24VDC Interlock (pin 19 on the Discrete I/O cable). Switch 2 is the SAFE POSITION Interlock (Pin 18 on the Discrete I/O cable).

Symbols in A9 and A10 (see [Screen Areas, page 35](#)) on the display screen will show that these signals are satisfied.

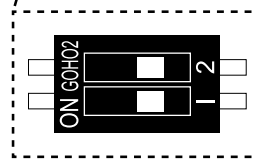
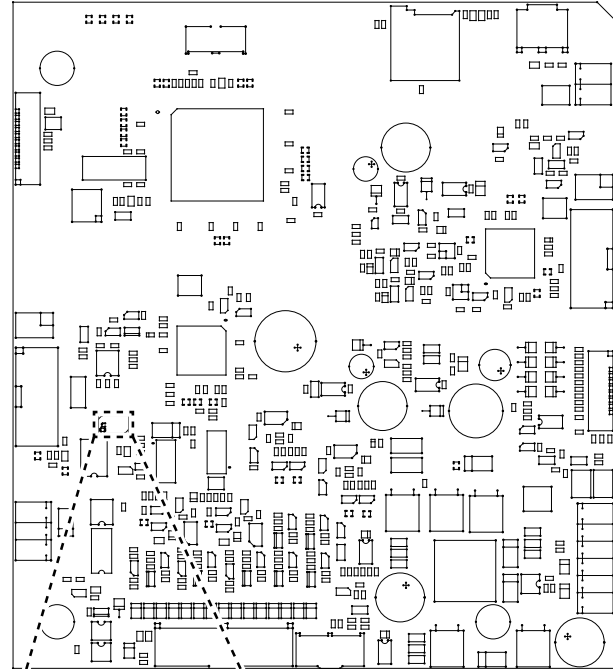



Switches shown in OFF position.

ti26788a

Installation Options

Installation details vary widely depending on the system requirements. This section shows three typical installations. They are not actual system designs. For assistance in designing a system to suit your particular needs, contact your Graco distributor.

				
<p>Installing and servicing this equipment requires access to parts which may cause fire, explosion, electric shock or other serious injury if work is not performed properly.</p> <ul style="list-style-type: none">• Do not install or service this equipment unless you are trained and qualified.• Be sure your installation complies with national, state, and local codes for the installation of electrical apparatus in a Class I, Division 1, or a Group II, Zone 1 Hazardous Location.• Comply with all applicable local, state, and national fire, electrical, and other safety regulations.				

Basic Integration

The defining characteristics of a Basic Integration installation include:

- Integration of basic gun and controller functions.
- Integration of controller interlocks.
- Local operation of setup and error functions.

This example shows a basic integration using 6, of the available 19, signals available on the Discrete I/O cable.

- **Preset Select 1 (Pin 1) and Preset Select 2 (Pin 2):** Used to select Presets P000-P003. For example: Select Preset P002 by applying 24V to Pin 2 and Ground or no connection to Pin 1.
- **Remote Enable/Disable (Pin 4):** Enable remote control through the Discrete I/O interface by applying 24V to Pin 4.

- **Electrostatic Enable (Pin 5):** Use a switched voltage source for Pin 5 to activate/trigger the electrostatics.
- **GND (Pins 8, 12, 17):** Used as ground reference for I/O signals.
- **Interlocks:** See [Interlocks, page 7](#), for information on how to set up the required interlocks.

				
To reduce the risk of fire and explosion, the controller (B) must be electrically interlocked with the spray booth ventilation fans to prevent the gun from operating without ventilation fans operating.				

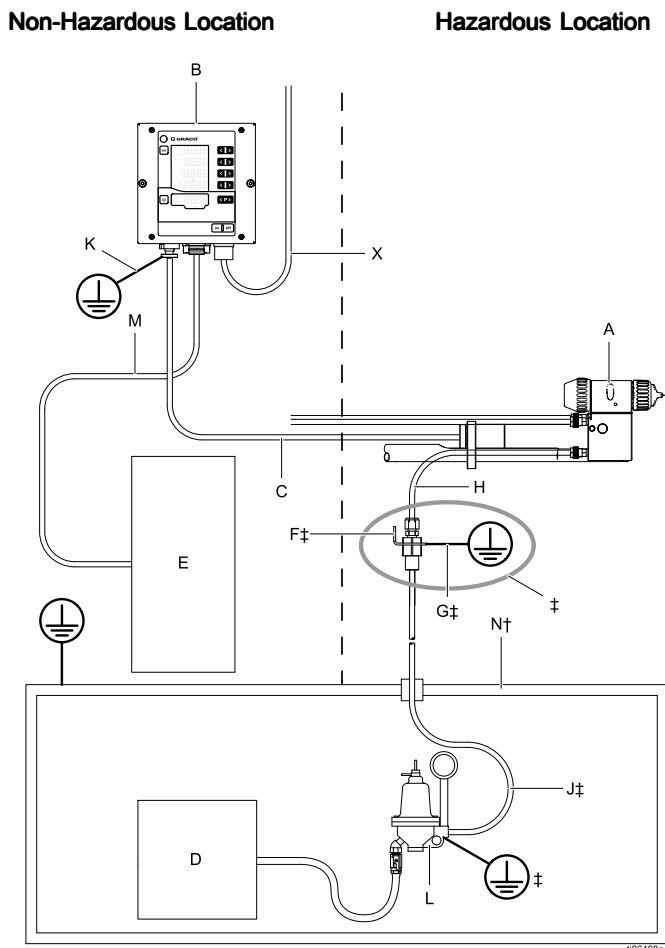

KEY:

A	Pro Xpc Auto Air Spray Gun
B	Pro Xpc Auto Controller
C	Gun Power Cable
D	Fluid Supply
E	Discrete I/O Signals
F‡	Fluid Hose Ground Bracket
G‡	Fluid Bracket Ground Wire
H	‡Fluid Supply Tube (Graco-supplied) to gun fluid inlet, maximum 8 ft (2.4 m) length †Graco Waterborne Fluid Supply Hose, from fluid regulator (L) to gun inlet (hose must be a single, uninterrupted length).
J‡	Fluid Supply Hose
K	Pro Xpc Auto Controller Ground Wire
L	Fluid Regulator
M	Discrete I/O Cable
N†	Isolation Enclosure
X	Pro Xpc Auto Controller Power Cord

†Waterborne systems only
‡Solventborne systems only

Typical Installation With Basic Integration

PLC Integration

The defining characteristics of a PLC (Programmable Logic Controller) Integration installation include:

- PLC integration of all gun and controller functions.

See [Discrete I/O, page 19](#), for a complete description of the signals.

				
To reduce the risk of fire and explosion, the controller (B) must be electrically interlocked with the spray booth ventilation fans to prevent the gun from operating without ventilation fans operating.				

Non-Hazardous Location

Hazardous Location

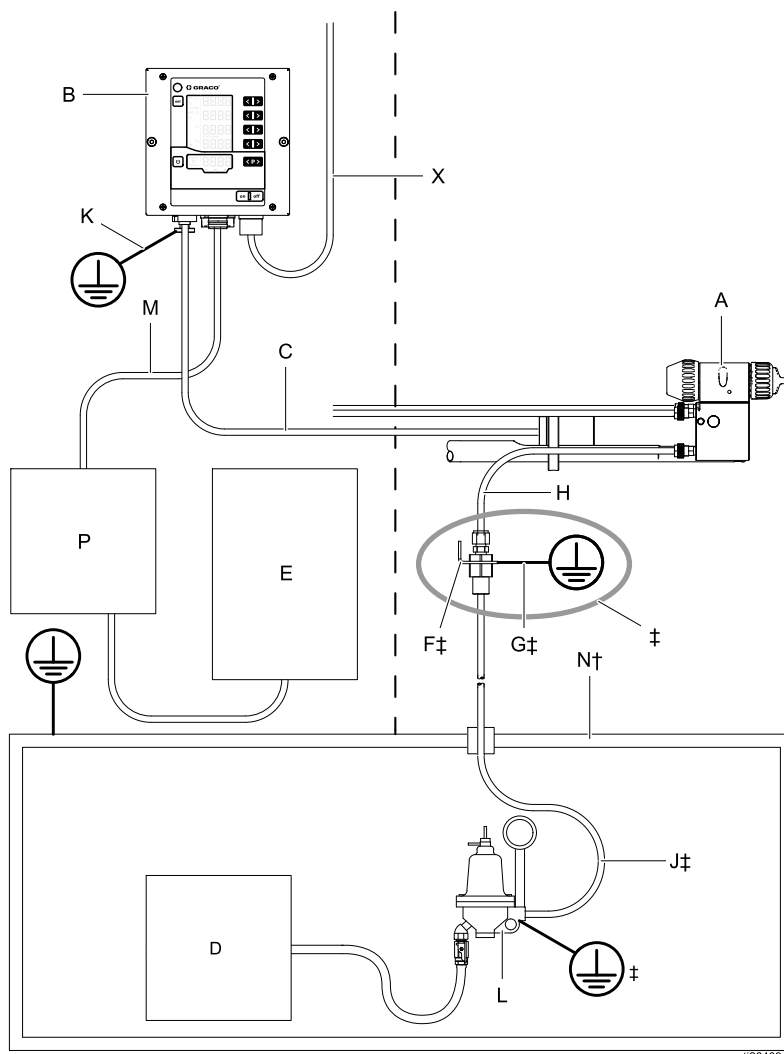

Typical Installation With PLC Integration

KEY:

A	Pro Xpc Auto Air Spray Gun
B	Pro Xpc Auto Controller
C	Gun Power Cable
D	Fluid Supply
E	Robot or Reciprocator
F‡	Fluid Hose Ground Bracket
G‡	Fluid Bracket Ground Wire
H	‡Fluid Supply Tube (Graco-supplied) to gun fluid inlet, maximum 8 ft (2.4 m) length †Graco Waterborne Fluid Supply Hose, from fluid regulator (L) to gun inlet (hose must be a single, uninterrupted length).
J‡	Fluid Supply Hose
K	Pro Xpc Auto Controller Ground Wire
L	Fluid Regulator
M	Discrete I/O Cable
N†	Isolation Enclosure
P	PLC
X	Pro Xpc Auto Controller Power Cord

†Waterborne systems only
‡Solventborne systems only

Pre-Installation Steps

Ventilate the Spray Booth

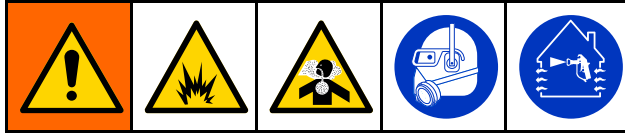

Provide fresh air ventilation to avoid the buildup of flammable or toxic vapors when spraying, flushing, or cleaning the gun. Do not operate the gun unless ventilation fans are operating.

Electrically interlock the controller (B) with the ventilators to prevent gun operation without ventilating fans operating. Use the 24 VDC Interlock pin on the Discrete I/O cable to connect to the ventilator interlock. Check and follow all National, State, and Local codes regarding air exhaust velocity requirements.

NOTE: High velocity air exhaust will decrease the operating efficiency of the electrostatic system. The minimum allowable air exhaust velocity is 60 ft/minute (19 linear meters/minute).

Install the Pro Xpc Auto Spray Gun

See the Pro Xpc Auto Air Spray Gun Manual (332992) for installation instructions.

Interlock Waterborne Isolation Enclosure

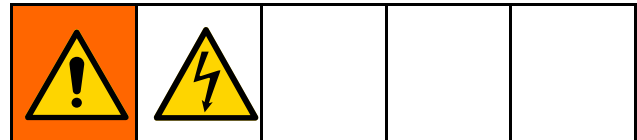

To reduce the risk of electric shock, interlock the controller with the voltage isolation system to shut off the electrostatics anytime the isolation system enclosure is opened.

For information about the interlocks and their use, see [Interlocks, page 7](#).

Mount the Controller

				
To reduce the risk of fire or explosion, do not install equipment approved only for a non-hazardous location in a hazardous location.				

Location

Install the Pro Xpc Auto Controller in a non-hazardous location only.

Mounting

The Pro Xpc Auto Controller can be flush mounted at the front plate or wall mounted.

Wall Mount (Flat Panel)

An optional method of mounting the controller is to use a panel with a cutout and mounting holes.

1. See [Dimensions, page 64](#).
2. Determine the mounting location. Ensure that the location will support the mounting panel and the controller.
3. Prepare the panel by cutting out the opening and preparing the mounting holes for the controller:
 - a. If the two controller front panel screws are to be used to attach the controller to the panel, the panel holes will require tapping threads, or providing some other sort of threaded fastener, such as PEM nuts on the panel.
 - b. If an alternative fastener will be used, it may be necessary to back out the two threaded fasteners from the controller front cover so that the mounting hardware can use the existing controller front panel mounting holes.



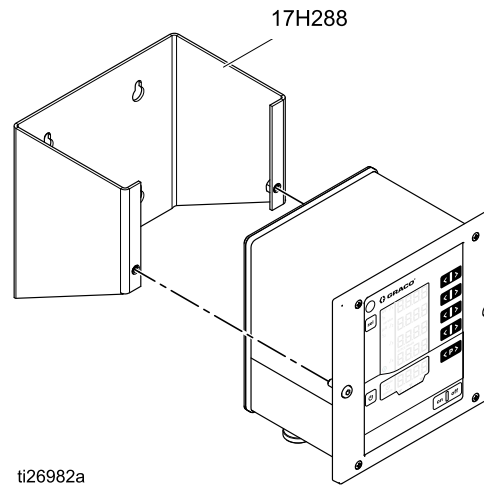

Wall Mount (Mounting Bracket)

An optional wall mount bracket (17H288) is available to mount the controller on any flat wall.

1. See [Dimensions, page 64](#).
2. Determine mounting location. Ensure that the wall is strong enough to support the weight of the mounting bracket and the controller.
3. Position the mounting bracket on the wall and mark mounting holes using the plate of the bracket as a template.
4. Drill holes and attach the mounting bracket to the wall.
5. Attach the controller to the wall mount bracket using two 6 mm screws (provided).



Grounding

				
<p>When operating the electrostatic gun, any ungrounded objects in the spray location (people, containers, tools, etc.) can become electrically charged. Improper grounding can result in static sparking, which can cause a fire, explosion, or electric shock. Ground all equipment, personnel, object being sprayed, and conductive objects in or close to the spray location. Follow the grounding instructions below.</p>				

The following are minimum grounding requirements for a basic electrostatic system. Your system may include other equipment or objects which must be grounded. Check your local electrical code for detailed grounding instructions. Your system must be connected to a true earth ground.

- *Pro Xpc Auto Controller*: Ground the Pro Xpc Auto Controller with a grounded power cord and grounded socket. Also ground the controller with the ground connection and ground wire.
- *Pump*: ground the pump by connecting a ground wire and clamp as described in your separate pump instruction manual.
- *Fluid Bracket (for solventborne systems only)*: ground the fluid bracket by connecting the bracket ground wire to a true earth ground. Mount the fluid bracket a distance behind the gun that can be reached by a hose with a maximum length of 8 ft (2.4 m).
- *Fluid Tube (for solventborne systems only)*: ground the fluid tube by connecting it to the grounded fluid bracket.
- *Fluid Hose (for waterborne systems only)*: the hose is grounded through the conductive layer. Install the hose as instructed in the gun manual.
- *Electrostatic Air Spray Gun*: ground the gun by connecting the gun power cable to a properly grounded controller.
- *Air compressors and hydraulic power supplies*: ground the equipment according to the manufacturer's recommendations.
- *All electrical cables* must be properly grounded.
- *All persons entering the spray location*: shoes must have conductive soles, such as leather; or personal grounding straps must be worn. Do not wear shoes with non-conductive soles such as rubber or plastic.
- *Object being sprayed*: keep the workpiece hangers clean and grounded at all times. Resistance must not exceed 1 megohm.
- *The floor of the spray location*: must be electrically conductive and grounded. Do not cover the floor with cardboard or any non-conductive material which would interrupt ground continuity.
- *Flammable liquids in the spray location*: must be kept in approved, grounded containers. Do not use plastic containers. Do not store more than the quantity needed for one shift.
- *All electrically conductive objects or devices in the spray location*: including fluid containers and wash cans, must be properly grounded.

Controller Connections

Overview

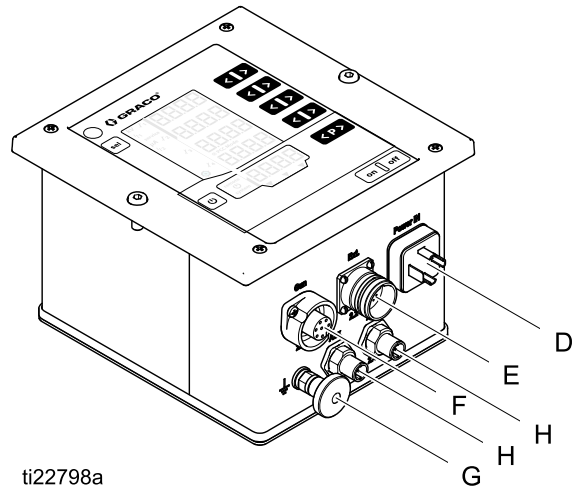
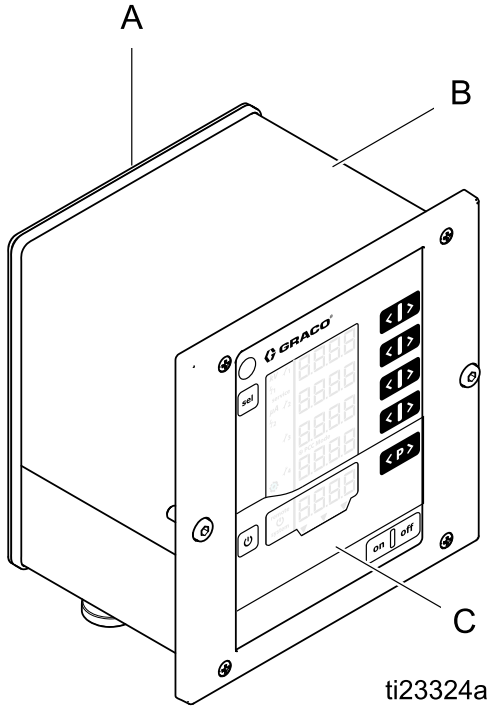

A	Back panel
B	Enclosure
C	Front Plate with control and display elements

D	Input Power Connection
E	Discrete I/O Cable Connection — use in a system that requires integration
F	Gun Power Cable Connection
G	Ground Connection
H	CAN Connection

Connections

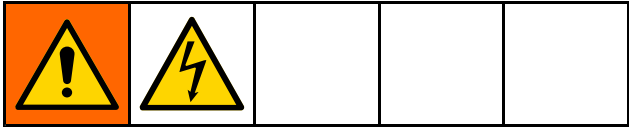

1. Connect the ground wire to the ground connection (G). Connect the other end to a true earth ground. This connection is required for all installations.
2. Connect the supplied controller input power cord to the input power connection (D) and secure with

the connector screw. This connection is required for all installations. The controller can operate at 100–240 VAC (50–60 Hz). Connect the leads to a power source according to local electrical codes. Pin 3 on the input power connection is the system interlock. Pin 3 must have line voltage applied to satisfy the system interlock. When the system interlock pin is connected to line voltage, the **system** icon will appear on the controller. See [Screen Areas, page 35](#).

Controller Input Power Connection		Pin No.	Function	Wire Marking
<p>Controller</p>	<p>Power Cord</p>	1	Neutral conductor power supply	1
		2	Phase (100-240 VAC)	2
		3	System Interlock ON/OFF (100-240 VAC) = ON	3
		PE	Grounding PE	Green/Yellow

3. Connect the 7-pin end of the gun power cable to the gun power cable connection (F) on the controller. Connect the 4-pin end of the gun power cable to the spray gun. Follow instructions

in the gun manual. This connection is required for all installations.

Controller		Gun	
Connector (F)	Cable	Cable	Power Supply Connector

Electrical Schematic for this cable:

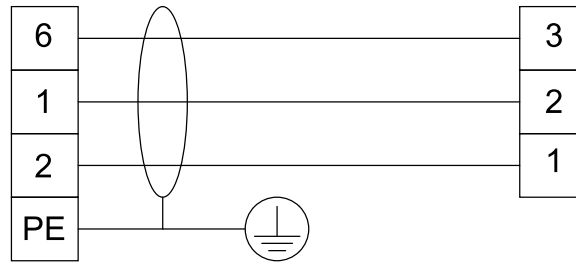

NOTE: Connector pins not shown are not connected to a wire in the cable.

Controller Connections

- Connect the Discrete I/O cable to the Discrete I/O cable connection (E) on the controller. The Discrete I/O cable is required for any installation that involves integration. Two discrete I/O interlock connections are supplied and must be satisfied. (See [Interlocks, page 7](#)) See [Discrete I/O, page 19](#) for a more detailed explanation of each pin.

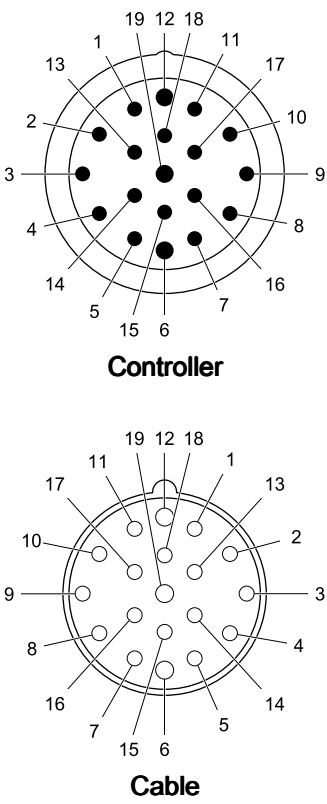
Discrete I/O cable Connection			
 <p>Controller</p> <p>Cable</p>	Pin No.	Function	Wire Color
	1	Preset Select 1	White
	2	Preset Select 2	Brown
	3	Error Reset	Green
	4	Remote Enable/Disable	Yellow
	5	Electrostatics Enable	Gray
	6	Safe-to-Move Output	Pink
	7	Error Output	Blue
	8	I/O Ground	Red
	9	Current Setpoint Input	Black
	10	Voltage Setpoint Input	Purple
	11	Reserved Input	Gray/Pink
	12	I/O Ground	Red/Blue
	13	Actual Spraying Current Output	White/Green
	14	Actual Spraying Voltage Output	Brown/Green
	15	Electrostatic Discharge	White/Yellow
	16	Analog Output External Power (24 VDC)	Yellow/Brown
	17	I/O Ground	White/Gray
	18	SAFE POSITION Interlock Input	Gray/Brown
19	24VDC Interlock Input	Pink/Brown and Pink/White	

See [Discrete I/O, page 19](#) for more information.

- Connect the Graco CAN cables to the CAN cable connections (H) on the controller. CAN communication is required for remote operation with Graco modules to allow remote configuration and operation of the controller.

NOTE: CAN communication is Graco proprietary and will not work with other types of CAN.

Discrete I/O

The controller can accept up to 19 I/O interface signals. Systems can be designed to integrate from 1 signal up to all 19 signals. The examples in this manual describe a basic integration (6 I/O signals used) and a complex integration (all 19 I/O signals used).

Discrete I/O input signals are only monitored if the Pro Xpc Auto Controller has been placed in the Discrete I/O mode. See [Setup Screen 2 \(Remote Interface\)](#), page 41.

See [Signals](#), page 20 for available signals.

Isolation

The discrete I/O interface signals are isolated from circuit ground. Isolation is required to prevent disturbance of the measurement of the spraying current.

NOTE: The isolation is not designed to isolate hazardous potentials.

I/O Grounding

Pins 8, 12, and 17 are the I/O Ground pins. Connect a ground from each connecting device to one or more of these pins. This will match the potential of the Pro Xpc Auto Controller and the connecting device.

REMOTE Input Operation

In order to accept remote input commands from the discrete I/O interface, the following conditions must be met:

- The discrete I/O interface must be selected by setting Parameter P02 = 1. See [Setup Screen 2 \(Remote Interface\)](#), page 41.
- The REMOTE Enable input, on the Discrete I/O cable, pin 4, must have 24VDC (logical "1") applied to it to select REMOTE mode.

Connect the desired input signals. During REMOTE input operation, error confirmation is the only local input (using the keypad) possible.

NOTE: Values for presets P001 – P003 must be set up prior to entering REMOTE mode. Preset P000 is the only preset which can be altered using the Discrete I/O cable signals when the controller has been placed in REMOTE mode. Presets P004 - P250 are not accessible in REMOTE mode.

REMOTE Output Operation

Connect the desired signals. Digital output signals are generated unconditionally. Analog output signals require 24VDC on Analog Output External Power (pin 16) on the discrete I/O Interface cable.

Signals

Note on Digital Inputs and Outputs: A “0 (or Low)” is used to indicate that GND or no signal is present. A “1 (or High)” is used to indicate that a 24 VDC signal is present.

Pin	Type	Description															
1	Digital Input	<p>Preset Select 1 (Pin 1) and Preset Select 2 (Pin 2)</p> <p>Use to specify the Preset selection in REMOTE operation through the discrete I/O interface:</p> <table border="1"> <thead> <tr> <th>Pin 2</th> <th>Pin 1</th> <th></th> </tr> </thead> <tbody> <tr> <td>0</td> <td>0</td> <td>Preset P000</td> </tr> <tr> <td>0</td> <td>1</td> <td>Preset P001</td> </tr> <tr> <td>1</td> <td>0</td> <td>Preset P002</td> </tr> <tr> <td>1</td> <td>1</td> <td>Preset P003</td> </tr> </tbody> </table> <p>In REMOTE mode, the values for Preset P000 are based on the analog signals received on the discrete I/O interface. These values will overwrite any existing values in Preset P000.</p> <p>The values for Presets P001–P003 must be entered locally, using the keypad, prior to placing the controller in REMOTE mode. It is not possible to change the values of these Presets remotely.</p> <p>Presets P004–P250 are not accessible in REMOTE mode.</p>	Pin 2	Pin 1		0	0	Preset P000	0	1	Preset P001	1	0	Preset P002	1	1	Preset P003
Pin 2	Pin 1																
0	0	Preset P000															
0	1	Preset P001															
1	0	Preset P002															
1	1	Preset P003															
2	Digital Input																
3	Digital Input	<p>Error Reset</p> <p>Use to allow error codes to be acknowledged remotely. Acknowledging an error code does not correct the condition that created the error.</p> <p>0→1 transition: Reset all reported errors</p> <p>NOTE: Additional errors will be logged, regardless of the state of the Error reset. To perform additional error resets, transition from 0 to 1 again.</p>															
4	Digital Input	<p>REMOTE Enable/Disable</p> <p>Use to enable or disable REMOTE operation. Enabling REMOTE operation locks out local control and allows the controller to use the discrete I/O interface. When enabled, the remote icon on the display is shown.</p> <p>0: Local control 1: REMOTE control</p>															
5	Digital Input	<p>Electrostatic Enable</p> <p>Use to enable or disable electrostatics output.</p> <p>0: Disable electrostatics. 1: Enable electrostatics. All other conditions for activating the electrostatics must be met.</p>															

Pin	Type	Description
6	Digital Output	<p>Safe-to-Move Output</p> <p>Indicates whether the applicator can be moved out of SAFE POSITION to begin paint application. This output is tied to the arc detection blanking time setting on <i>Setup Screen 9</i>. The blanking timer begins counting down when high voltage is enabled. When the timer has reached zero, the Safe-to-Move Output is switched from 0 to 1.</p> <p>0: Applicator must not be moved out of SAFE POSITION because arc detection is blanked and electrostatics are activated.</p> <p>1: Applicator allowed to be moved out of SAFE POSITION because arc detection is effective or electrostatics are deactivated.</p> <p>For more information, see SAFE POSITION Mode, page 28.</p>
7	Digital Output	<p>Error Output</p> <p>Used to signal detection of an error condition.</p> <p>0: No error condition detected.</p> <p>1: An error condition has been detected and reported.</p> <p>NOTE: Reset by Error Reset input or by local confirmation.</p>
8	Ground	<p>I/O Ground</p> <p>Reference potential for I/O interface signals.</p>
9	Analog Input	<p>Current Setpoint Input</p> <p>Use to set the current setpoint (μA) nominal value. The REMOTE current setpoint input applies when Preset 0 (P000) is selected and the controller is in REMOTE operation.</p> <p>This signal is used to create the current setting in P000. The larger the input value, the greater the electrostatics current setpoint.</p> <p>0 – 10 V (received input) \rightarrow 0 – 150 μA (desired gun output)</p> <p>OR</p> <p>4 – 20 mA (received input) \rightarrow 0 – 150 μA (desired gun output)</p> <p>The type of input is selected on Setup Screen 3 (Analog Input Type Select), page 42</p>
10	Analog Input	<p>Voltage Setpoint Input</p> <p>Use to set the voltage setpoint (kV) nominal value. The REMOTE voltage setpoint input applies when Preset 0 (P000) is selected and the controller is in REMOTE operation.</p> <p>The input voltage or current is used to create a relational output voltage value for the gun electrostatics power supply. The larger the input value, the greater the electrostatics voltage at the gun.</p> <p>0 – 10V (received input) \rightarrow 0 – <i>max kV*</i> (desired gun output)</p> <p>OR</p> <p>4 – 20mA (received input) \rightarrow 0 – <i>max kV*</i> (desired gun output)</p> <p>The type of input is selected on Setup Screen 3 (Analog Input Type Select), page 42</p> <p>* <i>max kV</i> = 100 kV (solventborne) or 60 kV (waterborne)</p>
11	Digital Input	Reserved for future use.

Pin	Type	Description
12	Ground	I/O Ground Reference potential for discrete I/O interface signals.
13	Analog Output	Actual Spraying Current Output Use to indicate the actual spraying current (0 – 150 μ A). 24 VDC must be applied to Pin 16 to enable this function. The voltage or current signal present on this pin is proportional to the spraying current of the electrostatic power supply. The larger the value on this pin, the greater the output current at the gun. 0 – 150 μ A (gun output) \rightarrow 0 – 10V or 4 – 20 mA (pin output) The type of output is selected on Setup Screen 4 (Analog Output Type Select) , page 42
14	Analog Output	Actual Spraying Voltage Output Use to indicate the actual spraying voltage (0– <i>max kV</i> *). 24 VDC must be applied to Pin 16 to enable this function. The voltage or current signal present on this pin is proportional to the spraying voltage of the electrostatic power supply. The larger the value on this pin, the greater the output voltage at the gun. 0 – <i>max kV</i> * (gun output) \rightarrow 0 – 10V or 4 – 20 mA (pin output) The type of output is selected on Setup Screen 4 (Analog Output Type Select) , page 42 * <i>max kV</i> = 100 kV (solventborne) or 60 kV (waterborne)
15	Digital Output	Electrostatic Discharge Output Use to indicate when electrostatics have been fully discharged. Set the electrostatic discharge time setting on <i>Setup Screen 10</i> (Configuration C2). The discharge timer begins counting down when electrostatics have been disabled. When the timer reaches zero, the Electrostatic Discharge Output is switched from low (0) to high (1). 0: Electrostatic voltage not discharged 1: Electrostatic voltage discharge time has elapsed.
16	Analog Output External Power	Analog Output External Power (24VDC) Apply power (24 VDC / 100 mA) to this pin to power the analog output circuitry. This voltage is to be supplied externally, i.e., from PLC. Can be omitted if the analog outputs are not required.
17	Ground	I/O Ground Reference potential for discrete I/O interface signals.

Pin	Type	Description
18	Digital Input	<p>SAFE POSITION Interlock Input</p> <p>The controller will not activate the electrostatics unless this and all other interlock inputs have been satisfied. If satisfied in another manner, this interlock can be disabled by changing switch 2 to the ON position on the controller main circuit board. See Disable Controller Interlocks, page 8 .</p> <p>The SAFE POSITION interlock does not deactivate electrostatics when the signal is not satisfied. This signal indicates that a robot or applicator is in a position in which it is safe to activate electrostatics without arc detection.</p> <p>0: Interlock not satisfied: If electrostatics are off, electrostatics disabled. If electrostatics are on, no change to electrostatics.</p> <p>1: Interlock satisfied; electrostatics activation is not locked by this input.</p> <p>NOTE: Switching from 1 to 0 does not deactivate electrostatics.</p> <p>Symbol A10 on the display screen (see Screen Areas, page 35) will show that this signal is satisfied.</p>
19	Digital Input	<p>24VDC Interlock Input</p> <p>The controller will not activate electrostatics unless this and all other interlock inputs have been satisfied. If satisfied in another manner, this interlock can be disabled by changing switch 1 to the ON position on the controller main circuit board. See Disable Controller Interlocks, page 8 .</p> <p>0: Interlock not satisfied; electrostatics disabled</p> <p>1: Interlock satisfied; electrostatics activation is not locked by this input.</p> <p>Symbol A9 on the display screen (see Screen Areas, page 35) will show that this signal is satisfied.</p>

Analog Inputs

The analog inputs are used to set certain parameters remotely by a PLC. The inputs can be configured to be either voltage or current inputs. This setting applies to all inputs simultaneously.

Electrical Specifications

Use Parameter P03 (See [Setup Screen 3 \(Analog Input Type Select\)](#), page 42) to select the input signal type.

Voltage input mode, P03 = 0

Parameter	Value
Nominal input range	0 – 10 VDC
Input impedance	4.7 kΩ
Maximum allowed input voltage	30 VDC
Reverse polarity protection	Yes
Accuracy	1% typical
Recommended source impedance	< 10 Ω

Current input mode, P03 = 1

Parameter	Value
Nominal input range	4 – 20 mA (sinking)
Input impedance	100 Ω
Maximum allowed input voltage	30 V
Reverse polarity protection	Yes
Input current limit	Yes, 25 mA
Accuracy	1% typical

Analog Outputs

The analog outputs are used to communicate actual values to other devices, such as a PLC. The outputs can be configured to be either voltage or current outputs. This setting applies to all outputs simultaneously. The analog outputs require an external 24VDC voltage to be connected to Analog Output External Power (discrete I/O interface, pin 16).

Electrical Specifications

Use Parameter P04 (See [Setup Screen 4 \(Analog Output Type Select\)](#), page 42) to select the output signal type.

Voltage output mode, P04 = 0

Parameter	Value
Output voltage range	0 – 10 VDC
Output impedance	< 10 Ω (sourcing)
Short circuit protection	0 – 30 VDC
Accuracy	1% typical

Current output mode, P04 = 1

Parameter	Value
Output current range	4 – 20 mA
Output impedance	< 10 Ω (sourcing)
Short circuit protection	0 – 30 V
Accuracy	1% typical
Maximum load resistance	1 kΩ (0–20 VDC)
Minimum load resistance	0 Ω (0–20 VDC)

Digital Inputs

Electrical Specification

Parameter	Value
Input type	Current sinking
Input impedance	>10 kΩ
Maximum allowed input voltage	30 VDC
Minimum required "1" input voltage	> 10 VDC
Maximum allowed "0" input voltage	< 4 V (Open inputs have "0" level)

Digital Outputs

The digital outputs provide status signals to other devices, such as a PLC.

NOTE: Digital outputs require a pullup to the connecting device's logic level "1" (e.g., 24VDC).

Electrical Specification

Parameter	Value
Output type	NPN Open Collector, sinking
Output impedance	1.8 kΩ
Maximum allowed output voltage	30VDC
Short circuit protection	0 – 30VDC

Discrete I/O Interface Connections

The electrical connections for the Discrete I/O interface pins are shown here.

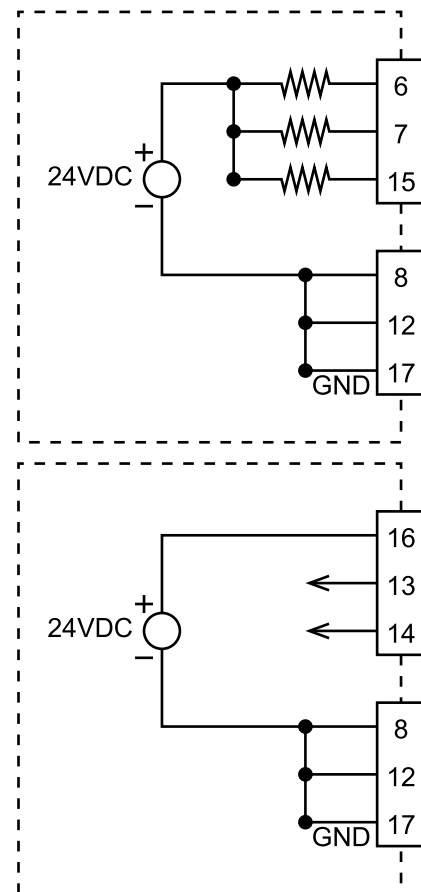
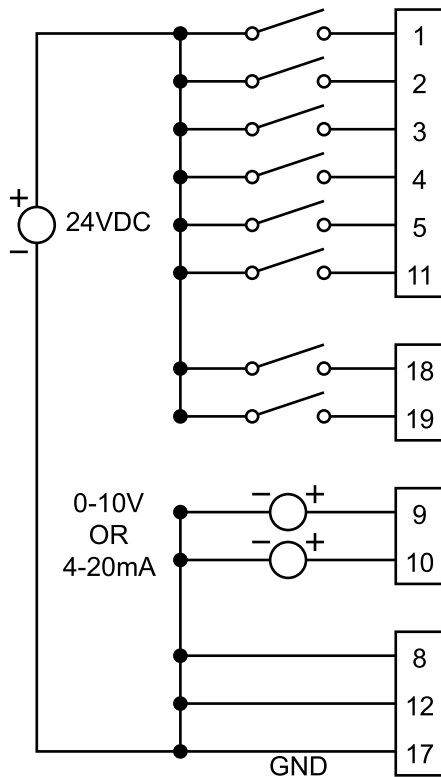





Operation Modes and Timing Diagrams

The system control logic is responsible for turning the electrostatics on and off. The spray system has several modes of operation. These modes describe the system state, but are not selectable by the user. It is important that these are understood for proper integration and safety.

The operation modes are:

- Standby: Electrostatics held in off mode
- SAFE POSITION: Verify the applicator position before enabling the electrostatics
- Spray: Fluid and electrostatics enabled, applicator in motion
- Error handling
- Purge: Flush solvent is present, no electrostatics, applicator not in motion

				
<p>To avoid fire, explosion, and electric shock, always turn the electrostatics off when flushing, cleaning, or servicing equipment. Always ground equipment and waste container.</p> <p>This can be accomplished by using one of the interlock inputs or through control of the Electrostatic Enable pin. This can also be accomplished by powering down the controller.</p>				

Standby Mode

The standby mode is when the electrostatics are off because the system is not ready to perform a spraying operation. During the standby mode, the following conditions may exist:

- The system is powered down
- Fluid is being loaded

The controller will deactivate the electrostatics (if electrostatics are activated), or will prevent the electrostatics from being activated, when any or a combination of the following signals go low:

- System interlock (power connector)
- 24VDC Interlock
- Electrostatic Enable

NOTE: The SAFE POSITION input will not deactivate electrostatics if they are already on. The SAFE POSITION input will only prevent electrostatics from being activated.

All input signals shown here must be high for the controller to enable electrostatics.

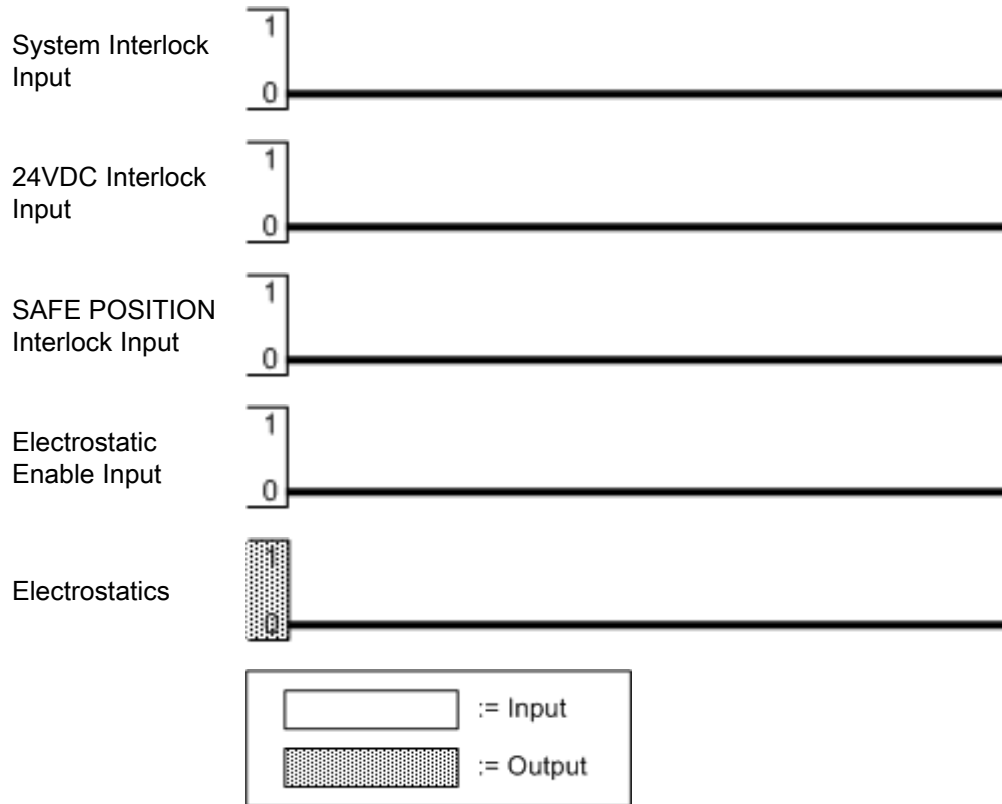

SAFE POSITION Mode

The SAFE POSITION is defined as a position where the gun electrode is at least 8 inches away from any grounded object. While many such positions may exist, one position should be selected as the applicator SAFE POSITION. When the applicator is in the SAFE POSITION, electrostatics can be activated, blanking time allowed to elapse, and arc detection activated. The applicator should remain in the SAFE POSITION until the system reaches full voltage and arc detection is active.

To enable electrostatics using SAFE POSITION:

1. Satisfy the System and 24VDC interlocks.
2. If controlling the system through the discrete I/O interface, set the REMOTE input high.
3. Move the applicator to SAFE POSITION. Then set the SAFE POSITION interlock high to tell the Pro Xpc Auto controller that the applicator is in SAFE POSITION and that the electrostatics can be activated.
4. Set the Electrostatic Enable input high or activate the electrostatics..
5. The Pro Xpc Auto controller activates the electrostatics at the gun.
6. The Safe-to-Move output is set high when the time defined by the arc detection blanking parameter (C1) value, as defined on [Setup Screen 11 \(Transition Time\), page 45](#) has elapsed after receiving the Electrostatic Enable input high signal. The Safe-to-Move signal indicates that the controller has determined that the gun electrostatics are ready for application and that the applicator can move freely. Arc detection is deactivated during the blanking time. The C1 setting defines the length of time before arc detection is enabled.

When the applicator leaves the SAFE POSITION, the SAFE POSITION Interlock is removed, which leaves it not satisfied. This does not disable the electrostatics. If the electrostatics are deactivated, the robot needs to return to the SAFE POSITION and reapply the SAFE POSITION Interlock input in order to activate the electrostatics.

SAFE POSITION Timing Diagram

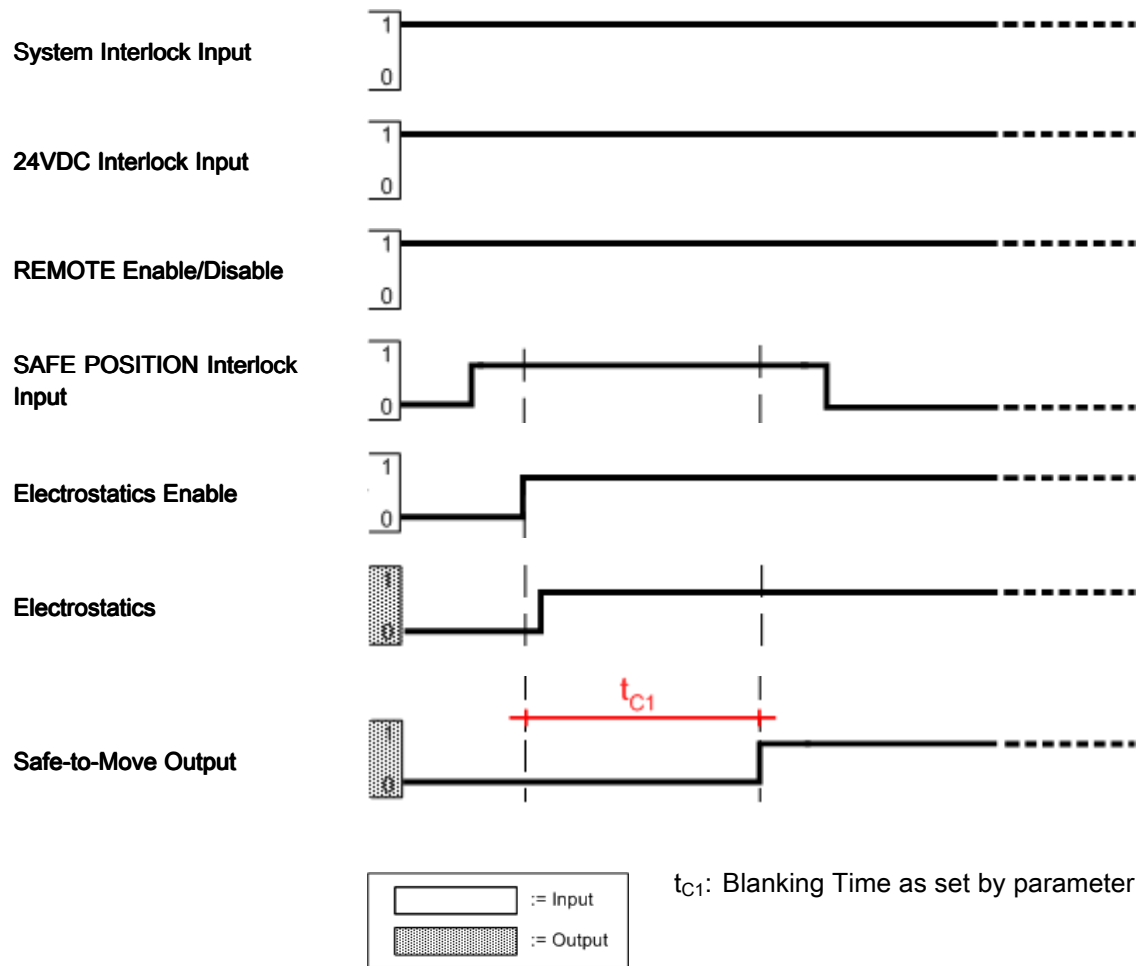

Spray

The system is in spray mode when the applicator is ready to leave SAFE POSITION or is in motion and electrostatics are enabled.

To start spraying:

1. Satisfy all interlocks (shown as “All Interlocks”)
2. If spraying using the Discrete I/O interface, enable REMOTE operation using the Remote Enable/Disable input.
3. Set the desired voltage and current:
 - a. If spraying in local mode using the Pro Xpc Auto Controller interface, select the active Preset (P000-P003) using the **<P>** keys. Set the voltage and current setpoints using the **◀** and **▶** keys (see [Run Screen 1 \(Electrostatics Readings\)](#), page 47).
 - b. If using the discrete I/O interface, select the active Preset (P000-P003) using Preset Select 1 and Preset Select 2. If analog control is desired, select Preset P000. Use the Current Setpoint Input and Voltage Setpoint input to adjust the electrostatics.
 - c. If using the CAN interface, select the active Preset or select the desired voltage and current.
4. Activate the electrostatics. If spraying in local mode using the Pro Xpc Controller interface, activate the electrostatics using the **⏻** key. If using the discrete I/O interface, activate the electrostatics using the Electrostatic Enable Input.
5. If spraying in REMOTE mode, monitor the Safe-to-Move Output to know when the blanking time has passed and arc detection is enabled. The blanking time is defined by Parameter C1 (see [Setup Screen 9 \(Blanking Time\)](#), page 44).
6. Change the desired electrostatic output:
 - a. If spraying in local mode using the Pro Xpc Auto Controller interface, change the active Preset (P000-P003) using the **<P>** keys. Set the voltage and current setpoints using the **◀** and **▶** keys (see [Run Screen 1 \(Electrostatics Readings\)](#), page 47).
 - b. If using the discrete I/O interface, change the active Preset (P000-P003) using Preset Select 1 and Preset Select 2. If analog control is desired, select Preset P000. Use the Current Setpoint Input and Voltage Setpoint input to adjust the electrostatics.
 - c. If using the CAN interface, change the active preset or change the desired voltage and current.

The electrostatics will transition to the desired output over the transition time. This time is set by Parameter C3 (see [Setup Screen 11 \(Transition Time\)](#), page 45). The transition time is not used during activation (0 to setpoint) or deactivation (setpoint to 0).
7. Disable the electrostatics when done spraying. If spraying in local mode using the Pro Xpc Controller interface, deactivate the electrostatics using the **⏻** key. If using the discrete I/O interface, deactivate the electrostatics using the Electrostatics Enable Input.
8. If spraying in REMOTE mode, monitor the Electrostatic Discharge Output to know when the discharge time has passed and the system is fully discharged. The discharge time is defined by Parameter C2 (see [Setup Screen 10 \(Discharge Time\)](#), page 45).

The diagram below shows discrete I/O REMOTE mode and shows three parts of electrostatic spraying: activate, setpoint change, and deactivate. Blanking time t_{C1} , transition time t_{C2} , and discharge time t_{C3} are also illustrated.

Spray Timing Diagram

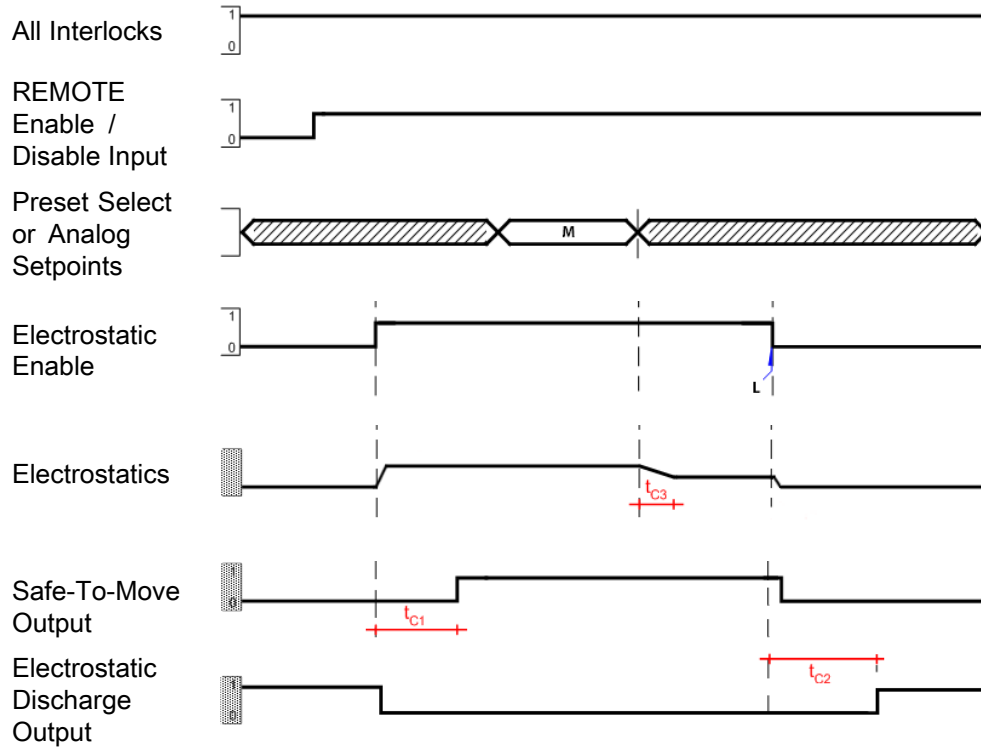

L – Any method used to disable electrostatics
M – Setting Change
 t_{c1} – Blanking Time as set by parameter C1
 t_{c2} – Discharge Time as set by parameter C2
 t_{c3} – Transition time as set by parameter C3

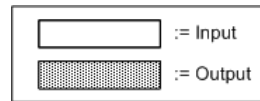

Error Handling

The system is in error handling mode when an error occurs that disables electrostatics. When an error occurs, an error code is generated. This error code is shown in red on the Pro Xpc Auto Controller user interface in location A5 and Discrete I/O Error Output signal is high.

Handle an error with the following procedure:

1. Fix the condition that caused the error code (see [Troubleshooting, page 55](#)).
2. Acknowledge the error code:
 - a. If using the discrete I/O interface, acknowledge the error code using Discrete I/O Error Reset, (Pin 3).
 - b. If in local mode, acknowledge the error code using the **<P>** button (T11) on the Pro Xpc Auto controller user interface.

3. Move the robot to SAFE POSITION. Satisfy the SAFE POSITION interlock.
4. Activate the electrostatics.
5. The Blanking Time passes; Safe-to-Move output is set high.

The diagram shows an example of error handling using the discrete I/O interface.

Error Handling Timing Diagram

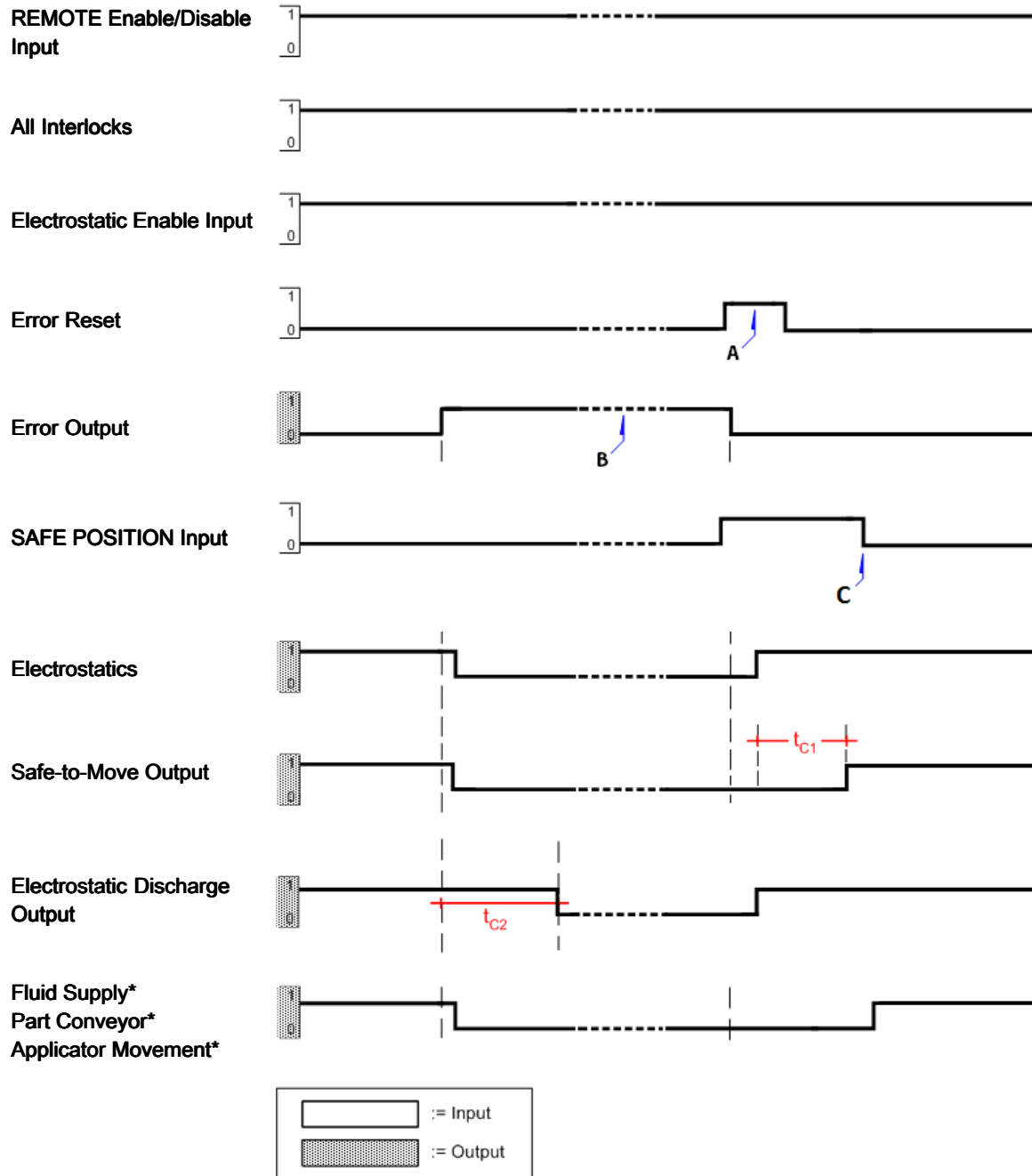

A: Hold high until error output is low

B: Fix error condition

C: Robot has begun movement from SAFE POSITION after Safe-to-Move

t_{c1} : Blanking Time as set by parameter t_{c1}

t_{c2} : Discharge Time as set by parameter t_{c2}

* Not controlled by electrostatic controller

Purge

During Purge mode flush solvent is present, electrostatics are disabled, and the applicator is not in motion.

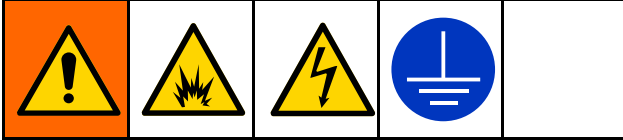

To avoid fire, explosion, and electric shock, always turn the electrostatics off when flushing, cleaning, or servicing equipment. Always ground equipment and waste container.

This can be accomplished by using one of the interlock inputs or through control of the Electrostatic Enable pin. This can also be accomplished by powering down the controller.

Disable the electrostatics any time the solvent supply is activated. Before enabling electrostatics again, ensure that the fluid lines are completely free of solvent. Determine any time and volume requirements for paint to be loaded. Ensure that the electrostatics are disabled for the entire load sequence.

Deactivate the electrostatics using one or combination of the following signals:

- System Power Interlock: Low
- 24VDC Interlock: Low
- Electrostatic Enable Input: Low
- Powering off the Pro Xpc Auto Controller by pressing the **off** button.

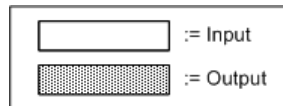
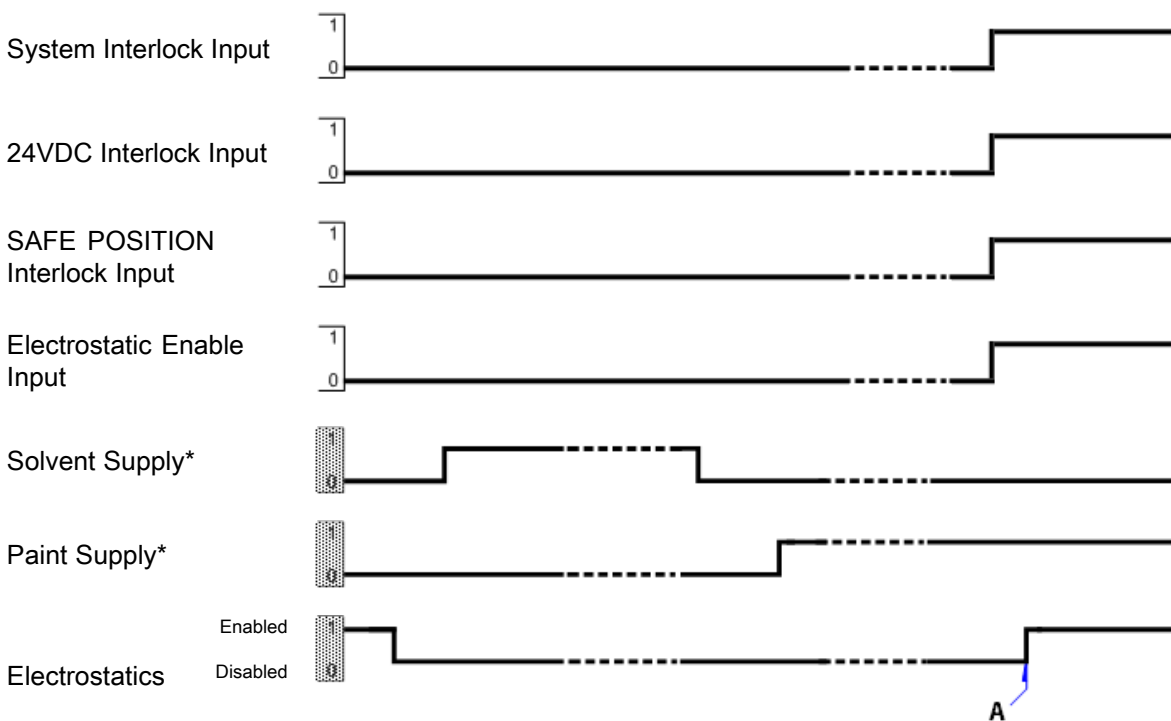

* Not controlled by electrostatic controller

A: Fluid lines free of solvent, OK to activate electrostatics

Controller Display and Features

Screen Areas

There are five areas on the screen used for numerical information. Six additional areas provide non-numerical information.

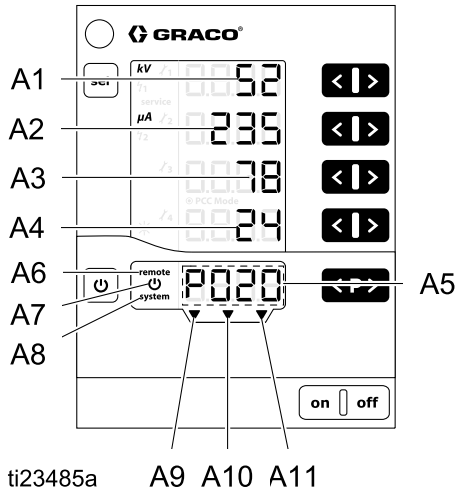

Designation	Function
A1–A4	Displays actual values, preset values, and system parameters. Flashes when the possible range is exceeded.
A5	Displays Preset number, error diagnosis codes, and status information.
A6	REMOTE operation enabled
A7	Electrostatics active/triggered
A8	System interlock connection satisfied
A9	SAFE POSITION Interlock satisfied
A10	24VDC Interlock satisfied
A11	Electrostatic Enable input is Active

Icons

Icon	Explanation
kV	Electrostatic voltage (displayed in kV)
μA	Electrostatic current (displayed in μA)
	Electrostatics activate/trigger
remote	REMOTE operation active. Blinks when the keyboard lock is active
system	System interlock satisfied
	Display backlight illumination (0–8)
	Maintenance reminders
	Static arc setting
	Dynamic arc setting
service	One of the four maintenance counters has reached 0.

Input Keys and Switches

NOTICE
To prevent damage to the softkey buttons, do not press the buttons with sharp objects such as pens, plastic cards, or fingernails.

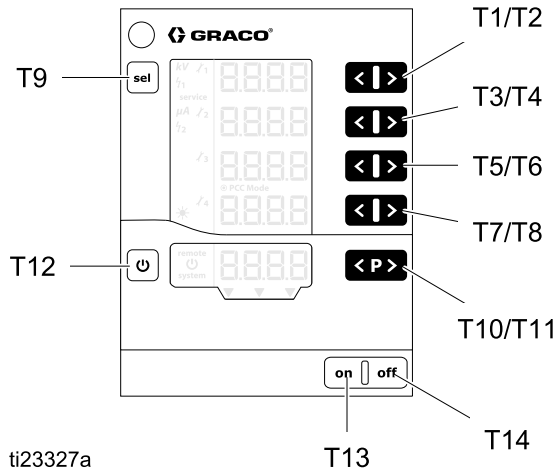

Designation	Function
T1-T8	Input keys for preset values and system parameters or configurations. Used to increase or decrease values shown.
T9	Switch between system parameters (P00–P07) and system configurations (C0–C3)
T10-T11	Preset change.
T12	Electrostatics activate/trigger. Switch between Run and Setup screens.
T13	Controller power on.
T14	Controller power off.

Additional Features

Keyboard Lock

The keyboard lock can be used to prevent changes to individual voltage and current parameter values within the Presets while the controller is operating locally. When the keyboard lock is active, the controller continues to allow:

- Preset selection
- Display of preset values of the current Preset
- Display of the actual values
- Error acknowledgement

Activate/deactivate the keyboard lock

1. Press the key and the (T8) key at the same time.
2. The **remote** display blinks when the keyboard lock is activated.
3. The keyboard lock is cancelled by pressing the same key combination again.

The keyboard lock status remains stored, when switching the controller off and on. The keyboard lock is cancelled if factory defaults are restored.

NOTE: The keyboard lock is independent from the screen lock. The screen lock feature is present in REMOTE operation.



Screen Lock

When in REMOTE mode, the available keypad functions and available screens are limited because a screen lock is active. During screen lock, the available functions are limited to:

- Display of active preset values
- Display of the actual values
- Error acknowledgement

NOTE: If the keyboard was locked when remote mode is entered, the **remote** display will continue to blink.

Checking the Software Version

1. Press the  key and the  at the same time.

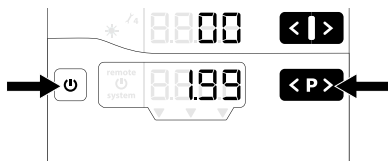

2. The software version is displayed as long as the keys are held.

Restore Factory Defaults

All parameters (**except P00**) and configurations (C0 – C3), as well as all user-defined values, will be overwritten with factory default. Any active keyboard lock or screen lock will be removed.

Maintenance counts, state (active/non-active) and setpoints are NOT reset.

NOTE: By restoring factory defaults, except for display backlight setting, all user-made settings will be set to factory default.

1. Press **off** on the controller.
2. Press and hold .
3. Press **on** on the controller. The **CLr** display blinks.



4. Wait for approximately 5 seconds, until **CLr** disappears.
5. Release the .
6. All values are reset.



Auto Power Save Mode

The display backlight turns off automatically after five minutes of electrostatics inactivity. Touching any key will turn the display backlight back on.

Setup

The Pro Xpc Auto Controller has setup screens that define how the controller functions. This setup is saved in the equipment memory, even when power is removed. The controller is set up by using the system parameters and configuration screens. These values can be adjusted in the setup screens.

1. Press **on** to turn on the controller.
2. To access the Setup Screens, press and hold **U** for 5 seconds from any Run Screen. Press buttons T1/T2 to move between Setup Screens 0-7 (Parameters).

NOTE: Press  to access Setup Screens 8–11 (Configuration). Press buttons T1/T2 to move between Screens 8–11. To return to Setup Screen 1, press  again.

3. To return to the Run Screens, press **U** from any Setup Screen.

This table summarizes the system parameters (P00–P07) that are defined using Setup Screens 0–7. The table also shows the configurations (C0–C3) that are defined using Setup Screens 8–11. Each Setup Screen is then described in detail in the sections that follow the table.

PARAMETERS				
Setup Screen	Display (A1) Value	Description	Display (A3) Values	Display (A4) Value
0	P00	<i>Applicator Type</i> Display A2: APP Use to define applicator type and features. This selection is set in the factory and cannot be changed. This selection is not overwritten if a Factory Default Reset is performed.	0: Standard (solventborne) 1: Waterborne	Std UUb
1	P01	<i>Electrostatic Control Mode</i> Display A2: Ctrl Define how electrostatics generation is controlled. This selection is set to 1 (current) in the factory and cannot be changed.	1: Current Control	CUrr
2	P02	<i>Remote Interface</i> Display A2: bUS Use to select the remote interface from which the controller will accept external control.	0: Off 1: Discrete I/O (default) 2: CAN	oFF dio CAn
3	P03	<i>Analog Input Type</i> Display A2: Ai Use to select the input signal type for the discrete I/O analog inputs.	0: Voltage(default) 1: Current	Volt CUrr
4	P04	<i>Analog Output Type</i> Display A2: Ao Use to select the output signal type for the discrete I/O analog output.	0: Voltage (default) 1: Current	Volt CUrr

PARAMETERS				
Setup Screen	Display (A1) Value	Description	Display (A3) Values	Display (A4) Value
6	P06	<i>CAN Purpose ID</i> Use to set the purpose ID for CAN communication.	0–32 0 (default)	Pid
7	P07	<i>Log level</i> Display A2: LoG Use to designate how much information is logged in the system.	0–5 2 (default)	LoG

CONFIGURATION				
Setup Screen	Display (A1) Value	Description	Display (A2) Values	
8	C0	<i>Arc detection averaging interval Δt [sec]</i> Use to set the time interval that the controller will use to calculate the dynamic arc.	0.01 – 1.00 by 0.01 0.10 (default)	
9	C1	<i>Arc detection blanking time setpoint [sec]</i> Use to set the amount of time after turning on the high voltage during which arc detection is suppressed.	0.0 – 2.0 by 0.1 0.5 (default)	
10	C2	<i>Discharge timer setpoint [sec]</i> Use to set the time needed to fully discharge after turning off the electrostatics.	0.0 – 60.0 by 0.1 0.0 (soventborne default) 30.0 (waterborne default)	
11	C3	<i>Transition Time Interval [sec]</i> Use to set the interval of transition time between electrostatic setpoints.	0.0 – 5.0 by 0.1 0.0 (default)	

Setup Screen 0 (System Type)

Setup Screen 0 (Parameter P00) displays the type of electrostatic applicator (APP) in use. The Pro Xpc Auto Controller is factory set to 0 (Std) or 1 (UUb) and cannot be changed.

NOTE: This parameter is not overwritten if a Factory Default Reset is performed.

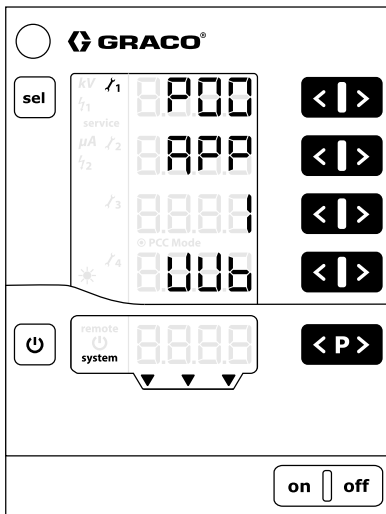
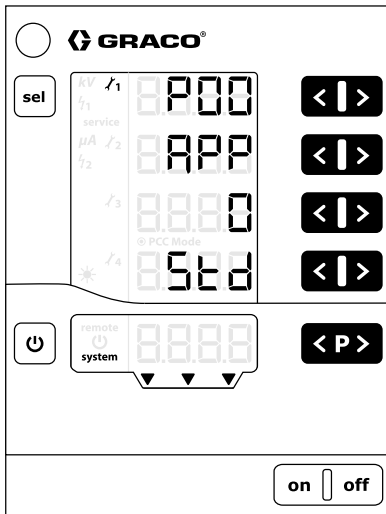

Std: Solventborne product: 100 kV maximum

UUb: Waterborne product: 60 kV maximum

Setup Screen 1 (Electrostatics Control Mode)

Setup Screen 1 (Parameter P01) displays the electrostatics control mode (Ctrl) in use. The Pro Xpc Auto Controller is factory set to Current (1, CUrr) and cannot be changed.

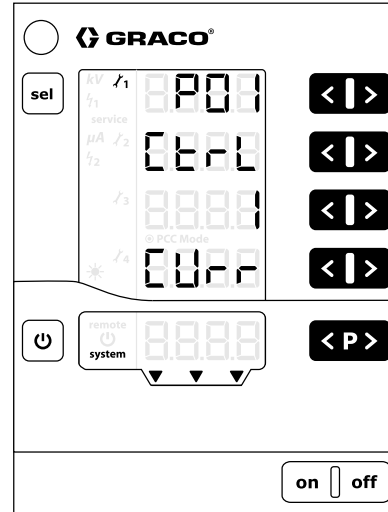

Setup Screen 2 (Remote Interface)

Use Setup Screen 2 (Parameter P02) to select the remote interface (bUS) from which the controller will accept external control. Press buttons T5/T6 to change the setting.

The options are:

- **0 = oFF**: Discrete I/O interface is disabled (local operation).
- **1 = dio**: Discrete I/O interface is enabled. This selection is the default. See [Discrete I/O, page 19](#), for more information.
- **2 = CA_n**: CAN interface is enabled. The CAN interface is used to communicate with Graco modules. When CAN interface is enabled, the following Discrete I/O functions are disabled:
 - Current Setpoint Input (Pin 9)
 - Voltage Setpoint Input (Pin 10)
 - Preset Select 1 and 2 (Pins 1 and 2)
 [See [Discrete I/O, page 19](#).]

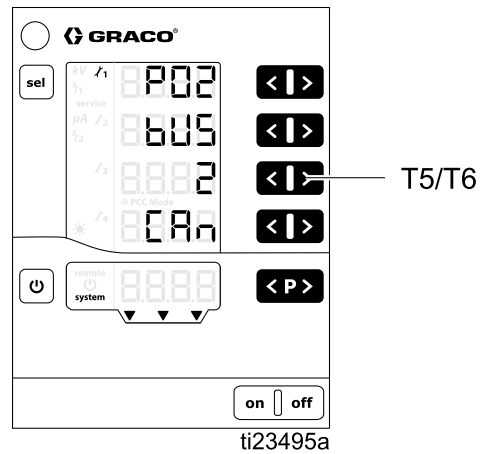
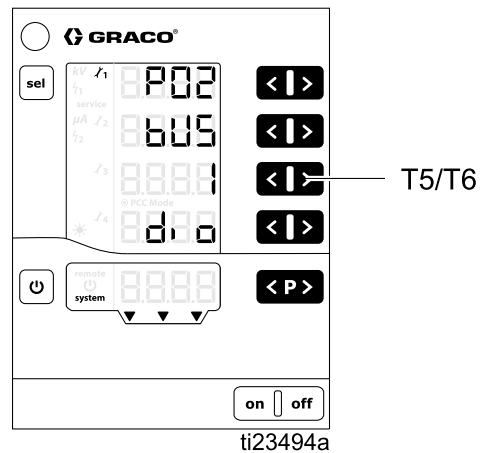
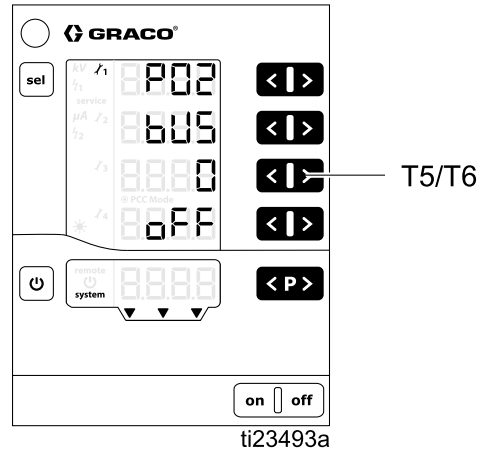

Setup Screen 3 (Analog Input Type Select)

Use Setup Screen 3 (Parameter P03) to select the input signal type for the discrete I/O interface analog inputs (Ai). Press buttons T5/T6 to change the setting. The options are:

- **0 = Volt:** Analog voltage inputs are voltage type (0 - 10 V). This selection is the default.
- **1 = Curr:** Analog current inputs are current type (4 - 20 mA).

This setting applies to Current Setpoint and Voltage Setpoint analog inputs for the Discrete I/O interface. See [Discrete I/O, page 19](#), for more information.

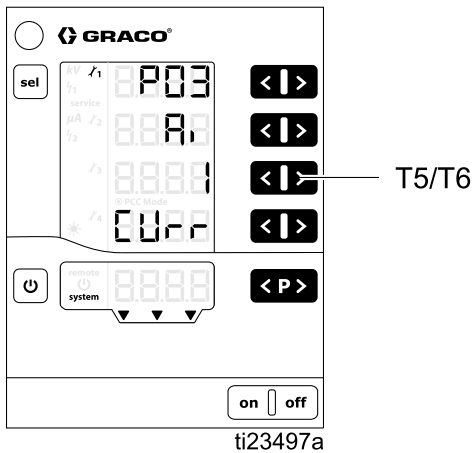
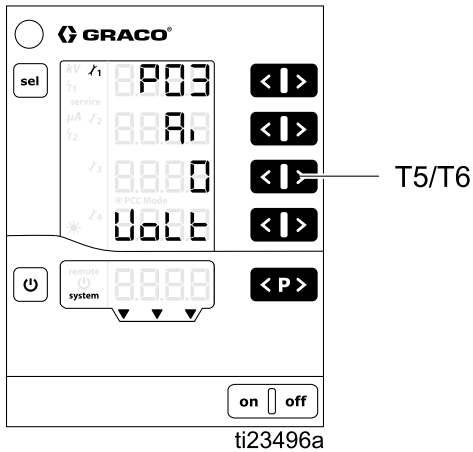

Setup Screen 4 (Analog Output Type Select)

Use Setup Screen 4 (Parameter P04) to select the output signal type for the discrete I/O interface analog outputs (Ao). Press buttons T5/T6 to change the setting. The options are:

- **0 = Volt:** Analog outputs are voltage type (0-10V). This selection is the default.
- **1 = Curr:** Analog outputs are current type (4-20mA).

This setting applies to Actual Spraying Current and Actual Spraying Voltage analog outputs for the discrete I/O interface. See [Discrete I/O, page 19](#), for more information.

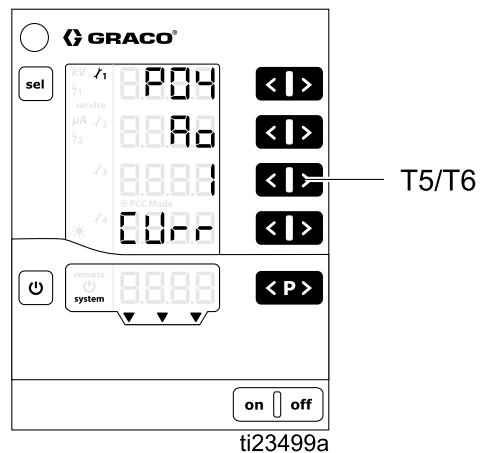
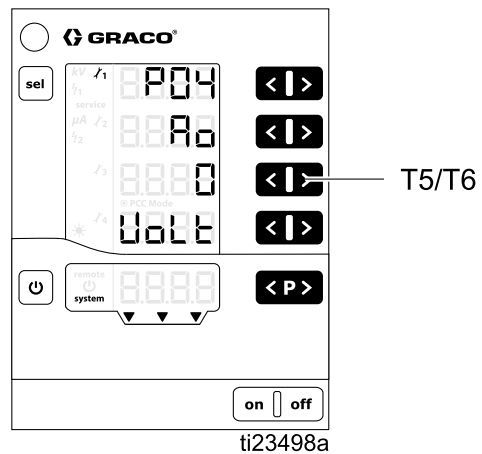

Setup Screen 6 (CAN Purpose ID)

Use Setup Screen 6 (Parameter P06) to select the CAN purpose ID of the controller. For one gun systems, set the value to 0 (default). For a multi-gun system, set the CAN purpose IDs to match each gun number. For example:

- 0 = gun 1
- 1 = gun 2

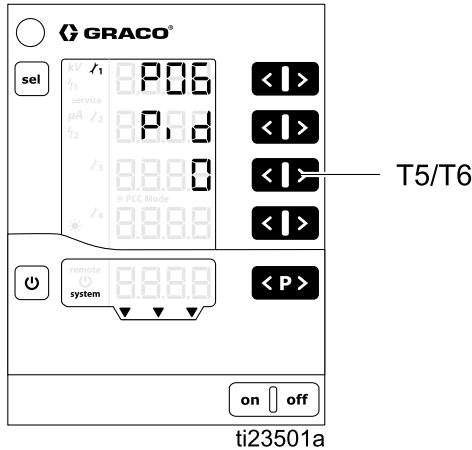

Setup Screen 7 (Log Level)

Use Setup Screen 7 (Parameter P07) to select the log level (LoG) for how much information is logged in the system (used for troubleshooting only). Press buttons T5/T6 to change the setting. A setting of 0 means nothing is logged. A setting of 5 means everything is logged. 2 is the default.

NOTE: For logging, a micro SD card must be inserted in the slot found on the main circuit board. If a software update has been done by installing a micro SD card, this card can be used for logging. If no card has been installed, or to verify whether one is present, see [Software Update, page 61](#).

The controller can export log reports of controller activity to an installed micro SD card for test purposes and for finding defects.

NOTE: If a micro SD card is present when the controller is turned on, the log messages are recorded in a file (MESSAGES.LOG) located in the root directory. When the file size reaches 32 MB, it is renamed MESSAGES.1 and a new MESSAGES.LOG file is created. Subsequent log file names will be sequentially numbered.

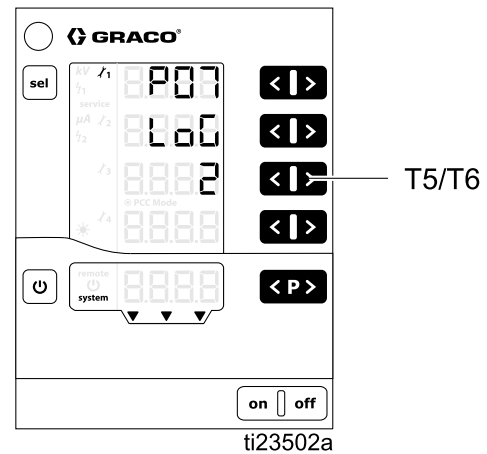

Setup Screen 8 (Averaging Interval)

Use Setup Screen 8 (Configuration C0) to select the averaging interval (in seconds) used to calculate the dynamic arc. Press buttons T3/T4 to change the setting. The default is sufficient for most applications.

See [Arc Detection, page 50](#) for more information.

- Range is 0.01 – 1.00 by 0.01
- Default 0.10 (shown)

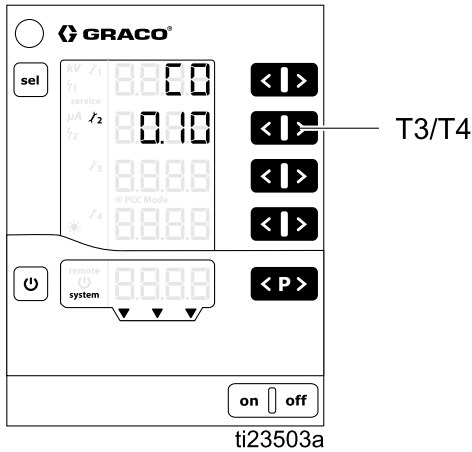

Setup Screen 9 (Blanking Time)

The Pro Xpc Auto Controller uses a fixed blanking time which is defined by this screen. The blanking time is the time between when electrostatics are activated and Arc Detection is enabled. Adjust the Blanking time duration to ensure that the system reaches full voltage during the Blanking time. If arc detection errors occur when the electrostatics are activated, increase the Blanking time or adjust the arc detection parameters to be less sensitive, as defined in [Run Screen 2 \(Arc Limits\), page 48](#) and [Arc Detection, page 50](#).

Use Setup Screen 9 (Configuration C1) to select the time (in seconds) for which arc detection is disabled (blanking time) after electrostatics are activated. This setting controls the time from when the electrostatics are enabled until arc detection is enabled. Press buttons T3/T4 to change the setting.

See [Arc Detection, page 50](#) for more information.

- Range is 0.0 – 2.0 by 0.1
- Default is 0.5 (shown)

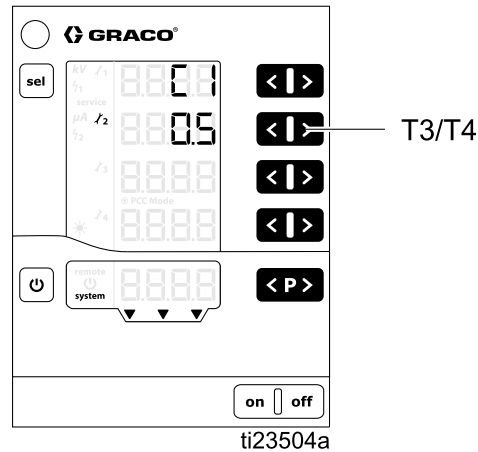

Setup Screen 10 (Discharge Time)

Use Setup Screen 10 (Configuration C2) to select the time (in seconds) from when the electrostatics are disabled until the electrostatic voltage is discharged. Press buttons T3/T4 to change the setting. For most solventborne systems, this setting can remain at 0.0, as no discharge time is needed for a solventborne system.

In a waterborne system, set the discharge timer to a value that will ensure that the system has been discharged. Verify that the system is discharged using the Fluid Voltage Discharge and Grounding Procedure in gun manual 332992.

- Range is 0.0 – 60.0 by 0.1
- Solventborne default is 0.0 (shown)
- Waterborne default is 30.0 (not shown)

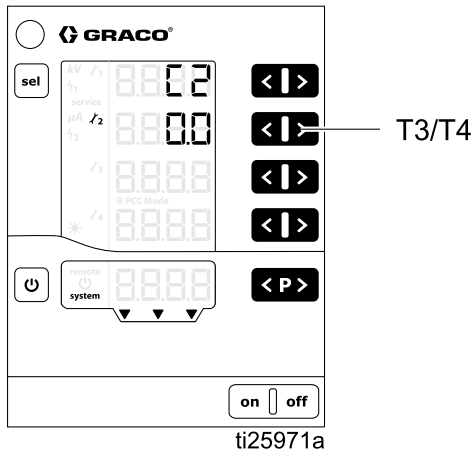

Setup Screen 11 (Transition Time)

The transition time is the time over which the controller changes the electrostatics. The transition time applies when electrostatics are enabled or when the Voltage Setpoint is changed. Arc detection remains active when the voltage setpoint is changed. If arc detection errors occur when the voltage (or current) setpoint is changed, increase the transition time or adjust the Arc Detection parameters to be less sensitive (see [Arc Detection, page 50](#)).

Use Setup Screen 11 (Configuration C3) to set the interval of transition time (in seconds) for the electrostatic output. This setting will help eliminate nuisance arc detection errors during transition time. Press T3/T4 to change the setting.

- Range is 0.0 – 5.0 sec
- Default is 0.0 (shown)

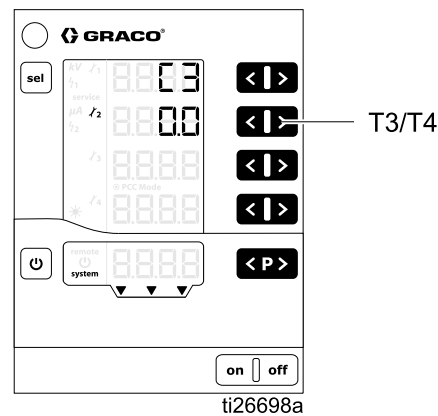

Operation

System Start-up

Press **on** to turn on the controller. The controller always starts up to the last configured settings. The controller has two sets of screens, Run and Setup. This section includes information on the Run screens, used to operate the electrostatic gun. See [Setup Screens, page 38](#), If you have not yet completed initial setup.

Press and hold  to toggle between the Run screens and the Setup screens.

NOTE: When viewing Run Screens, after 5 seconds have elapsed since the last keystroke, the display will revert to Run Screen 1.

Presets



The Pro Xpc Auto Controller has 251 (P000-P250) user-defined Presets. There are four values associated with each Preset. These are:

- Voltage setpoint
- Current setpoint
- Static arc limit
- Dynamic arc limit





Voltage and current setpoints are specified on [Run Screen 1 \(Electrostatics Readings\), page 47](#). Arc limits are specified on [Run Screen 2 \(Arc Limits\), page 48](#).

NOTE: Only Presets P000-P003 are accessible through the discrete I/O interface. The CAN interface runs in preset P000 only. All Presets (P000-P250) are accessible in local mode.

Run Screen 1 (Electrostatics Readings)

				
<p>To reduce the risk of electric shock, do not use the Pro Xpc Auto Controller readings to determine if your system is discharged. The controller will only display the voltage while the gun's power supply is operating. Follow the Fluid Voltage Discharge and Grounding Procedure described in your gun manual.</p>				

Run Screen 1 is the main screen for an electrostatic gun. This screen shows the active Preset (A5) and set points for voltage (A1) and current (A2). The screen also displays actual values for kV and μA when the electrostatics are active/triggered. Actual values are displayed in green.

Use this screen to set the voltage (A1) and current (A2) set points for each Preset. The set point is displayed in black. Set points can be changed by pressing the corresponding  and  keys when actual values are displayed. The set points also can be viewed by pressing  or  once.

NOTE: When in REMOTE operation, these values cannot be changed using the display keys.

Press  to select the Preset (P000 — P250).

Press  to acknowledge error codes.

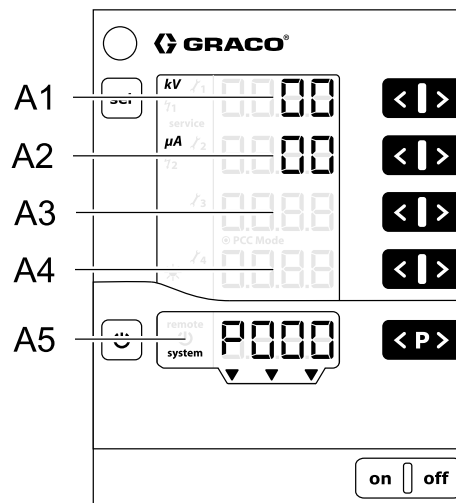

ti23486a

Location	Description	Units	Range	Default
A1	Black: Voltage Setpoint Green: Spraying Voltage	kV	0–100kV (solventborne) 0–60kV (waterborne)	0kV
A2	Black: Current Setpoint Green: Spraying Current	μA	0–150 μA	0 μA
A3–A4	None	—	—	—
A5	Active Preset, error diagnosis, or status	—	—	—

Run Screen 2 (Arc Limits)

Run Screen 2 is the secondary screen for the electrostatic gun. This screen shows the active Preset, arc detection limits, and screen backlight brightness. Screen backlight brightness is set 0–8, with zero being Off and 8 being the brightest. **NOTE:** The screen will dim automatically after 5 minutes of inactivity. The screen backlight brightness is not reset if factory defaults are restored.

Arc detection is a safety feature of the Pro Xpc Auto Controller. Arc detection is used to detect when grounded objects are too close to the electrostatic spraying device. If this occurs, the controller shuts down electrostatic generation instead of creating an electrical discharge.

The static arc limit is used to detect a grounded object that is stationary or slow moving. The dynamic arc limit is used to detect grounded object that is fast moving. For both static and dynamic arc limits, lower values are more sensitive than higher values. The set points can be changed by pressing the corresponding **<** and **>** keys.

See [Arc Detection, page 50](#), for more information.

NOTE: It is recommended that arc detection settings not be changed from defaults. Any desired change must be set individually for every Preset.

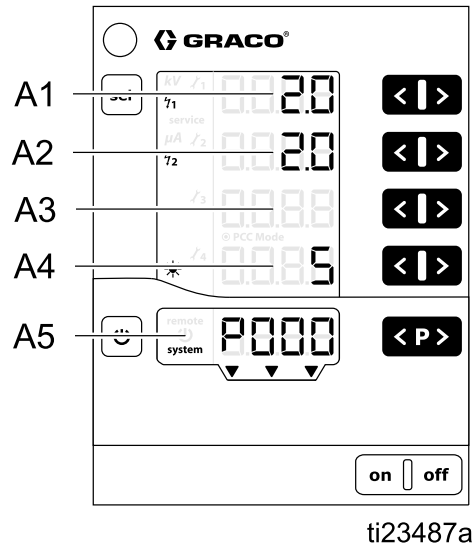

Location	Description	Range	Default
A1	Static Arc Limit	0.1–50 nS	10 nS
A2	Dynamic Arc Limit	0.1–25 nS/s	8.0 nS/s
A3	None	—	—
A4	Screen Backlight Brightness	0–8	5
A5	Active Preset, error diagnosis, or status	—	—





Run Screen 3 (Maintenance Counters)



Run Screen 3 is the maintenance screen. This screen shows the 4 maintenance counters and the non-resettable trigger counter.

When dashes are shown in the maintenance counters, monitoring is deactivated. When numbers are shown, the maintenance counters show days of remaining service life.

NOTE: Maintenance counters are activated only when electrostatics are active/triggered.

NOTE: The trigger counter shows an amount of time (in days) that electrostatics have been activated for the connected power supply. It cannot be cleared. Each tenth equates to 2.4 hours of elapsed time.

To activate monitoring: press the corresponding  and  simultaneously for a deactivated counter. During the first activation a value of 1 is shown as the start value. If monitoring has already been activated at some earlier point, then the last stored value is displayed. Set the desired service life for each wearing part using the  and .

To deactivate monitoring: press the corresponding  and  simultaneously for an active counter.

If the selected service life is exceeded, the maintenance counter will be shown as a negative number. The **service** symbol also will appear. Controller operations are not stopped.

NOTE: Maintenance counters, states (active/inactive), and set points are not reset when factory defaults are restored.

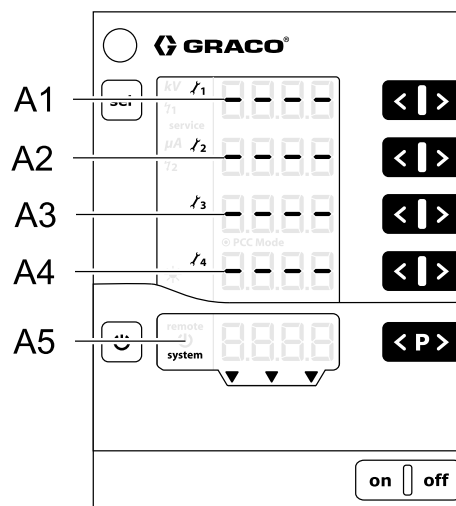

ti23488a

Designation	Function	Units	Range
A1–A4	Maintenance counter 1–4	days	0.1–500
A5	Trigger counter, error diagnosis, or status	days	—

Arc Detection

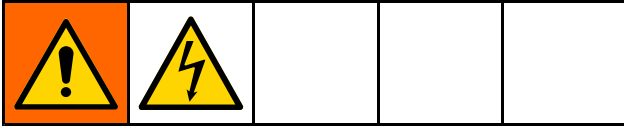

The primary method to prevent arcing is to keep all grounded objects at least 8 in. (20.3 cm) away from the applicator. In addition, the Pro Xpc Auto Controller is equipped with a feature called arc detection. When the conditions suitable to create an arc have been detected, the arc detection circuitry disables the power supply drive circuitry and produces an arc detection error. The power supply drive circuitry remains disabled until the error has been confirmed by the user or the PLC.

The controller has two adjustable arc detection parameters: Static Arc Limit and Dynamic Arc Limit:



- Static Arc Limit monitors the ratio between current and voltage. This ratio is affected by the distance from the applicator to a ground and by the resistivity of the fluid. The system turns off the high voltage if this ratio gets too low.

- Dynamic Arc Limit monitors the rate of change of the ratio between current and voltage. If a grounded object approaches the applicator at too high a speed, the system turns off the high voltage.

Both parameters can be set by the user to be more or less sensitive than the factory default. See [Run Screen 2 \(Arc Limits\), page 48](#). Static Arc Limit detection is adjustable on a scale from 0.1 – 50. Dynamic Arc Limit detection is adjustable from 0.1 – 25. Both Static Arc Limit and Dynamic Arc Limit detection are less sensitive as the value is increased.

Check Arc Detection Function

Periodically check the function of the arc detection feature. Under safe conditions, with electrostatics activated, approach the gun electrode with a grounded rod and verify that the electrostatics deactivate. Observe the display to verify that an error code of H15, H16, H17, or H18 is displayed.

Setting	Remarks
Static Arc Limit *  View or change on Run Screen 2 , Location A1	Range: 0.1–50 nS Set the value lower to increase sensitivity and to deactivate the electrostatics sooner as a grounded object approaches the applicator. Set the value higher to decrease sensitivity and to eliminate nuisance errors.
Dynamic Arc Limit *  View or change on Run Screen 2 , Location A2	Range: 0.1–25 nS/s Set the value lower to increase sensitivity and to deactivate the electrostatics sooner if a grounded object is approaching the applicator at too high a speed. Set the value higher to decrease sensitivity and to eliminate nuisance errors.

* Must be set for each Preset.

Averaging Interval

The arc detection averaging interval is used for calculating the Dynamic Arc Limit. The lower the averaging interval, the more sensitive the Dynamic Arc Limit becomes. Lowering this setting adds to

the sensitivity achieved by setting the Dynamic Arc Limit itself. The default averaging threshold is adequate for most applications. Use Setup Screen 8 (Configuration C0) to view or change.

Setting	Remarks
Configuration C0 on Setup Screen 8 Valid for all Presets	Averaging Interval Averaging interval for dynamic arc calculation. Range: 0.01–1.00 s by 0.01 Lower = more sensitive
Configuration C1 on Setup Screen 9 Valid for all Presets	Blanking Time Arc detection is suppressed from when electrostatics are activated until the blanking time has elapsed. Range: 0.0–2.0 s by 0.1 Lower = more sensitive

Blanking Time

The Pro Xpc Auto Controller uses a fixed blanking time, which is defined by the configuration C1 on *Setup Screen 9*. The Blanking time is the time between when electrostatics are activated and Arc Detection is enabled. Adjust the Blanking time duration to ensure the system reaches full voltage during the Blanking time. If arc detection errors occur when the electrostatics are activated, increase the Blanking time or adjust the Arc Detection parameters to be less sensitive.

Arc detection is deactivated during the blanking time.









1. Activate the electrostatics only when the applicator is in SAFE POSITION.
2. Do not move the gun out of the SAFE POSITION before the blanking time has elapsed and arc detection is active.

Use interlocking signals between the controller and the device performing the gun's motion control. See [SAFE POSITION Mode, page 28](#) for more information.



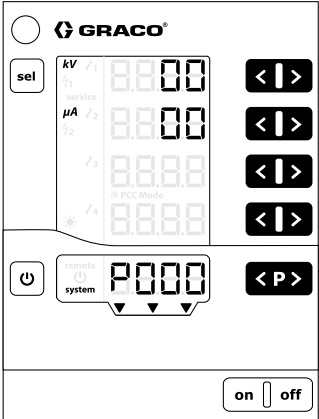
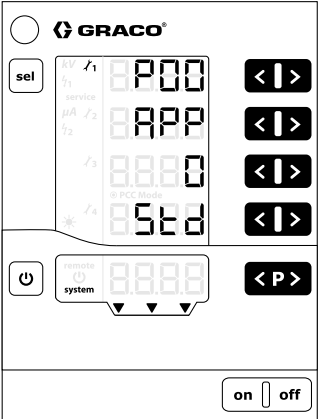
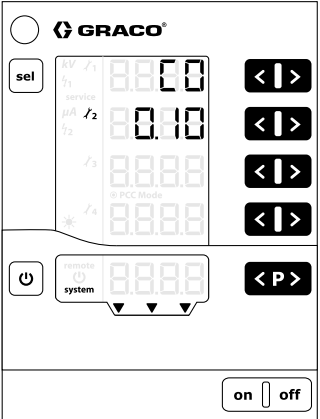

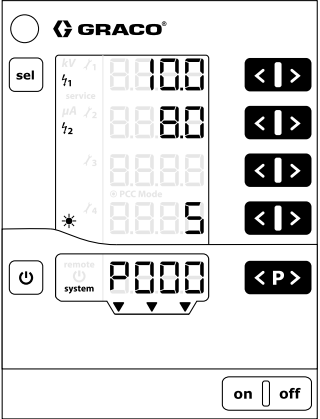
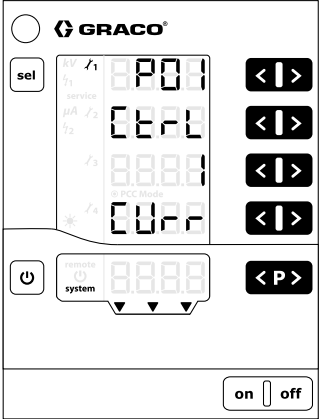
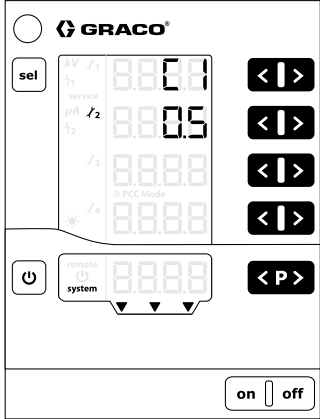
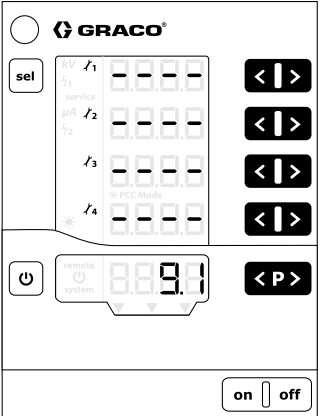
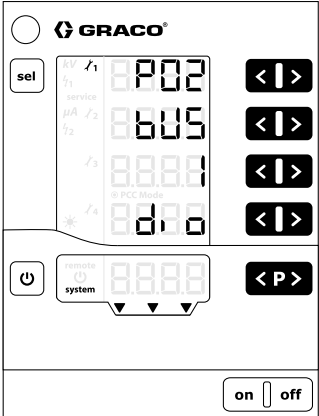
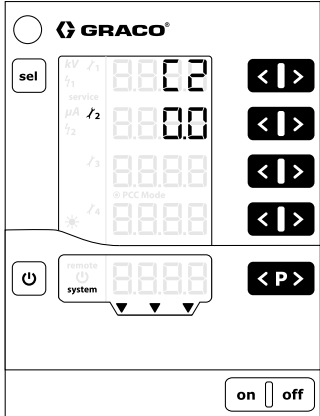
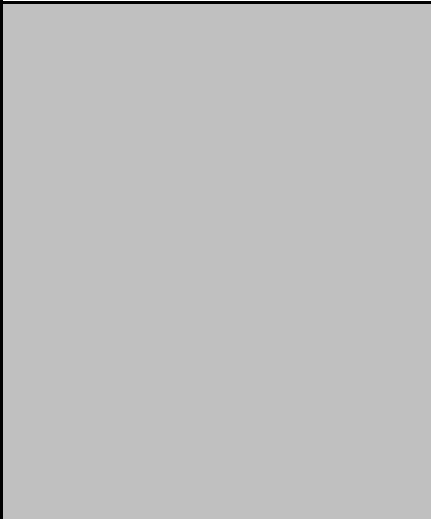
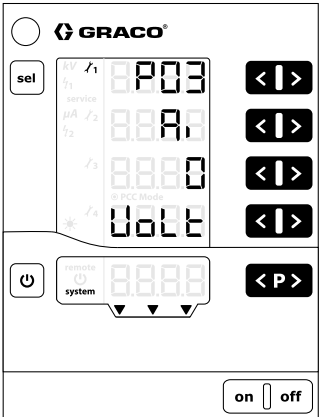
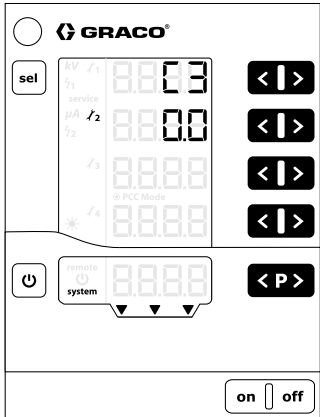

Transition Time

When the electrostatics are activated, or the setpoints are changed during operation, the changes may temporarily exceed the limits set by arc detection. To avoid shutdown, the electrostatics change over an interval called Transition Time.

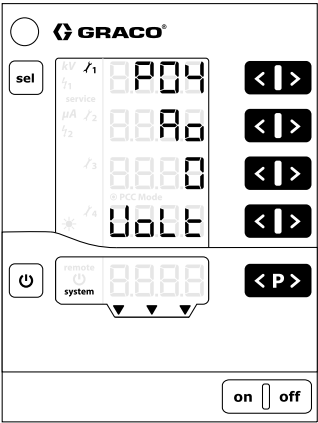
Screen Map

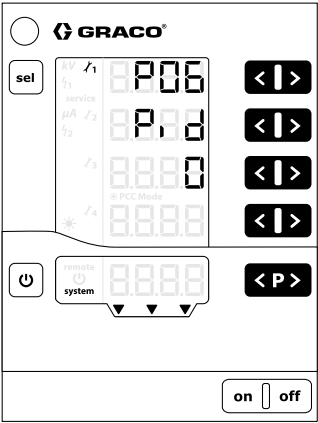
<p>RUN</p> <p>Press and hold  for 5 seconds from any SETUP screen. Also shown on power up.</p>	<p>SETUP SCREENS 0-7 (Parameters)</p> <p>Press and hold  for 5 seconds from any RUN screen. Or, press  from SETUP SCREENS 8-11. Screens that are not implemented for the Pro Xpc Auto Controller are not shown.</p>	<p>SETUP SCREENS 8-11 (Configurations)</p> <p>Press  from SETUP SCREENS 0-7.</p>
	<p>Solventborne or Waterborne</p> 	
	 T1/T2	 T1/T2

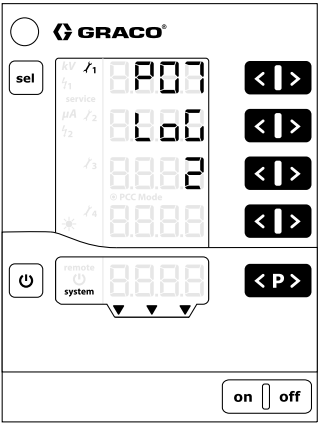
RUN	SETUP SCREENS 0-7 (Parameters)	SETUP SCREENS 8-11 (Configurations)
		
<p style="text-align: center;">sel</p>	<p style="text-align: center;">← T1/T2</p>	<p style="text-align: center;">← T1/T2</p>
		
<p style="text-align: center;">sel</p>	<p style="text-align: center;">← T1/T2</p>	<p style="text-align: center;">← T1/T2</p>
		
	<p style="text-align: center;">← T1/T2</p>	<p style="text-align: center;">← T1/T2</p>

RUN	SETUP SCREENS 0-7 (Parameters)	SETUP SCREENS 8-11 (Configurations)
		
		
		
		
		
		

Troubleshooting

Error Codes

The Pro Xpc Auto Controller is monitored constantly. If a error is detected, an error message is indicated with a error code.

The error codes are shown in red on the **A5** display.



The four most recent error codes are stored by the order of their appearance. Each error in the list must be acknowledged with the **<P>** key. If an error code is shown, the **<P>** key cannot be used for other functions

The table below shows all possible error codes for the Pro Xpc Auto Controller.

Code	Description	Criteria	Controller Action	Solution
Electrostatics				
H11	Gun Failure	The controller does not detect a current from the gun, or detects a current that is too low.	Stop	<ul style="list-style-type: none"> Verify gun power cable connection, perform Gun Power Cable Continuity, page 57, and replace cable if needed. Replace gun power cable or gun power supply if needed.
H12	High Voltage Overvoltage	Measured voltage output is greater than 105 kV.	Stop	<ul style="list-style-type: none"> Verify system grounding. Verify gun power cable connection and perform Gun Power Cable Continuity, page 57. Replace gun power cable or gun power supply if needed.
H13	Gun Supply Overvoltage	Gun voltage is too high.	Stop	<ul style="list-style-type: none"> Verify gun power cable connection, perform Gun Power Cable Continuity, page 57, and replace cable if needed. Replace gun power cable or gun power supply if needed.
H15	Arc detection static limit	The static arc detection threshold is exceeded. A grounded object came too close to the applicator.	Stop	<ul style="list-style-type: none"> Verify closest distances to parts. Verify paint conductivity. Verify spraying parameters associated with static arc detection, see Run Screen 2 (Arc Limits), page 48.
H16	Arc detection dynamic limit	Dynamic arc detection threshold exceeded. A grounded object approached the applicator at too high of a speed.	Stop	<ul style="list-style-type: none"> Verify fastest approach to parts. Verify paint conductivity. Verify spraying parameters associated with dynamic arc detection, see Run Screen 2 (Arc Limits), page 48.

Code	Description	Criteria	Controller Action	Solution
H17	Arc detection both limits	A grounded object came too close to the applicator at too high of a speed.	Stop	<ul style="list-style-type: none"> Verify closest distances to parts. Verify fastest approach to parts.
H18	Arc detection unspecified	Arc detection triggered due to unspecified reason	Stop	<ul style="list-style-type: none"> Verify paint conductivity. Verify spraying parameters associated with arc detection, see Run Screen 2 (Arc Limits), page 48.
H91	Power Supply Communication Error	Communication between controller and power supply failed	Stop	<ul style="list-style-type: none"> Verify gun power cable connection, perform Gun Power Cable Continuity, page 57, and replace cable if needed. Replace gun power cable or gun power supply if needed.
Internal Controller Errors				
H20	Controller mainboard voltage tolerance	Onboard generated voltage is out of tolerance	None	<ul style="list-style-type: none"> Verify all connections inside of controller are properly made. Verify power source is good.
H21	Controller mainboard voltage failure	24V supply drops below 21V. Remark: No error code is displayed	Shutdown	<ul style="list-style-type: none"> Replace 24VDC board or power board if necessary.
H24	Memory contents invalid	Magic number doesn't match expected value	Initialize defaults	<ul style="list-style-type: none"> Verify all connections inside of controller are properly made.
H25	Memory write timeout	Writing to EEPROM takes longer than 10ms	None	<ul style="list-style-type: none"> Replace main board if necessary.
H26	Memory shutdown error	Data to be written at power off hasn't been properly saved to the EEPROM	None	<ul style="list-style-type: none"> Do not turn off controller so quickly after making setting changes. Verify all connections inside of controller are properly made. Replace main board if necessary.
H27	Memory verify failure	Verification of the data written to the EEPROM failed	None	<ul style="list-style-type: none"> Verify all connections inside of controller are properly made. Replace main board if necessary.
H80	Safety controller communication Error	No response/timeout to a request. Error report on command execution. Response data mismatch	Stop	<ul style="list-style-type: none"> Verify all connections inside of controller are properly made. Verify software version and upgrade if needed.
H81	Safety controller self-test failure	The self-test performed by the safety controller detected an error	Stop	<ul style="list-style-type: none"> Replace main board if necessary.
H82	Safety controller not alive	Heartbeat message timeout	Stop	
H90	Gun controller communication error	No response/timeout to a request. Error report on command execution. Response data mismatch	None	
H92	Gun controller not alive	Heartbeat message timeout	Stop	

Code	Description	Criteria	Controller Action	Solution
H94	Gun controller update required.	The gun controller firmware requests an update.	None	<ul style="list-style-type: none"> Verify the software version and update.
H95	Invalid applicator type detected	The incorrect power supply is connected to the controller	Stop	<ul style="list-style-type: none"> Verify that the power supply is meant to be used with this controller.
Graco CAN Bus Errors				
H40	CAN Bus Off	The CAN controller went to bus off state due to permanent bus error.	Stop	<ul style="list-style-type: none"> Verify that parameter P02 on Setup Screen 2 is set to CAN mode and parameter P06 on Setup Screen 6 is correct. Verify CAN cable connections. Verify that CAN devices are connected and functioning. Replace CAN board, if necessary.
H41	CAN Error Passive	The CAN controller went to error passive state due to repeated bus errors.	Stop	
H42	CAN receive overflow	CAN messages are arriving too quickly.	Stop	
H43	CAN receive FIFO overflow	CAN messages arrive faster than they can be transferred to the receive queue.	Stop	
H44	Remote enable communications error	The CAN remote enable heartbeat has stopped being transmitted.	Stop	
Other Errors These will be logged, but not likely to be seen on the display due to restart				
H901	Assertion failed	Violation of a mandatory precondition	Restart	<ul style="list-style-type: none"> Verify that all connections inside of the controller are properly made. Restart controller. Verify software version and upgrade if needed. Replace main board if necessary.
H902	Out of memory	Memory allocation failed	Restart	
H903	Watchdog timeout	Watchdog wasn't serviced timely	Restart	
H904	Stack Overflow	A stack overflow has been detected.	Restart	
H905	Hard fault error	The CPU detected a hard fault	Restart	
H999	Other fatal error	Unspecified fatal error	Restart	

Gun Power Cable Continuity

To ensure that the gun power cable has not been damaged, it may be necessary to verify the electrical integrity of the cable. To check continuity, perform the following:

1. Power down the system.
2. Remove the gun power cable.
3. Refer to the cable schematic in [Connections, page 17](#). Use an ohmmeter to check each pin at each connector against all other listed pins to verify continuity where indicated, or isolation between other pins.

Repair

Individual items used in this controller are not repairable. If they fail, they must be replaced. See [Parts, page 63](#), for a list of repair kits.

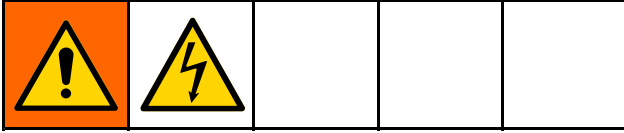

Main Circuit Board or Keypad Membrane Removal

1. Remove power from the system.
2. Remove four screws, then remove the controller access cover.

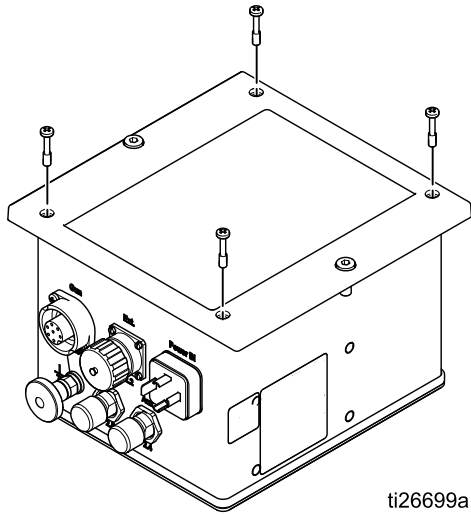

3. Remove connectors from the main board and from the power supply, as shown.

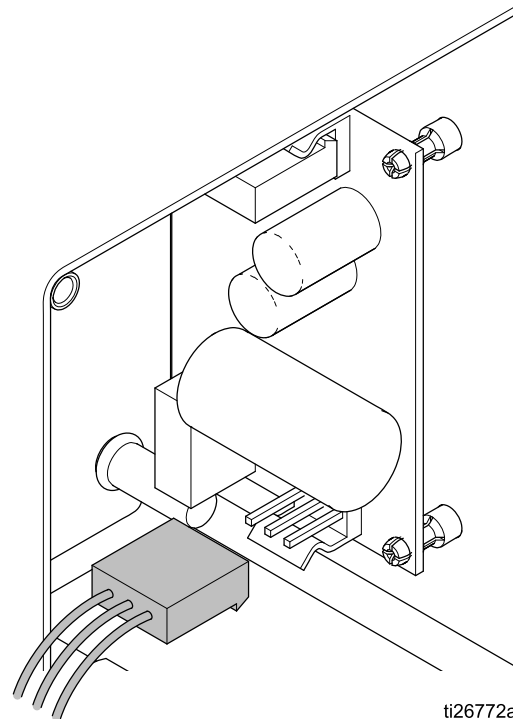
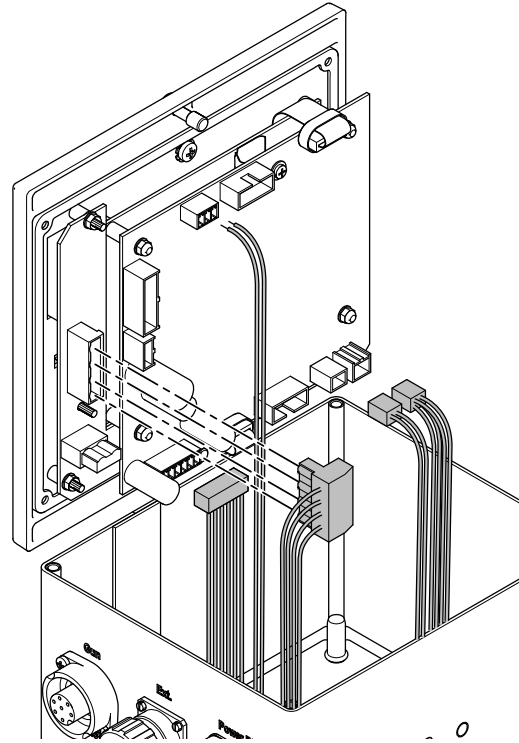

- Using a 5.5 mm tool, remove four nuts from the main board. Disconnect the three remaining cables.

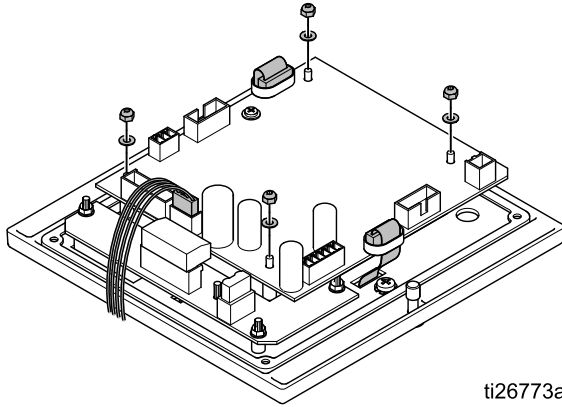

ti26773a

- Lift the main board carefully out of the module.
- Remove four nuts and washers. Lift the power board carefully out of the module.

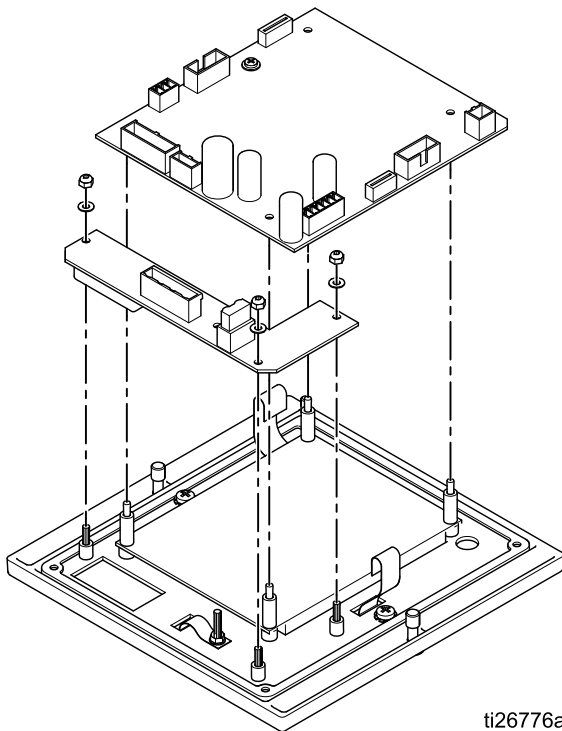

ti26776a

- Remove 4 spacers, then remove the LCD panel.

- Remove 2 screws and lift out the membrane (button) panel.

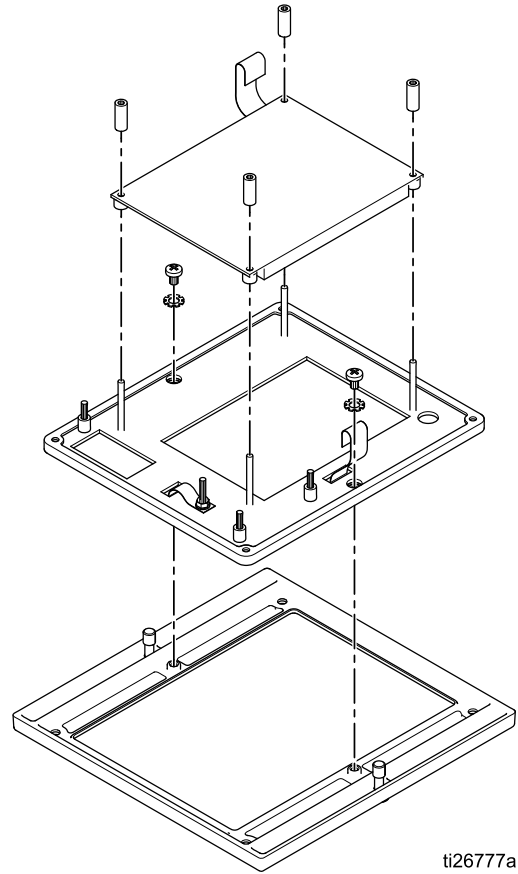

ti26777a

Power Board Removal

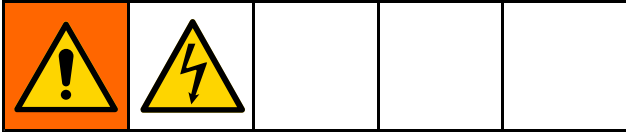

1. Remove power from the system.
2. Remove four screws, then remove the back access panel.

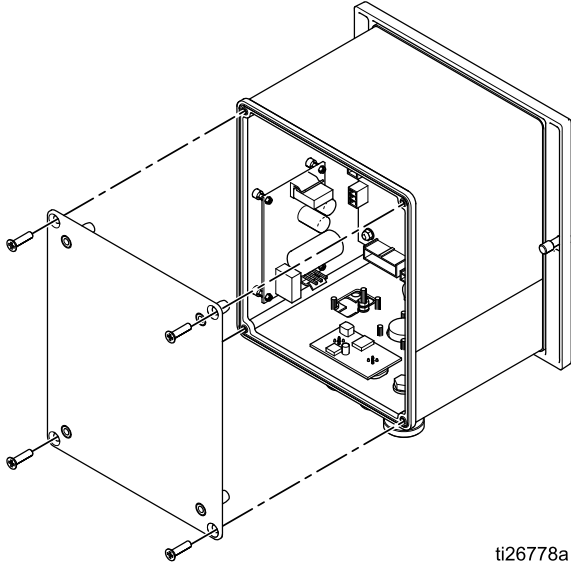

3. Remove the two electrical connectors from the power board, as shown.

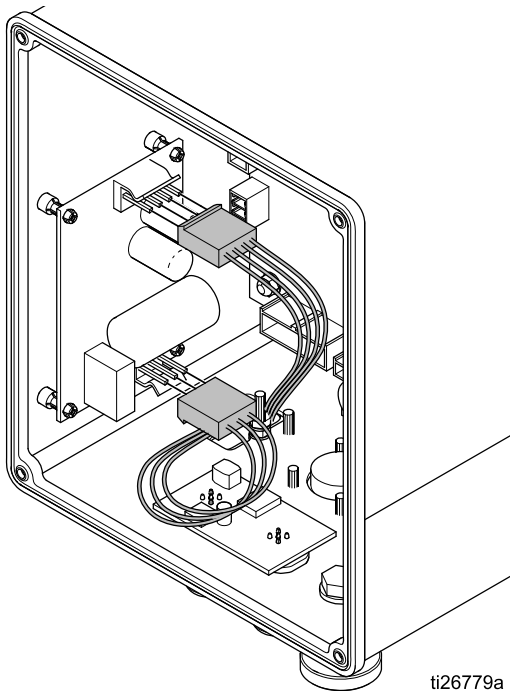

4. Gently pry the power board from the four retaining clips and remove the board, as shown.

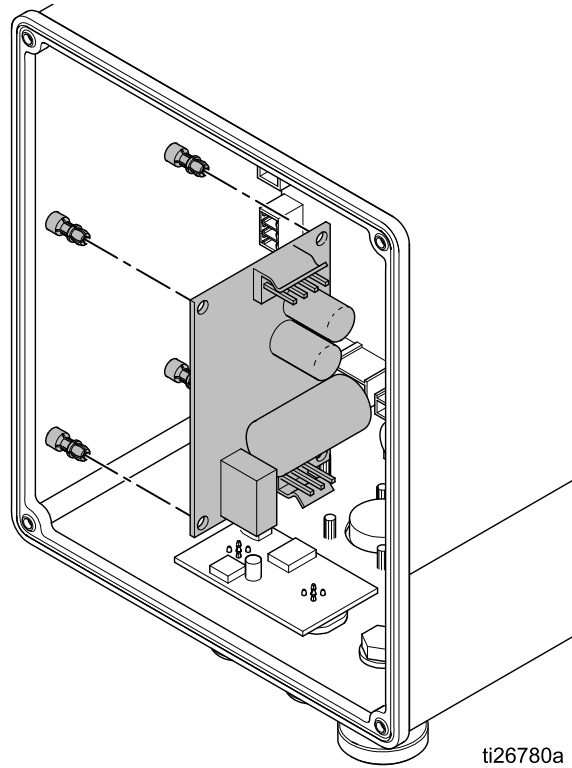

Software Update

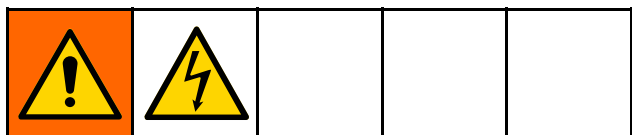

NOTE: Prior to beginning a software update, make a written copy of Preset settings that have been defined for use with the specific materials being applied with this system. This will ensure that the information is recoverable in the event the software update resets Presets to factory settings.

1. Obtain the software update files, (17B730.zip). Unzip the file. There may be one or more files required for the update. Put all files in the root directory of a microSD card.

NOTE: If a microSD card is already in the main board, this step will need to be performed after step 4.

NOTE: There are limitations to the memory size of the microSD card that can be supported.

Type	Maximum
SD	2 GB
SDHC	32 GB
Do not use SDXC cards unless they are formatted to FAT32 file format.	

2. Switch off the Pro Xpc Auto Controller and remove power from the system.
3. Remove four screws, then remove the controller access cover.

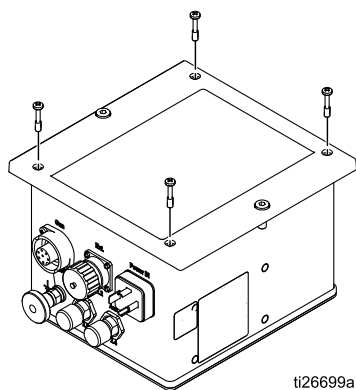

t126699a

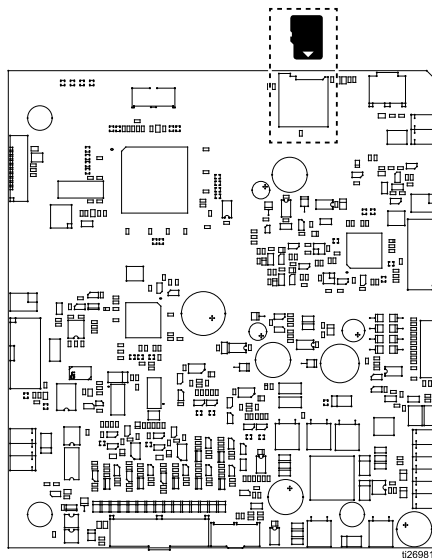

4. Find the microSD card slot on the top of the main board, and insert the microSD card with the software update.

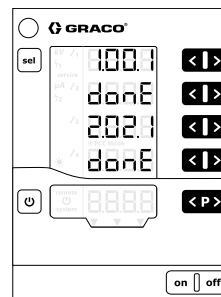

5. Carefully place the controller access cover onto the controller box. Do not screw down.
6. Apply power to the Pro Xpc Auto Controller and press the **on** button. The screen should blink and display **donE** when the reprogramming is complete.



Repair

7. Press any button to return to normal operation.
8. Verify the software version by holding  and  at the same time.
9. Switch off the Pro Xpc Auto Controller and remove power from the system.
10. If desired, remove the microSD card from the slot, or replace the microSD card with another. Having a microSD card in the slot will allow the controller to store log files. See [Setup Screen 7 \(Log Level\)](#), page 43 for information about logging.
11. Replace the controller access cover.
12. Screw down the front access cover.
13. Reapply power and switch on the Pro Xpc Auto Controller.

Parts

Pro Xpc Auto Controller 24Y307 (solventborne system) and 24Y308 (waterborne system)

Part No.	Description
17H039	Discrete I/O Cable (included)
223547	Ground Wire (included)
24Y335	Pro Xpc Auto Controller Power Cord (included)

Repair Kits

See [Repair, page 58](#), for instructions on removal and installation.

Kit Number	Description
17H287	Main Board, <i>solventborne system only</i>
17H661	Main Board, <i>waterborne system only</i>
17H286	Power Board
17H285	Power Supply Board
17H283	Button Panel
17H282	LCD Panel

Accessories

Gun Power Cables

Part No.	Description
17H040	Gun Power Cable; 11 m (36 ft)
17H041	Gun Power Cable; 20 m (65.6 ft)
17H042	Gun Power Cable; 30 m (98.4 ft)

Mounting Brackets

Part No.	Description
17H288	Bracket, wall mounting, for 24Y307, 24Y308

Software

Part No.	Description
17B730	Software, main board
The software does not affect the portion of controller memory that defines the type of system.	

Dimensions

Controller

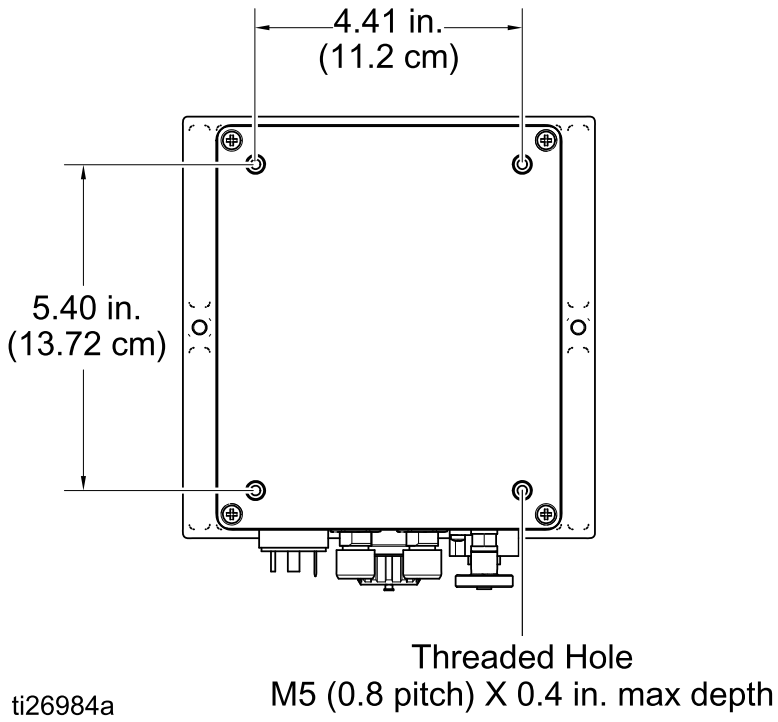
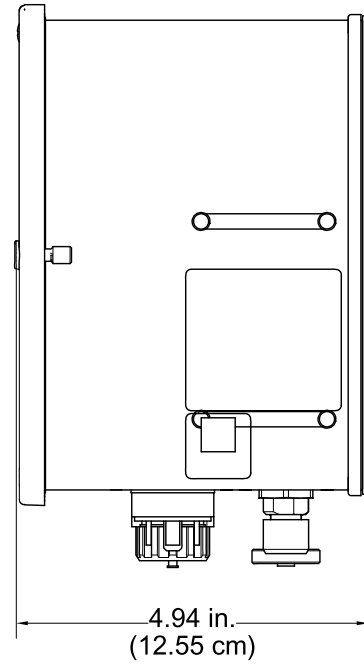
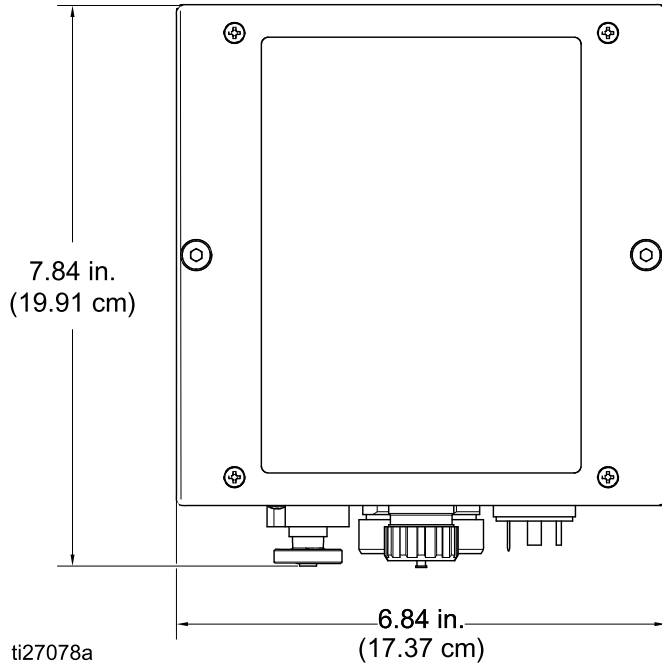

Flush Mount

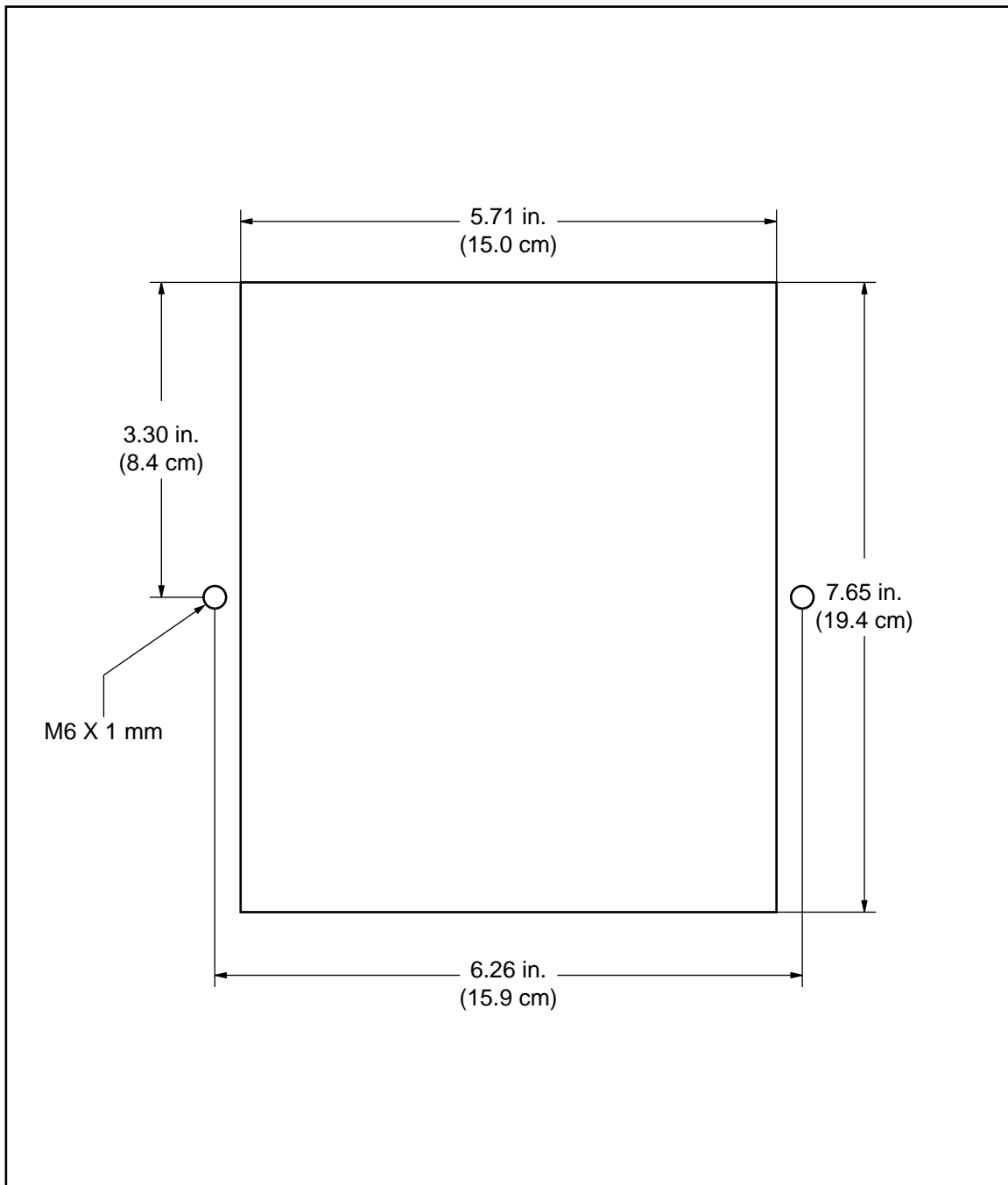

Dimensions

Wall Mount Bracket 17H288

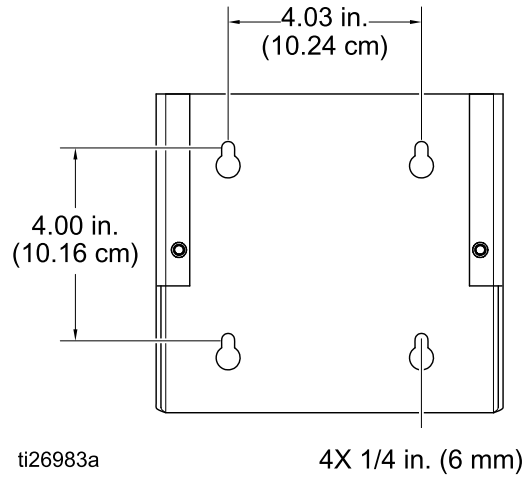

Technical Data

Pro Xpc Auto Controller		
	U.S.	Metric
Nominal Input Voltage	100–240 VAC	
Frequency	50–60 Hz	
Input Power	40 VA	
Nominal Output Voltage (to the gun)	eff 10V	
Nominal Output Current (to the gun)	max 1.2 A	
Protection Type	IP54	
Ambient Temperature Range	41°F - 104°F	5°C - 40°C
Dimensions		
Width	6.8 in.	173 mm
Depth	4.8 in.	122 mm
Height	7.5 in.	191 mm
Weight	approx. 4.5 lbs.	approx. 2.0 kg

Graco Standard Warranty

Graco warrants all equipment referenced in this document which is manufactured by Graco and bearing its name to be free from defects in material and workmanship on the date of sale to the original purchaser for use. With the exception of any special, extended, or limited warranty published by Graco, Graco will, for a period of twelve months from the date of sale, repair or replace any part of the equipment determined by Graco to be defective. This warranty applies only when the equipment is installed, operated and maintained in accordance with Graco's written recommendations.

This warranty does not cover, and Graco shall not be liable for general wear and tear, or any malfunction, damage or wear caused by faulty installation, misapplication, abrasion, corrosion, inadequate or improper maintenance, negligence, accident, tampering, or substitution of non-Graco component parts. Nor shall Graco be liable for malfunction, damage or wear caused by the incompatibility of Graco equipment with structures, accessories, equipment or materials not supplied by Graco, or the improper design, manufacture, installation, operation or maintenance of structures, accessories, equipment or materials not supplied by Graco.

This warranty is conditioned upon the prepaid return of the equipment claimed to be defective to an authorized Graco distributor for verification of the claimed defect. If the claimed defect is verified, Graco will repair or replace free of charge any defective parts. The equipment will be returned to the original purchaser transportation prepaid. If inspection of the equipment does not disclose any defect in material or workmanship, repairs will be made at a reasonable charge, which charges may include the costs of parts, labor, and transportation.

THIS WARRANTY IS EXCLUSIVE, AND IS IN LIEU OF ANY OTHER WARRANTIES, EXPRESS OR IMPLIED, INCLUDING BUT NOT LIMITED TO WARRANTY OF MERCHANTABILITY OR WARRANTY OF FITNESS FOR A PARTICULAR PURPOSE.

Graco's sole obligation and buyer's sole remedy for any breach of warranty shall be as set forth above. The buyer agrees that no other remedy (including, but not limited to, incidental or consequential damages for lost profits, lost sales, injury to person or property, or any other incidental or consequential loss) shall be available. Any action for breach of warranty must be brought within two (2) years of the date of sale.

GRACO MAKES NO WARRANTY, AND DISCLAIMS ALL IMPLIED WARRANTIES OF MERCHANTABILITY AND FITNESS FOR A PARTICULAR PURPOSE, IN CONNECTION WITH ACCESSORIES, EQUIPMENT, MATERIALS OR COMPONENTS SOLD BUT NOT MANUFACTURED BY GRACO. These items sold, but not manufactured by Graco (such as electric motors, switches, hose, etc.), are subject to the warranty, if any, of their manufacturer. Graco will provide purchaser with reasonable assistance in making any claim for breach of these warranties.

In no event will Graco be liable for indirect, incidental, special or consequential damages resulting from Graco supplying equipment hereunder, or the furnishing, performance, or use of any products or other goods sold hereto, whether due to a breach of contract, breach of warranty, the negligence of Graco, or otherwise.

FOR GRACO CANADA CUSTOMERS

The Parties acknowledge that they have required that the present document, as well as all documents, notices and legal proceedings entered into, given or instituted pursuant hereto or relating directly or indirectly hereto, be drawn up in English. Les parties reconnaissent avoir convenu que la rédaction du présente document sera en Anglais, ainsi que tous documents, avis et procédures judiciaires exécutés, donnés ou intentés, à la suite de ou en rapport, directement ou indirectement, avec les procédures concernées.

Graco Information

For the latest information about Graco products, visit www.graco.com. For patent information, see www.graco.com/patents.

To place an order, contact your Graco Distributor or call to identify the nearest distributor.

Phone: 612-623-6921 **or Toll Free:** 1-800-328-0211 **Fax:** 612-378-3505

All written and visual data contained in this document reflects the latest product information available at the time of publication.

Graco reserves the right to make changes at any time without notice.

Original Instructions. This manual contains English, MM 333266

Graco Headquarters: Minneapolis

International Offices: Belgium, China, Japan, Korea

GRACO INC. AND SUBSIDIARIES • P.O. BOX 1441 • MINNEAPOLIS, MN 55440-1441 • USA

Copyright 2015, Graco Inc. All Graco manufacturing locations are registered to ISO 9001.

www.graco.com
Revision H, June 2016