

Miniature MeterFlo® Pump Packages

DESCRIPTION

Miniature MeterFlo is an electric, motor-driven pump package with a series of pumping units designed for use with virtually any type of lube system requiring oil flow up to 14 in³/minute (229cc/min.). Each of these lube packages consists of a 115 VAC, 60Hz motor direct coupled to a gear pump and mounted on a steel reservoir. A wide range of displacements, reservoir sizes, and optional accessories are available. In continuous duty, these pump assemblies are rated for service up to 1,000 psi (69 bar).

FEATURES

- Nominal displacements of 1,5,8, and 14 in³/min. (16, 82, 131, and 229 cc/mm.)
- An adjustable internal relief protects pump from excessive pressures. Factory set at 1,000 psi (69 bar)
- Reservoirs with removable covers, sized at 1.5, 3, and 5 gallons (5.7, 11.4, and 18.9 liters)
- Reservoir has a suction line strainer, return line port, visual level gauge, pressure gauge and filler/strainer with spring return cap
- Options include low level switch, high pressure indicator, and lube cycle timer

OPERATION

The motor/pump assembly on a Miniature MeterFlo package runs continuously whenever power is applied. On/off cycles are available by using the optional timer that has user selectable off and on times. Optional low level and high pressure switches can be wired to warning lamps on an operator's panel, or to a central control room.



APPLICATIONS

A Miniature MeterFlo package is ideal for smaller series progressive systems requiring continuous metered lubrication with an electrically driven pump. Combined with Trabon® MSP flow controls and/or cycle switch assemblies, a Miniature MeterFlo package can be operated on a timed cycle for precision lubrication. This can be accomplished by returning unused flow to tank through an MSP® shunt valve after the lube requirements of the system have been met. Another alternative is to use cycle switch contacts in a latching relay circuit to keep the pump on until lube requirements of the system are satisfied.

In an orifice system, Miniature Meterflo can be operated in either continuous or timed mode. Usually, precision metering is not a criteria in this type of system.

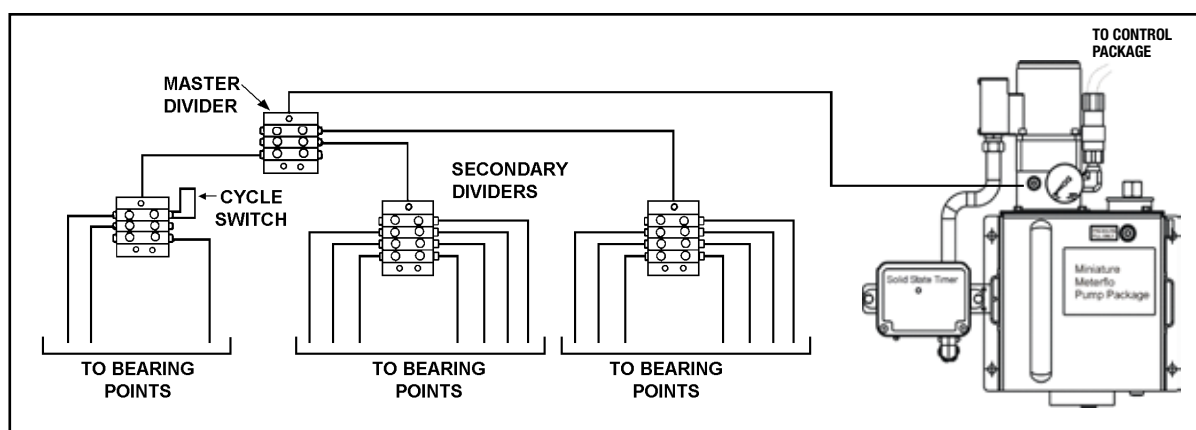

Figure 1.

SPECIFICATIONS	
PUMP ASSEMBLY:	
Motor Voltage	115 ± 10% VAC, 0.67A, 40W, 60 Hz
Motor Power (thermally protected)	1/19 HP
Motor Speed (before gear reduction)	1500 RPM
Pump Displacement	See Figures 2a - 2d
Pump Pressure Rate	see pump option, page 4
Relief Valve	300-2000 psi (21-138 bar), Factory set @ 1000 psi (69 bar)
Suction Strainer	140 micron stainless steel mesh
Pressure Gauge	0-1500 psi (0-100 bar)
Housing Materials	Painted Steel
Electrical Connections	3 Wire Hook-Up Inside Junction Box
RESERVOIR ASSEMBLY:	
Volume	See Table 1
Reservoir Materials	
Tank	Painted Steel
Level Gauge	Clear Nylon
OPTIONS:	
Low Level Switch Part No. 563014 (456-010-171)	
Actuator	Float Assembly
Contacts	Supplied N.C., Held Open, Rotate Float for N.O.
Max Contact Rate (resistive load)	0.30 amps @ 24 VDC
High Pressure Switch Part No. 557828 (542-210-107)	
Actuator	Diaphragm
Contacts	N.O. and N.C.
Contact Rate (inductive load)	0.3 amps
Pressure Range	400-4700 psi (38-324 bar) Factory set @ 750 psi (52 bar)
Controller Part No. 562872 (163-400-000)	115 VAC Solid-State Timer (see Bulletin L14521)

PUMP FLOW DATA

Note: All graphs are based on tests at 70°F at 10% and continuous duty cycles.

- A = 10 Wt. (160 sus) Oil**
- B = 40 Wt. (2,500 sus) Oil**
- C = 70 Wt. (15,000 sus) Oil**

Figure 2a.

PUMP OPTION "PA"
1 in³/min

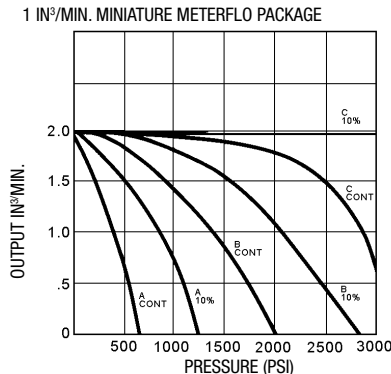

Figure 2b.

PUMP OPTION "PB"
5 in³/min

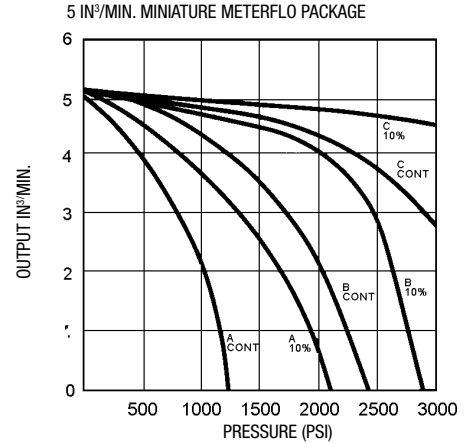

Figure 2c.

PUMP OPTION "PC"
8 in³/min

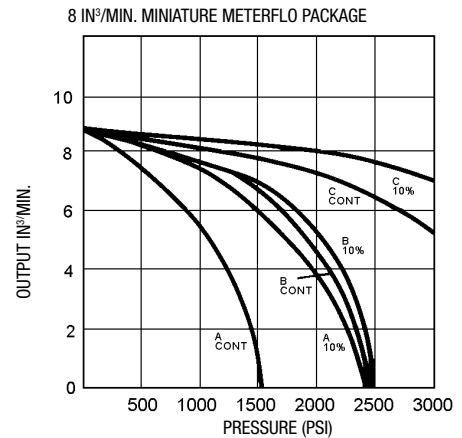
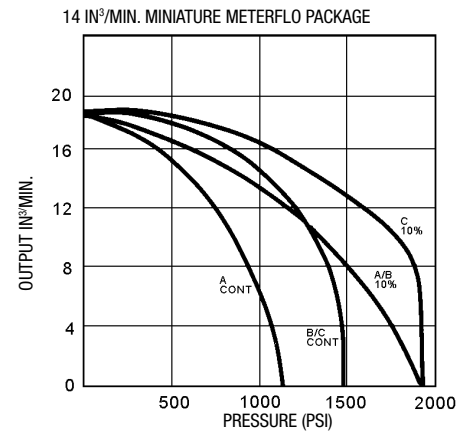

Figure 2d.

PUMP OPTION "PD"
14 in³/min



PUMP SELECTION

The gear pumps being supplied in the Miniature MeterFlo packages are "wet" gear pumps, meaning there is some inherent leakage at the gear housing. This is more evident with low viscosity oils than with high viscosity oils. In order to correctly size pump output to meet system requirements, one must know lubricant viscosity, duty cycle and approximate operating pressure. With these parameters and the Figure 2 output graphs on page 2, the proper pump can be selected. Outputs at different duty cycles can be estimated by sketching intermediate curves of the same general shape on these graphs.

INSTALLATION DATA

Mounting

The entire lube package is installed with four 3/8" screws that pass through holes in two mounting flanges on the rear of the reservoir. Mounting dimensions are given in Figure 3.

Inches (mm)

Figure 3.

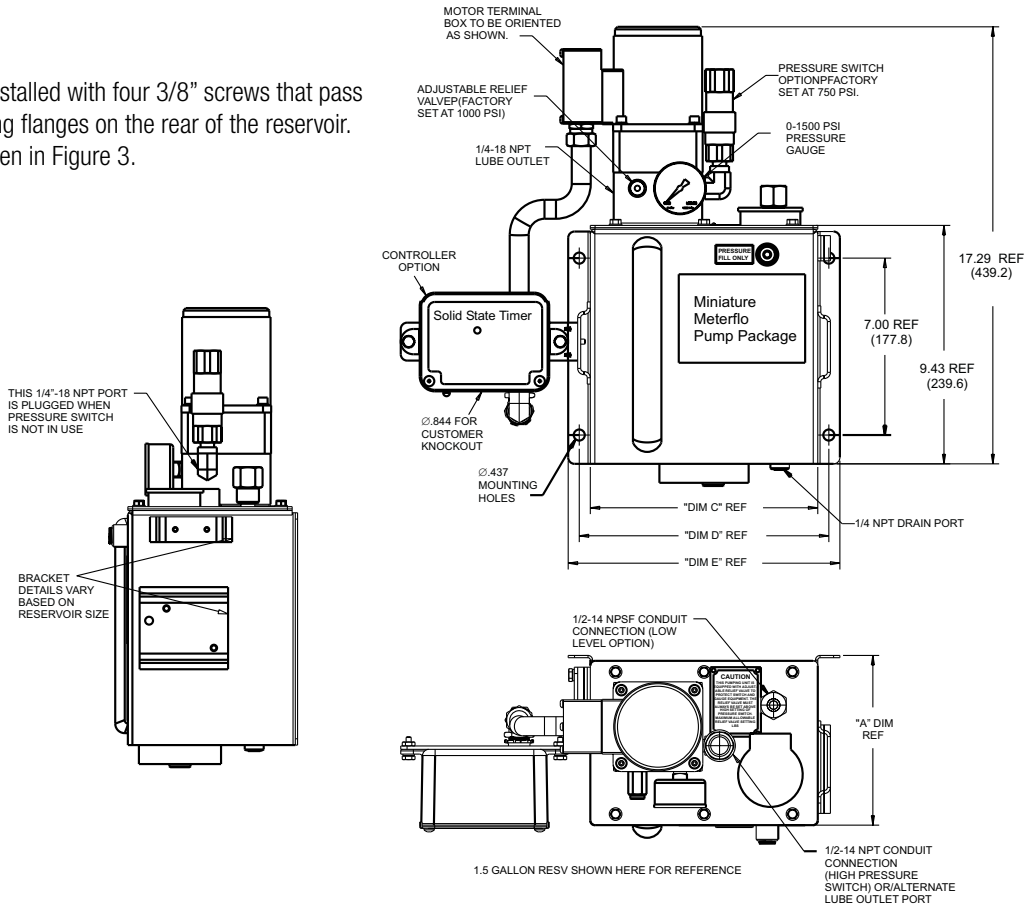

RESERVOIR SIZE	"A" DIM.	"B" DIM.	"C" DIM.	"D" DIM.	"E" DIM.
1.5 GALLON (5.7 LITERS)	6.75 (171.4)	3.35 (85.2)	9.00 (228.6)	9.87 (250.8)	10.75 (273.0)
3 GALLON (11.4 LITERS)	12.72 (323.0)	3.79 (96.3)	10.25 (260.3)	11.12 (282.6)	12.00 (304.8)
5 GALLON (19 LITERS)	12.72 (323.0)	3.79 (96.3)	15.50 (393.7)	16.37 (415.9)	17.25 (438.1)

Priming

The pump will prime itself whenever the reservoir is at least half full.

Electrical Hookup

Figure 4 is a simplified schematic for the entire pumping unit with all options shown. The electrical hookups are shown in Figures 5a.—5c. Wiring to the motor and optional switches should be with 16 AWG stranded wire and insulation rated for 115 VAC and 105°C. (If the timer option is used, connections are to a terminal strip inside the timer.)

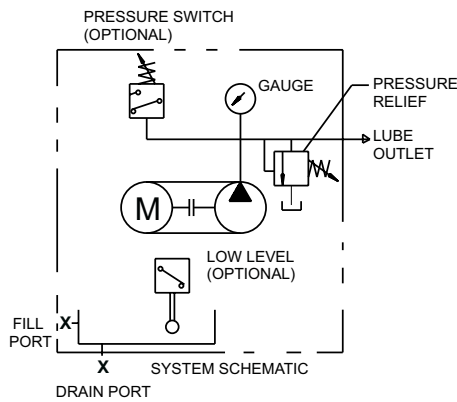

Figure 4

Figure 5a. Controller Wiring

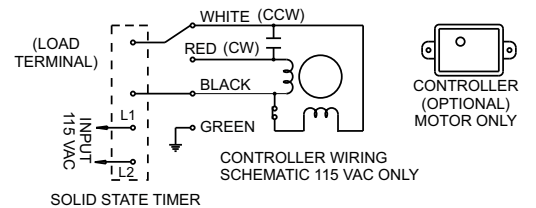

Figure 5b. Pressure Switch Wiring

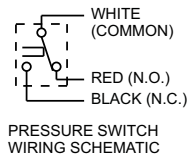
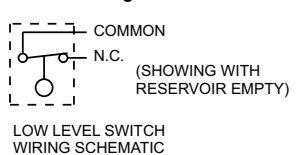

Figure 5c. Low Level Switch Wiring



MAINTENANCE INFORMATION

Normally, the only maintenance required on Miniature MeterFlo packages is filling the reservoir, and cleaning the suction strainer. Use only fresh, uncontaminated oil to fill the reservoir. Check the suction strainer annually, or more often if the pump is becoming noisy (cavitating) between cleanings. The suction strainer is accessed by removing the reservoir cover. It is also a good idea to periodically verify pump operation (lube delivery), the calibration of the timer settings and pressure switch setting, and the actuation depth of the low level switch, if these options are used.

SPARE PARTS ORDERING INFORMATION		
Description	Part No.	Old Part No.
Pump Assembly w/Motor, 1 in ³ /min	564412	540-800-610
Pump Assembly w/Motor, 5 in ³ /min	564413	540-800-620
Pump Assembly w/Motor, 8in ³ /min	564414	540-800-630
Pump Assembly w/Motor, SAE Ports, 8in ³ /min	–	540-801-045
Pump Assembly w/Motor, 14 in ³ /min	564415	540-800-640
Motor, 115 VAC	557286	493-040-065
Gear Box, 1 in ³ /min (12.5:1)	557293	493-060-007
Gear Box, 5 in ³ /min (5:1)	557292	493-060-006
Gear Box, 8 in ³ /min (3:1)	557291	493-060-005
Gear Box, 14 in ³ /min (3:1)	557291	493-060-005
Gear Pump Only, 1 to 8 in ³ /min	557822	540-800-603
Gear Pump Only, 14 in ³ /min	557821	540-800-430
115 VAC Solid-State Timer	562872	163-400-000
Pressure Switch	557828	542-210-107
Low Level Switch Assembly	563014	456-010-171
Suction Strainer	557810	540-666-008
Relief Valve	563558	540-835-100
Replacement Level Switch	557825	541-603-001

HOW TO ORDER

NOTE: Utilize number code not lettered code for ordering purposes.

MM – X – X – X – X

Reservoir Option

- 1 RA, 1.5 gallon reservoir
- 2 RB, 3 gallon reservoir
- 3 RC, 5 gallon reservoir

Pump / Flow Option (*)

- 1 PA, 1 cu.in. / minute (1,500 psi maximum operating pressure)
- 2 PB, 5 cu.in. / minute (2,000 psi maximum operating pressure)
- 3 PC, 8 cu.in. / minute (2,000 psi maximum operating pressure)
- 4 PD, 14 cu.in. / minute (1,500 psi maximum operating pressure)

Pressure Switch Option

- 1 SO, no pressure switch
- 2 SA, high pressure switch

Low Level Option

- 1 LO, no low level switch
- 2 LA, low level switch, reed-type, SPST - 563014

(*) All pump flow rates are based on 160 SUS (at 100 F) 10W oil, 70 F at 1,000 psi.

Example: Miniature Meterflo (MM) pump package consisting of a 3 gallon reservoir, 5 cu.in./minute pump output, high pressure switch and low level switch. Ordering Code: MM2222

Contact us today!

To receive product information or talk with a Graco representative, call 800-533-9655 or visit us online at www.graco.com.

