

INSTRUCTIONS-PARTS LIST



307-046

Rev L
Supersedes K

This manual contains IMPORTANT
WARNINGS AND INSTRUCTIONS
READ AND RETAIN FOR REFERENCE

STAINLESS STEEL

AIRLESS SPRAY GUNS

5000 psi (350 bar) MAXIMUM WORKING PRESSURE

Model 208-327, Series H*

for light viscosity paints
0.037 in. (0.94 mm) orifice, two finger trigger
With Non-Reversing DripLess™ Tip Guard

Model 208-663, Series H*

for heavy viscosity paints
0.090 in. (2.3 mm) orifice, two finger trigger
With Non-Reversing DripLess™ Tip Guard

Model 208-664, Series H*

for heavy viscosity paints
0.090 in. (2.3 mm) orifice, four finger trigger
With Non-Reversing DripLess™ Tip Guard

Model 220-954, Series A

for heavy viscosity paints
0.090 in. (2.3 mm) orifice, two finger trigger
With Reverse-A-Clean™ IV DripLess™ Tip Guard
and 517 size SwitchTip™

Model 224-020, Series A

for zinc paints
0.090 in. (2.3 mm) orifice, two finger trigger
With Heavy Duty Reverse-A-Clean™ DripLess™ Tip Guard
and GHD-617 size Tip Cylinder

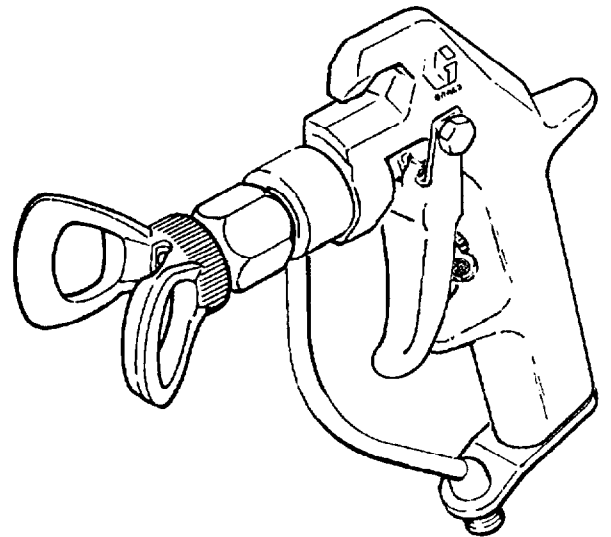

MODEL 208-663 SHOWN

* Spray tip not included. Must be ordered separately.

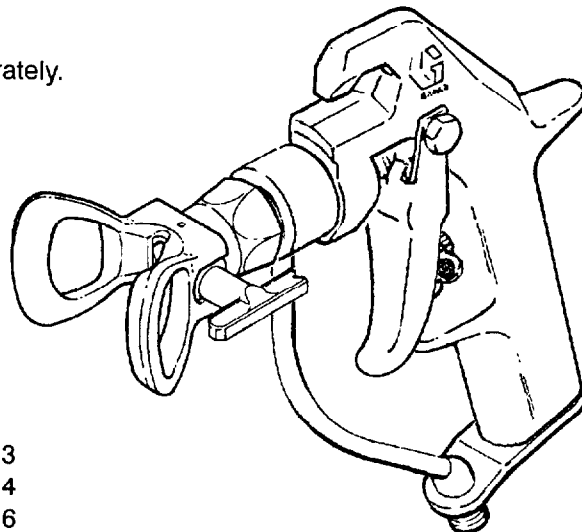

MODEL 220-954 SHOWN

TABLE OF CONTENTS

Warnings	2, 3
Installation	4
Operation	5, 6
Service	7
Parts Drawing and List	8, 9
Accessories	10
Technical Data	Back Cover
Warranty	Back Cover
Graco Toll-Free Phone Numbers ...	Back Cover

SAFETY WARNINGS

HIGH PRESSURE SPRAY CAN CAUSE SERIOUS INJURY. FOR PROFESSIONAL USE ONLY.

OBSERVE ALL WARNINGS. Read And Understand All Instruction Manuals Before Operating Equipment.

FLUID INJECTION HAZARD

General Safety

Airless spray equipment generates very high fluid pressure. Spray from the gun, leaks or ruptured components can inject fluid through your skin and into your body and cause extremely serious bodily injury, including the need for amputation. Also, fluid injected or splashed into the eyes or on the skin can cause serious damage.

NEVER point the spray gun at anyone or at any part of the body. NEVER put hand or fingers over the spray tip. NEVER try to "blow back" paint; this is NOT an air spray gun.

ALWAYS have the tip guard in place on the spray gun when spraying.

ALWAYS follow the **Pressure Relief Procedure**, right, before cleaning or removing the spray tip or servicing any system equipment.

NEVER try to stop or deflect leaks with your hand or body.

Be sure equipment safety devices are operating properly before each use.

Medical Alert--Airless Spray Wounds

If any fluid appears to penetrate your skin, get **EMERGENCY MEDICAL CARE AT ONCE. DO NOT TREAT AS A SIMPLE CUT.** Tell the doctor exactly what fluid was injected.

Note to Physician: *Injection in the skin is a traumatic injury. It is important to treat the injury surgically as soon as possible. Do not delay treatment to research toxicity. Toxicity is a concern with some exotic coatings injected directly into the blood stream. Consultation with a plastic surgeon or reconstructive hand surgeon may be advisable.*

Spray Gun Safety Devices

Be sure all spray gun safety devices are operating properly before each use. Do not remove or modify any part of the spray gun; this can cause a malfunction and result in serious bodily injury.

Safety Latch

Whenever you stop spraying, even for a moment, always set the spray gun safety latch in the closed or **ON SAFE** position, making the spray gun inoperative. Failure to set the safety latch can result in accidental triggering of the spray gun. See Fig 2, page 5.

Diffuser

The spray gun diffuser breaks up spray and reduces the risk of fluid injection when the tip is not installed. Check the diffuser operation regularly. Follow the **Pressure Relief Procedure**, at right, then remove the spray tip. Aim the spray gun into a grounded metal pail, holding the spray gun firmly to the pail. Using the lowest possible pressure, trigger the spray gun. If the fluid emitted is not diffused into an irregular stream, replace the diffuser immediately.

EQUIPMENT MISUSE HAZARD

General Safety

Any misuse of the spray equipment or accessories, such as overpressurizing, modifying parts, using incompatible chemicals and fluids, or using worn or damaged parts, can cause them to rupture and result in fluid injection, splashing in the eyes or on the skin, or other serious bodily injury, or fire, explosion or property damage.

NEVER alter or modify any part of this equipment; doing so could cause it to malfunction.

CHECK all spray equipment regularly and repair or replace worn or damaged parts immediately.

Always wear protective eyewear, gloves, clothing and respirator as recommended by the fluid and solvent manufacturer.

Tip Guard

ALWAYS have the tip guard in place on the spray gun while spraying. The tip guard alerts you to the fluid injection hazard and helps reduce, **but does not prevent**, the risk of accidentally placing your fingers or any part of your body close to the spray tip.

Trigger Guard

NEVER operate the gun with the trigger guard removed. The trigger guard reduces the risk of accidentally triggering the gun if it is dropped or bumped.

Spray Tip Safety

Use extreme caution when cleaning or changing spray tips. If the spray tip clogs while spraying, engage the spray gun safety latch immediately. ALWAYS follow the **Pressure Relief Procedure**, below, and then remove the spray tip to clean it.

NEVER wipe off build-up around the spray tip until pressure is fully relieved and the spray gun safety latch is engaged.

Pressure Relief Procedure

To reduce the risk of serious bodily injury, including fluid injection, splashing in the eyes or on the skin, or injury from moving parts, always follow this procedure whenever you shut off the spray equipment, when checking or servicing any part of the spray system, when installing, cleaning or changing spray tips, and whenever you stop spraying.

1. Engage the spray gun safety latch.
2. Shut off the power supply to the pump.
3. In air-powered systems, close any bleed-type master air valves in the air supply.
4. Disengage the spray gun safety latch.
5. Hold a metal part of the spray gun firmly to the side of a grounded metal pail, and trigger the gun to relieve pressure.
6. Engage the spray gun safety latch.
7. Open the pump fluid drain valve (required in your system), having a container ready to catch the drainage.
8. Leave the drain valve open until you are ready to spray again.

If you suspect that the spray tip or hose is completely clogged, or that pressure has not been fully relieved after following the steps above, VERY SLOWLY loosen the tip guard retaining nut or hose end coupling and relieve pressure gradually, then loosen completely. Now clear the tip or hose.

System Pressure

NEVER exceed 5000 psi (350 bar) **MAXIMUM WORKING PRESSURE** to the gun. Be sure that all accessories and system components are rated to withstand the pressures developed. NEVER exceed the maximum working pressure of any component or accessory used in the system.

Fluid Compatibility

BE SURE that all fluids and solvents used are chemically compatible with the wetted parts shown in the **TECHNICAL DATA** on the back cover. Always read the manufacturer's literature before using fluid or solvent in the system.

HOSE SAFETY

High pressure fluid in the hoses can be very dangerous. If the hose develops a leak, split or rupture due to any kind of wear, damage or misuse, the high pressure spray emitted from it can cause a fluid injection injury or other serious bodily injury or property damage.

ALL FLUID HOSES MUST HAVE SPRING GUARDS ON BOTH ENDS! The spring guards help protect the hose from kinks or bends at or close to the coupling which can result in hose rupture.

TIGHTEN all fluid connections securely before each use. High pressure fluid can dislodge a loose coupling or allow high pressure spray to be emitted from the coupling.

NEVER use a damaged hose. Before each use, check the entire hose for cuts, leaks, abrasion, bulging cover, or damage or movement of the hose couplings. If any of these conditions exist, replace the hose immediately. **DO NOT** try to recouple high pressure hose or mend it with tape or any other device. A repaired hose cannot safely contain the high pressure fluid.

HANDLE AND ROUTE HOSES CAREFULLY. Do not pull on hoses to move equipment. Do not use fluids which are not compatible with the inner tube and cover of the hose. **DO NOT** expose Graco hoses to temperatures above 180° F (82° C) or below -40° F (-40° C).

FIRE OR EXPLOSION HAZARD

Static electricity is created by the flow of fluid through the pump and hose. If every part of the spray equipment is not properly grounded, sparking may occur, and the system may become hazardous. Sparking may also occur when plugging in or unplugging a power supply cord. Sparks can ignite fumes from solvents and the fluid being sprayed, dust particles and other flammable substances, whether you are spraying indoors or outdoors, and can cause a fire or explosion and serious bodily injury and property damage. Do not plug in or unplug any power supply cords in the spray area when there is any chance of igniting fumes still in the air.

If you experience any static sparking or even a slight shock while using this equipment, **STOP SPRAYING IMMEDIATELY.** Check the entire system for proper grounding. Do not use the system again until the problem has been identified and corrected.

Grounding

To reduce the risk of static sparking, ground the pump, object being sprayed, and all other spray equipment used or located in the spray area. **CHECK** your local electrical code for detailed grounding instructions for your area and type of equipment. **BE SURE** to ground all of this spray equipment:

1. *Pump or sprayer:* as instructed in your separate pump or sprayer manual.
2. *Air compressor or hydraulic power supply:* follow manufacturer's recommendations.
3. *Fluid hoses:* use only grounded hoses with a maximum of 500 feet (150 m) combined hose length to ensure grounding continuity. Refer also to **Hose Grounding Continuity**, above.

Hose Grounding Continuity

Proper hose grounding continuity is essential to maintaining a grounded spray system. Check the electrical resistance of your air and fluid hoses at least once a week. If your hose does not have a tag on it which specifies the maximum electrical resistance, contact the hose supplier or manufacturer for the maximum resistance limits. Use a resistance meter in the appropriate range for your hose to check the resistance. If the resistance exceeds the recommended limits, replace it immediately. An ungrounded or poorly grounded hose can make your system hazardous. Also, read **FIRE OR EXPLOSION HAZARD**, below.

MOVING PARTS HAZARD

Moving parts can pinch or amputate your fingers or other body parts. **KEEP CLEAR** of moving parts when starting or operating your system. Before checking or servicing the pump or any system component, follow the **Pressure Relief Procedure** on page 2, to prevent the pump from starting accidentally.

4. *Spray gun:* grounding is obtained through connection to a properly grounded fluid hose and pump or sprayer.
5. *Object being sprayed:* according to your local code.
6. *Fluid supply container:* according to your local code.
7. *All solvent pails used when flushing,* according to local code. Use only metal pails, which are conductive, placed on a grounded surface. Do not place the pail on a nonconductive surface, such as paper or cardboard, which interrupts the grounding continuity.
8. *To maintain grounding continuity when flushing or relieving pressure,* always hold a metal part of the spray gun firmly to the side of a grounded metal pail, then trigger the spray gun.

Flushing Safety

Before flushing, be sure the entire system and flushing pails are properly grounded. Refer to **Grounding**, at the left. Follow the **Pressure Relief Procedure** on page 2, and *remove the spray tip from the spray gun.* Always use the lowest possible fluid pressure, and maintain firm metal-to-metal contact between the spray gun and the pail during flushing to reduce the risk of fluid injection injury, static sparking and splashing.

TERMS

WARNING: Alerts user to avoid or correct conditions that could cause bodily injury.

CAUTION: Alerts user to avoid or correct conditions that could damage the equipment.

NOTE: Gives special procedures or information.

IMPORTANT

United States Government safety standards have been adopted under the Occupational Safety and Health Act. These standards – particularly the General Standards, Part 1910, and the Construction Standards, Part 1926 – should be consulted.

INSTALLATION

NOTE: Reference numbers and letters in parentheses in the text refer to the callouts in the figures and the parts drawing.

WARNING

Two accessories are required in your system: a bleed-type master air valve (pneumatic pumps only) and a fluid drain valve. These accessories help reduce the risk of serious bodily injury including fluid injection, splashing in the eyes or on the skin, and injury from moving parts if you are adjusting or repairing the pump or gun.

The *bleed-type master air valve* relieves air trapped between this valve and the pump after the air regulator is shut off. Trapped air can cause the pump to cycle unexpectedly. Locate the valve close to the pump, downstream from the air regulator.

The *fluid drain valve* assists in relieving fluid pressure in the displacement pump, hose, and gun. Triggering the gun to relieve pressure may not be sufficient.

1. Connect a grounded fluid hose (C) to the gun inlet (B). See Fig 1.
2. With no tip installed, start the pump/sprayer. Flush it according to the instructions supplied with it. Prime the sprayer with the fluid you are using.
3. Follow the **Pressure Relief Procedure** on page 2.

4. *Models 220-954 and 224-020 only:* refer to the supplied instructions for Reverse-A-Clean (24 or 26) installation and operation procedures.

All other models: with the gun safety latch (11) engaged, unscrew the tip guard (18) and install the tip (A) and gasket (7) in the nut of the tip guard. Screw the assembly firmly onto the gun. Tighten with a wrench. See Fig 1.

NOTE: Failure to install the tip gasket (7) when using a flat tip (only) will result in leaking.

5. Strain the fluid you are spraying if it contains particles which could clog the spray tip.

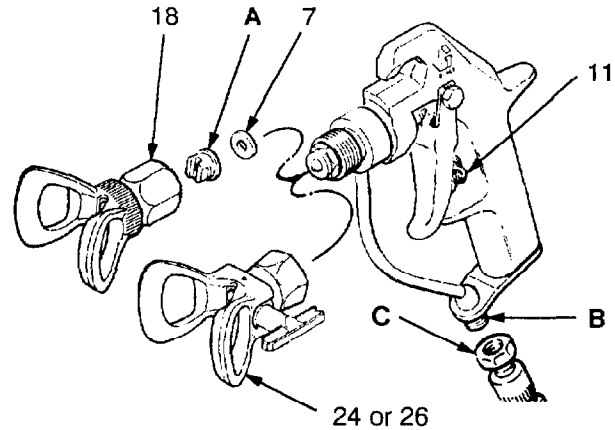

Fig 1

OPERATION

WARNING

To reduce the risk of serious bodily injury, including fluid injection or splashing in the eyes or on the skin, always follow the **Pressure Relief Procedure** on page 2 before checking, servicing, installing, removing, changing or cleaning spray tips or any part of the gun or system.

Whenever you stop spraying for a moment, engage the gun safety latch. See Fig 2.

WARNING

The wallet-sized warning card provided with this gun should be kept with the operator at all times. The card contains important treatment information should a fluid injection injury occur. Additional cards are available at no charge from Graco, Inc.

1. Start the pump according to the instructions in the separate pump manual. Adjust the fluid pressure so the spray is completely atomized. Always use the lowest pressure necessary to get the desired results. Higher pressure may not improve the spray pattern and will cause premature tip and pump wear.
2. If adjusting the pressure does not give a good spray pattern, try another tip size. Be sure to follow the **Pressure Relief Procedure** on page 2 before changing tips.
3. Use a full-open, full-close trigger action. Hold the gun about 14 in. (350 mm) from and at right angles to the work surface. Do not swing the gun in an arc. Practice to find the best length and speed of stroke.

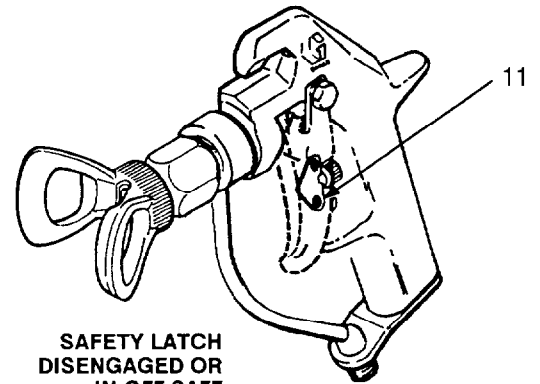

SAFETY LATCH
DISENGAGED OR
IN OFF SAFE
POSITION

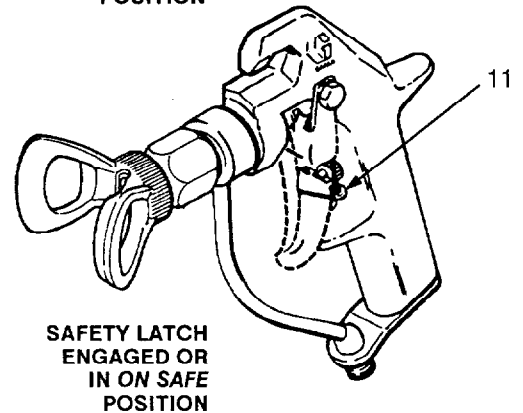

SAFETY LATCH
ENGAGED OR
IN ON SAFE
POSITION

Fig 2

OPERATION

Adjust the Spray Pattern

1. To adjust the spray pattern direction, follow the **Pressure Relief Procedure** on page 2. Engage the safety latch and loosen the tip guard retaining nut. Turn the spray tip so the groove is horizontal for a horizontal spray pattern, and vertical for a vertical spray pattern. Tighten the nut.
2. The spray tip orifice size and spray angle determines the coverage and size of pattern. When more coverage is needed, use a larger spray tip rather than increasing fluid pressure.

WARNING

To reduce the risk of a fluid injection injury, NEVER use the gun with the tip guard removed.

CAUTION

Openings in the tip guard are designed to reduce paint buildup on the guard while spraying. Any damage to the sharp edges of the openings causes paint to collect at that area. To reduce the risk of damage, never hang the gun by the tip guard.

Cleaning and Clearing the Spray Tip

WARNING

To reduce the risk of fluid injection or splashing in the eyes or on the skin, DO NOT hold your hand, body, or a rag in front of the spray tip when cleaning or checking a clogged tip. Always point the gun toward the ground or into a waste container when checking to see if the spray tip is cleared.

DO NOT try to "blow back" paint; this is NOT an air spray gun.

DO NOT wipe fluid buildup off the gun or spray tip until pressure is relieved. See the **Pressure Relief Procedure** on page 2.

Clean off the front of the tip frequently during the day's operation and at the end of the workday. Always follow the **Pressure Relief Procedure** on page 2. Then use a solvent soaked brush to clean the spray tip and to keep fluid buildup from drying and clogging the spray tip.

If the spray tip clogs while spraying, release the spray gun trigger, engage the trigger safety, shut off the pump, and follow the **Pressure Relief Procedure** on page 2. Then remove the spray tip and blow out the obstruction with air from the front of the spray tip, or let the spray tip and gun nozzle soak long enough to dissolve the obstruction. If it won't dissolve, jar it out by tapping the back of the spray tip against a flat surface.

CAUTION

NEVER soak the entire gun in solvent. Prolonged exposure to solvent can ruin the packings.

Flushing the Gun

WARNING

Before flushing, be sure the entire system and flushing pails are properly grounded. Refer to **Grounding**, on page 3. Follow the **Pressure Relief Procedure** on page 2, and *remove the spray tip from the gun*. Always use the lowest possible fluid pressure, and maintain firm metal-to-metal contact between the gun and the pail during flushing to reduce the risk of a fluid injection injury, static sparking and splashing.

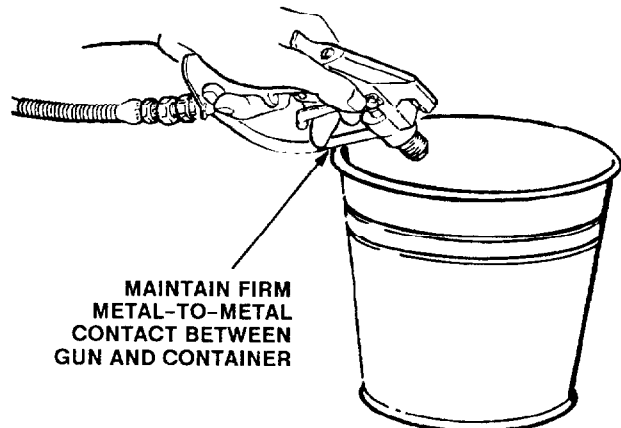

Fig 3

Relieve pressure, remove the spray tip, and then flush the gun and spray system with a compatible solvent. Always flush the gun before the fluid being sprayed can dry in it.

WARNING

To reduce the risk of serious bodily injury, including fluid injection, and splashing fluid in the eyes or on the skin, always follow the **Pressure Relief Procedure** on page 2 before adjusting, cleaning or repairing the gun.

Periodically disassemble the gun to clean and inspect parts. Clean all parts thoroughly, and check them carefully for damage or wear. Replace parts as needed.

If your gun leaks at the tip when you release the trigger, the needle or seat is worn or damaged and must be replaced. See page 8 for available repair kits. Parts included in the repair kits are marked with a double asterisk, for example (5**).

Needle Replacement (See Fig 4 and Parts Drawing)

NOTE: Part No. 178-481 Tool is available for removing and installing a needle without complete disassembly of the gun, and without damaging the needle. This section tells you how to use the tool when you are replacing only the needle. However, it can be used when you are disassembling the entire gun.

Disassembly

1. Follow the **Pressure Relief Procedure** on page 2. Disconnect the hose. Remove the tip guard, spray spray tip, and gasket. Remove the screw (10), pivot pin (6) and trigger (8). Remove the plug (4) at the rear of the gun. Remove the diffuser-seat (16).
2. Insert the narrow end of tool 178-481 through the rear of the gun and push out the needle (19). A rubber mallet may be required.

Reassembly

1. Lubricate the o-ring (D) and ring (E) of the new needle assembly (19**) with lightweight oil.
2. Place the pointed end of the needle into the large end of the tool. Guide the rear of the needle through the front of the gun until the trigger flats are exposed.
3. With new gasket (5**) in place, screw the new diffuser-seat (16**) into the fluid housing. Torque to 20-25 ft-lb (27-34 N.m).
4. Install the trigger (8), pivot pin (6) and screw (10). **DO NOT** install the plug (4) yet!
5. Adjust the needle before operating the gun. See next paragraph.

Adjusting the Needle

WARNING

Proper adjustment of the needle is essential to be sure the trigger safety latch makes the gun inoperative when engaged. Improper adjustment may allow the gun to be triggered, even with the trigger safety latch engaged, resulting in serious bodily injury, including fluid injection, and splashing in the eyes or on the skin.

1. Hold the gun with the nozzle straight up so the trigger falls onto the safety latch. Insert a flat blade screw-

driver into the rear port of the gun until it engages with the slot (F) at the back of the needle. See Fig 5.

NOTE: If the trigger does not touch the latch, turn the needle clockwise until it does.

2. With light pressure, hold the trigger against the latch. Turn the needle counterclockwise until there is enough tension for you to **feel** and **see** the trigger raise slightly off the latch.
3. Now turn the needle back 3/4 turn.
4. Install the plug (4).
5. Connect the fluid hoses and start the pump. Release the trigger safety latch and trigger the gun into a grounded waste container. Release the trigger; the fluid should stop flowing immediately. Now engage the safety again and try to trigger the gun; no fluid should flow. **If the gun failed either test**, follow the **Pressure Relief Procedure** on page 2, disconnect the hoses, and adjust the needle again.
6. Place the tip (A) and new gasket (7**) in the nut of the tip guard. Screw the assembly firmly onto the gun. Tighten with a wrench.

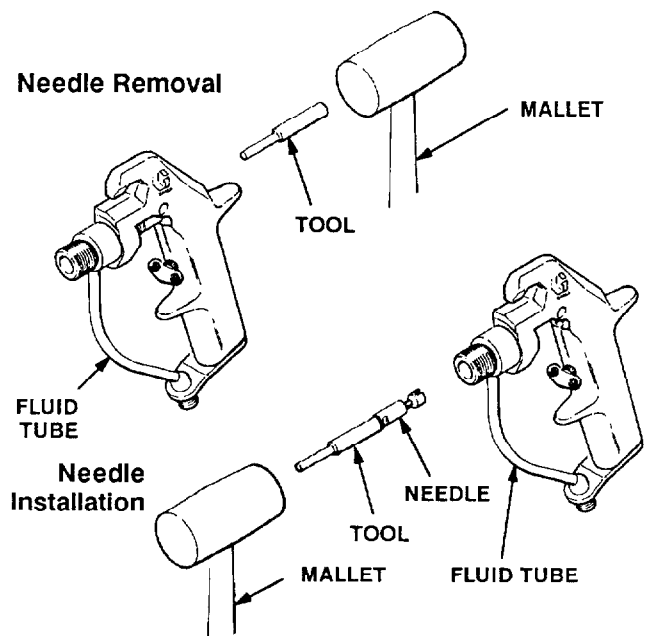

Fig 4

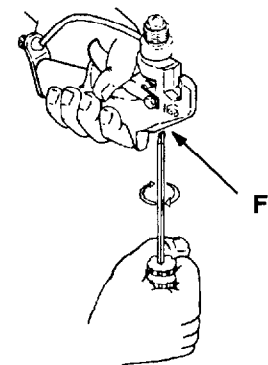

Fig 5

PARTS DRAWING

Model 208-327, Series H
Includes items 1-23

Model 220-954, Series A
Includes items 1-6, 8-17, 19-25

Model 208-663, Series H
Includes items 1-23

Model 224-020, Series A
Includes items 1-6, 8-17, 19-23, 26-27

Model 208-664, Series H
Includes items 1-23

REPAIR KITS (Must be purchased separately)

218-143

For Models 208-663, 208-664, 220-954 and 224-020 only.
Consists of:

Ref. No.	Qty
5	1
7	1
16	1
19	1

214-975

For Model 208-327 only.
Consists of:

Ref. No.	Qty
5	1
7	1
16	1
19	1

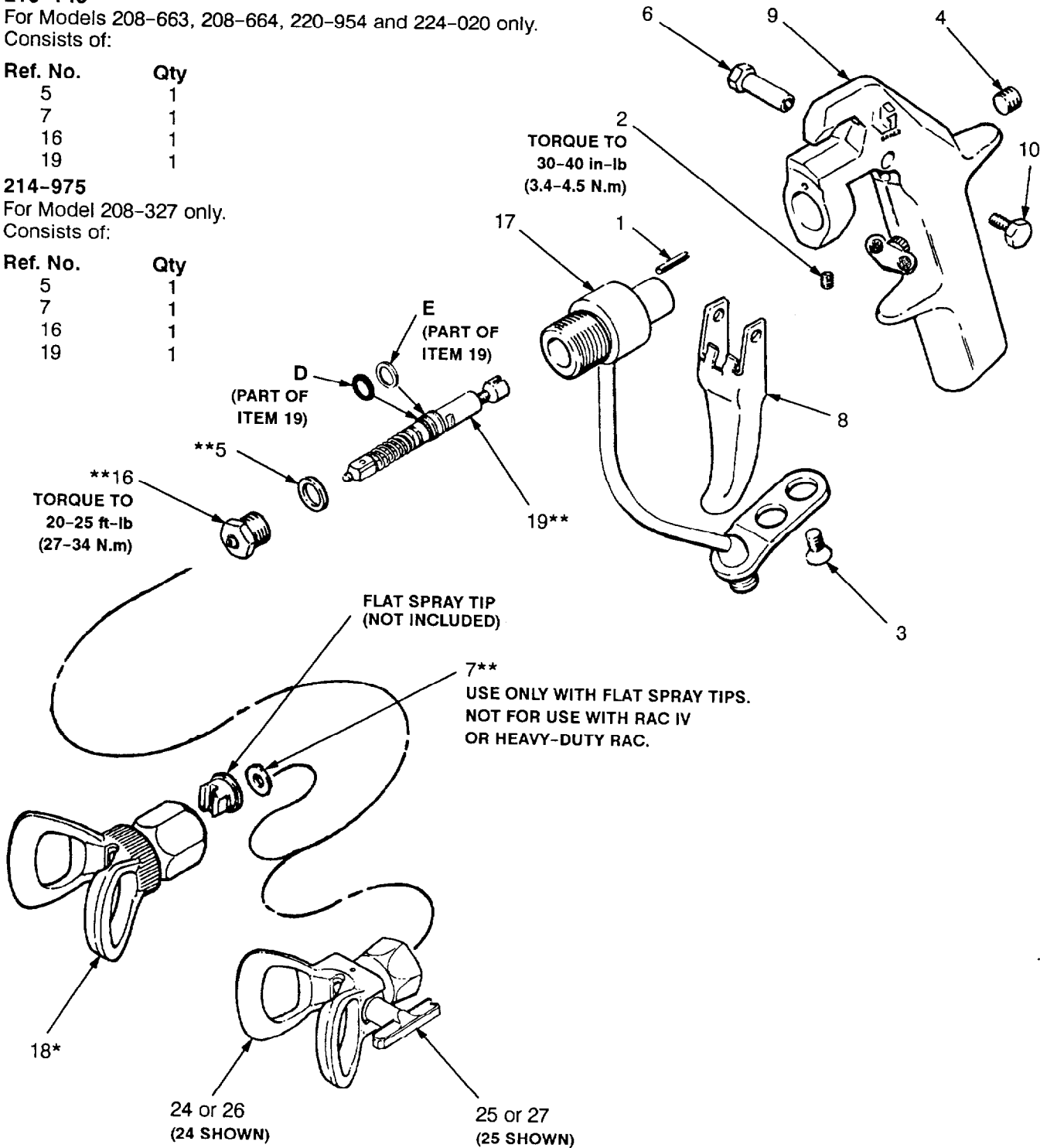

PARTS LIST

Model 208-327, Series H
Includes items 1-23

Model 208-663, Series H
Includes items 1-23

Model 208-664, Series H
Includes items 1-23

Model 220-954, Series A
Includes items 1-6, 8-17, 19-25

Model 224-020, Series A
Includes items 1-6, 8-17, 19-23, 26-27

REF NO.	PART NO.	DESCRIPTION	QTY
1	101-804	PIN, spring, straight	1
2	102-207	SETSCREW, socket hd cup pt; 1/4-20 x 1/4" (6 mm) long	1
3	107-091	SCREW, oval hd machine; 1/4-20 x 1/2" (13 mm) long	2
4	103-219	PLUG, screw	1
5	156-766**	GASKET; copper	1
6	160-217	PIN, pivot	1
7	166-969**	GASKET, flat; Delrin® (for flat tips only)	1
8	169-550	TRIGGER, gun (Models 208-327, 208-663, 220-954 and 224-020 only)	1
	180-145	TRIGGER, gun (Model 208-664 only)	1
9	218-181	BODY, gun	1
10	203-953	SCREW, lock	1
16	218-599**	DIFFUSER-SEAT (Model 208-327 only)	1
	214-967**	DIFFUSER-SEAT (Models 208-663, 208-664, 220-954 and 224-020 only)	1

REF NO.	PART NO.	DESCRIPTION	QTY
17	208-338	HOUSING, fluid (Models 208-327, 208-663, 220-954 and 224-020 only)	1
	208-802	HOUSING, fluid (Model 208-664 only)	1
18	220-251*	TIP GUARD	1
19	218-129**	NEEDLE ASSEMBLY	1
22	172-479†	TAG, warning (not shown)	1
23	179-960†	CARD, warning (not shown)	1
24	220-422	RAC IV DripLess™ Tip Guard See 307-848 for parts	1
25	221-517*	SPRAY TIP; 517 size SwitchTip™	1
26	222-674	HEAVY-DUTY RAC Tip Guard	1
27	GHD-617	SPRAY TIP; 617 size tip cylinder	1

* Recommended "tool box" spare parts. Keep on hand to reduce downtime.

** Included in Repair Kit (see page 8).

† Extra warning tags and cards available at no charge.

307 numbers in descriptions refer to separate instruction manuals.

HOW TO ORDER PARTS

1. To be sure you receive the correct replacement parts, kits or accessories, always give all of the information requested in the chart below.
2. Check the parts list to identify the correct part number; do not use the ref. no. when ordering.
3. Order all parts from your nearest Graco distributor.

6 digit Part Number	Qty	Part Description

SERVICE INFORMATION

Model 224-020 is added to the manual.

ACCESSORIES

USE GENUINE GRACO PARTS AND ACCESSORIES

Must be purchased separately.

REVERSE-A-CLEAN™ TIP GUARDS

5000 psi (350 bar) MAXIMUM WORKING PRESSURE

Uses fluid pressure to clear tip clogs. Unique tip guard resists paint buildup. Spray tip not included; order separately.

Model 220-422 RAC IV

Model 222-674 Heavy-Duty RAC

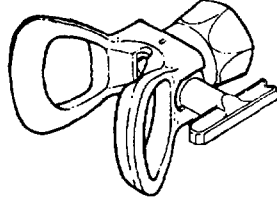

IN-LINE FILTER

5000 psi (350 bar) MAXIMUM WORKING PRESSURE

60 mesh (250 micron) screen.

213-068 Filter assembly

210-729 Filter 213-068, with 3 ft (0.9 m) whip hose

210-731 Includes three 60 mesh (250 micron) screens

210-732 Includes three 100 mesh (149 micron) screens

210-733 Includes three 200 mesh (74 micron) screens



SWIVELS

Use for more flexible gun movement.

Model 204-940 1/4 npt(m) x 1/4 npsm(f) [shown]
3000 psi (210 bar) MAXIMUM WORKING PRESSURE

Model 207-946 1/2 npsm(f) x 3/8 npt(f)
5000 psi (350 bar) MAXIMUM WORKING PRESSURE

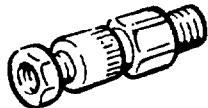

IN-LINE FILTER 210-500

3000 psi (210 bar) MAXIMUM WORKING PRESSURE

Install between gun and hose.

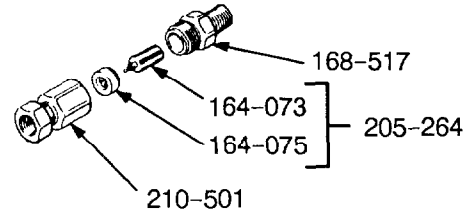

NYLON BRUSHES

101-891 0.375" (10 mm) dia.

101-892 0.625" (16 mm) dia.



DIRECTIONAL SPRAY NOZZLE ADAPTERS

3000 psi (210 bar) MAXIMUM WORKING PRESSURE

Tip filter and tip retainer nut included.

Model 206-235

Single nozzle swivels 180°, permits spray pattern direction to suit job.

Model 206-236

Dual nozzle for wider spray pattern or two spray patterns angled in opposite directions.

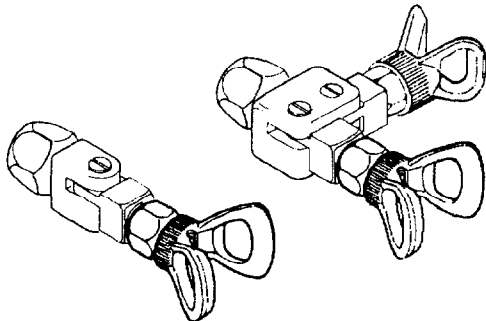

TIP WRENCH 171-147

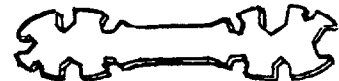

NEEDLE TOOL 178-481

For inserting and removing needle without requiring removal of fluid housing from gun. Also permits needle replacement from the front of the gun.

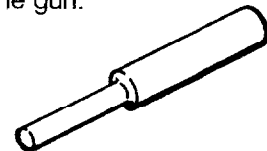

TECHNICAL DATA

Maximum working pressure	5000 psi (350 bar)
Fluid orifice	Models 208-663, 208-664, 220-954 and 224-020: .090 in. (2.3 mm) Model 208-327: .037 in. (0.94 mm)
Weight	21 oz (0.6 kg)
Height	7.25 in. (184 mm)
Length	8.25 in. (209 mm)
Fluid inlet	1/4 nsm(m)
Wetted parts	303 or 304 Stainless Steel, Tungsten Carbide, PTFE Delrin®, Polyurethane, Acetal Homopolymer

PTFE and Delrin®

THE GRACO WARRANTY AND DISCLAIMERS

WARRANTY

Graco warrants all equipment manufactured by it and bearing its name to be free from defects in material and workmanship on the date of sale by an authorized Graco distributor to the original purchaser for use. As purchaser's sole remedy for breach of this warranty, Graco will, for a period of twelve months from the date of sale, repair or replace any part of the equipment proven defective. This warranty applies only when the equipment is installed, operated and maintained in accordance with Graco's written recommendations.

This warranty does not cover, and Graco shall not be liable for, any malfunction, damage or wear caused by faulty installation, misapplication, abrasion, corrosion, inadequate or improper maintenance, negligence, accident, tampering, or substitution of non-Graco component parts. Nor shall Graco be liable for malfunction, damage or wear caused by the incompatibility with Graco equipment of structures, accessories, equipment or materials not supplied by Graco, or the improper design, manufacture, installation, operation or maintenance of structures, accessories, equipment or materials not supplied by Graco.

This warranty is conditioned upon the prepaid return of the equipment claimed to be defective to an authorized Graco distributor for verification of the claim. If the claimed defect is verified, Graco will repair or replace free of charge any defective parts. The equipment will be returned to the original purchaser transportation prepaid. If inspection of the equipment does not disclose any defect in material or workmanship, repairs will be made at a reasonable charge, which charges may include the costs of parts, labor and transportation.

DISCLAIMERS AND LIMITATIONS

THE TERMS OF THIS WARRANTY CONSTITUTE PURCHASER'S SOLE AND EXCLUSIVE REMEDY AND ARE IN LIEU OF ANY OTHER WARRANTIES (EXPRESS OR IMPLIED), INCLUDING WARRANTY OF MERCHANTABILITY OR WARRANTY OF FITNESS FOR A PARTICULAR PURPOSE, AND OF ANY NON-CONTRACTUAL LIABILITIES, INCLUDING PRODUCT LIABILITIES, BASED ON NEGLIGENCE OR STRICT LIABILITY. EVERY FORM OF LIABILITY FOR DIRECT, SPECIAL OR CONSEQUENTIAL DAMAGES OR LOSS IS EXPRESSLY EXCLUDED AND DENIED. IN NO CASE SHALL GRACO'S LIABILITY EXCEED THE AMOUNT OF THE PURCHASE PRICE. ANY ACTION FOR BREACH OF WARRANTY MUST BE BROUGHT WITHIN TWO (2) YEARS OF THE DATE OF SALE.

EQUIPMENT NOT COVERED BY GRACO WARRANTY

GRACO MAKES NO WARRANTY, AND DISCLAIMS ALL IMPLIED WARRANTIES OF MERCHANTABILITY AND FITNESS FOR A PARTICULAR PURPOSE, WITH RESPECT TO ACCESSORIES, EQUIPMENT, MATERIALS, OR COMPONENTS SOLD BUT NOT MANUFACTURED BY GRACO. These items sold, but not manufactured by Graco (such as electric motor, switches, hose, etc.) are subject to the warranty, if any, of their manufacturer. Graco will provide purchaser with reasonable assistance in making any claim for breach of these warranties.

IMPORTANT PHONE NUMBERS

TO PLACE AN ORDER, contact your Graco distributor, or call this number to identify the distributor closest to you:

1-800-328-0211 Toll Free

FOR TECHNICAL ASSISTANCE, service repair information or assistance regarding the application of Graco equipment: **1-800-543-0339 Toll Free**

Factory Branches: Atlanta, Chicago, Dallas, Detroit, Los Angeles, West Caldwell (N.J.)
Subsidiary and Affiliate Companies: Canada; England; Switzerland; France; Germany; Hong Kong; Japan

GRACO INC. P.O. BOX 1441 MINNEAPOLIS, MN 55440-1441

PRINTED IN U.S.A. 307-046 9-71 Revised 11-90