

OPERATION – FONCTIONNEMENT UTILIZAÇÃO – FUNCIONAMIENTO



309059

Rev. E
Rév. E

190ES™

– For portable spray applications of architectural paints
and coatings –

Models: 232900–232909; 233797; 233815

3000 psi (207 bar, 20.7 MPa) Maximum Working Pressure
Pression de service maximum 3000 psi (207 bar, 20.7 MPa)
Pressão máxima de trabalho de 3000 psi (207 bar, 20.7 MPa)
Presión máxima de funcionamiento de 3000 psi (207 bar, 20.7 MPa)

All models not available in all countries
Tous les modèles ne sont pas disponibles dans tous les pays
Nem todos os modelos se encontram disponíveis em todos os países
Hay modelos que no se distribuyen en todos los países

Related manuals
Manuels afférents
Manuais associados
Manuales relacionados

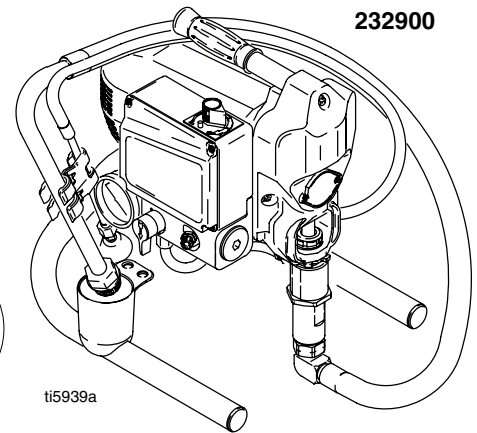
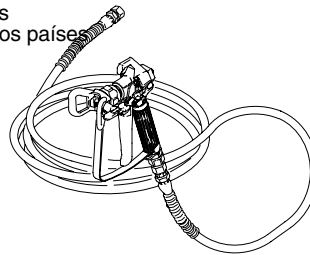

232900

ti5939a



..... 309063

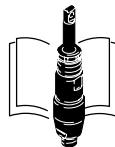

..... 309060



..... 309064



..... 309061
309097



..... 308644
309055



..... 309065

INSTRUCTIONS	INSTRUCTIONS
<p>READ ALL INSTRUCTIONS AND WARNINGS BEFORE SETTING UP OR OPERATING THIS UNIT.</p> <p>You need:</p> <ul style="list-style-type: none"> • Two adjustable wrenches • Two 5 gallon (19 liters) metal pails • Compatible cleaning fluids <div style="display: flex; justify-content: space-around;"> <div style="text-align: center;"> Oil Base </div> <div style="text-align: center;"> Latex </div> </div> <p>Clothing:</p> <ul style="list-style-type: none"> • Respirator • Safety glasses <p>Power: grounded outlet</p> <p>Japan: 100V, 15A United Kingdom: 110V, 15A North/Latin Am: 120V, 15A Europe/South Am: 230V, 10A Australia/Asia: 240V, 10A</p> <ul style="list-style-type: none"> • 12 AWG, (1.5 mm²) grounded extension cord up to 300 feet (100 M) 	<p>LIRE TOUTES LES INSTRUCTIONS ET MISES EN GARDE AVANT D'INSTALLER CET APPAREIL OU DE LE METTRE EN MARCHÉ.</p> <p>Il vous faut:</p> <ul style="list-style-type: none"> • Deux clés à molette • Deux seaux métalliques de 19 l. • Des produits liquides de nettoyage compatibles <div style="display: flex; justify-content: space-around;"> <div style="text-align: center;"> Base huileuse </div> <div style="text-align: center;"> Latex </div> </div> <p>Vêtements:</p> <ul style="list-style-type: none"> • Respirateur • Lunettes de sécurité <p>Alimentation électrique: sortie mise à la terre</p> <p>Japon: 100V, 15A Royaume Uni: 110V, 15A Am. du Nord/latine: 120V, 15A Europe/Am. du Sud: 230V, 10A Australie/Asie: 240V, 10A</p> <ul style="list-style-type: none"> • Prolongateur mis à la terre de 12 AWG, (1,5 mm²) jusqu'à 300 pieds (100 m)
INSTRUÇÕES	INSTRUCCIONES
<p>LEIA TODAS AS INSTRUÇÕES E ADVERTÊNCIAS ANTES DE MONTAR OU UTILIZAR ESTA UNIDADE.</p> <p>Você precisa de:</p> <ul style="list-style-type: none"> • Duas chaves inglesas • Dois baldes metálicos de 19 litros • Líquidos de limpeza compatíveis <div style="display: flex; justify-content: space-around;"> <div style="text-align: center;"> À base de óleo </div> <div style="text-align: center;"> Látex </div> </div> <p>Vestuário:</p> <ul style="list-style-type: none"> • Máscara de respiração • Óculos protectores <p>Alimentação: tomada ligada a terra</p> <p>Japão: 100V, 15A Reino Unido: 110V, 15A Am. do Norte/Latina: 120V, 15A Europa/Am. do Sul: 230V, 10A Austrália/Ásia: 240V, 10A</p> <ul style="list-style-type: none"> • Fio de extensão 12 AWG, (1,5 mm²) com ligação terra até 100 M. 	<p>LEA TODAS LAS INSTRUCCIONES Y ADVERTENCIAS ANTES DE PONER EN MARCHA O DE HACER FUNCIONAR ESTA UNIDAD.</p> <p>Necesitará:</p> <ul style="list-style-type: none"> • Dos llaves inglesas • Dos cubos de metal de 19 litros • Fluidos de limpieza compatibles <div style="display: flex; justify-content: space-around;"> <div style="text-align: center;"> Base de aceite </div> <div style="text-align: center;"> Látex </div> </div> <p>Ropas:</p> <ul style="list-style-type: none"> • Respirador • Gafas de seguridad <p>Potencia: toma eléctrica conectada a tierra</p> <p>Japón: 100V, 15A Reino Unido: 110V, 15A Norteam./Am. Latina: 120V, 15A Europa/Sudam.: 230V, 10A Australia/Asia: 240V, 10A</p> <ul style="list-style-type: none"> • 12 AWG, (1.5 mm²) cable de extensión de hasta 100 m (300 pies) conectado a tierra

Specifications

This equipment is not intended for use with flammable or combustible materials used in places such as cabinet shops or other “factory” or fixed locations. If you intend to use this equipment in this type of application, you must comply with NFPA 33 and OSHA requirements for the use of flammable and combustible materials.

The following are general Warnings related to the safe setup, use, maintenance and repair of this equipment. Additional, more specific warnings may be found throughout the text of this manual where applicable.

WARNING



FIRE AND EXPLOSION HAZARD

Flammable fumes, such as solvent and paint fumes, in work area can ignite or explode. To help prevent fire and explosion:





- Use equipment only in well ventilated area.
- Eliminate all ignition sources; such as pilot lights, cigarettes, portable electric lamps, and plastic drop clothes (potential static arc).
- Sprayer generates sparks. When flammable liquid is used in or near sprayer or for flushing or cleaning, keep sprayer at least 20 ft (6 m) away from explosive vapors.
- Do not clean with materials having flash points lower than 70°F (21°C). Use water-based materials or mineral spirits type material only. For complete information about your fluid, request the MSDS from the fluid distributor or retailer.
- Keep work area free of debris, including solvent, rags and gasoline.
- Do not plug or unplug power cords or turn lights on or off when flammable fumes are present.
- Ground equipment and conductive objects in work area. Read Grounding instructions.
- If there is static sparking or you feel a shock, stop operating immediately. Do not use equipment until you identify and correct the problem.



ELECTRIC SHOCK HAZARD

Improper grounding, setup, or usage of the system can cause electric shock.

- Turn off and disconnect power cord before servicing equipment.
- Use only grounded electrical outlets
- Use only 3-wire extension cords.
- Ensure ground prongs are intact on sprayer and extension cords.

	<p>INJECTION HAZARD</p> <p>High pressure fluid from gun, hose leaks, or ruptured components will pierce skin. This may look like just a cut, but it is a serious injury that can result in amputation. Get immediate medical attention.</p> <ul style="list-style-type: none"> • Do not point gun at anyone or any part of the body. • Do not put your hand over the spray tip. • Do not stop or deflect leaks with your hand, body, glove, or rag. • Engage trigger lock when not spraying. • Follow Pressure Relief Procedure in this manual, when you stop spraying and before cleaning, checking or servicing equipment.
 <p>INSTRUCTIONS</p>	<p>EQUIPMENT MISUSE HAZARD</p> <p>Misuse can cause death or serious injury.</p> <ul style="list-style-type: none"> • Do not exceed the maximum working pressure or temperature rating of the lowest rated system component. Read Technical Data in all equipment manuals. • Use fluids and solvents that are compatible with equipment wetted parts. Read Technical Data in all equipment manuals. Read fluid and solvent manufacturer's warnings. • Check equipment daily. Repair or replace worn or damaged parts immediately. • Do not alter or modify equipment. • Use equipment only for its intended purpose. Call your Graco distributor for information. • Route hoses and cables away from traffic areas, sharp edges, moving parts and hot surfaces. • Do not use hoses to pull equipment. • Keep children and animals away from work area. • Comply with all applicable safety regulations.
	<p>PRESSURIZED ALUMINUM PARTS HAZARD</p> <p>Do not use 1,1,1-trichloroethane, methylene chloride, other halogenated hydrocarbon solvents or fluids containing such solvents in this equipment. Such use could result in a serious chemical reaction, with the possibility of explosion, which could cause death, serious injury and/or substantial property damage.</p>
	<p>TOXIC FLUID HAZARD</p> <p>Toxic fluid or fumes can cause serious injury or death if splashed in the eyes or on skin, inhaled, or swallowed.</p> <ul style="list-style-type: none"> • Read MSDS's to know the specific hazards of the fluids you are using. • Store hazardous fluid in approved containers and dispose of it according to all applicable guidelines.
	<p>PERSONAL PROTECTIVE EQUIPMENT</p> <p>You must wear appropriate protective equipment when operating, servicing, or when in the operating area of the equipment to help protect you from serious injury, including eye injury, inhalation of toxic fumes, burns, and hearing loss. This equipment includes, but is not limited to:</p> <ul style="list-style-type: none"> • Protective eye wear. • Clothing and respirator as recommended by the fluid and solvent manufacturer. • Gloves. • Hearing protection.

CARACTÉRISTIQUES

Cet équipement n'est pas prévu pour l'usage avec les matières inflammables ou combustibles employés dans les endroits tels que les magasins de coffret ou tout autre "factory" ; ou endroits fixes. Si vous avez l'intention d'utiliser cet équipement dans ce type d'application, vous devez vous conformer aux conditions de NFPA 33 et d'OSHA pour l'usage des matériaux inflammables et combustibles.

Ce qui suit sont des avertissements généraux liés à l'installation, à l'utilisation, à l'entretien et à la réparation sûrs de cet équipement. Des avertissements additionnels et plus spécifiques peuvent être trouvés dans tout le texte de ce manuel là où applicables.

MISE EN GARDE



RISQUES D'INCENDIE ET D'EXPLOSION

Les vapeurs inflammables de solvant et de peinture sur le lieu de travail peuvent prendre feu ou exploser. Pour prévenir un incendie ou une explosion :







- Utiliser l'appareil uniquement dans un local bien aéré. Ne pas faire le plein de carburant pendant que le moteur tourne ou qu'il est chaud; arrêter le moteur et le laisser refroidir. Le carburant peut s'enflammer ou exploser au contact d'une surface brûlante.
- Si l'on pulvérise un liquide inflammable ou qu'on l'utilise pour rincer ou nettoyer, maintenir le pulvérisateur à 20 pieds (6 m) minimum des vapeurs explosives.
- Supprimer toutes les sources de feu, telles que les veilleuses, cigarettes, lampes de poche et bâches plastique (risque d'électricité statique).
- Veiller à débarrasser la zone de travail de tout résidu, comme les solvants, les chiffons et l'essence.
- Ne pas brancher ni débrancher de cordons d'alimentation électrique ni actionner de commutateur marche-arrêt ou de lumière en présence de vapeurs inflammables.
- Raccorder à la terre le matériel et les objets conducteurs du site. Voir les instructions de Mise à la terre.
- N'utiliser que des flexibles mis à la terre.
- Tenir le pistolet fermement contre la paroi d'un seau mis à la terre lorsqu'on pulvérise dans le seau.
- Si l'on constate la moindre étincelle d'électricité statique ou si l'on ressent une décharge électrique, arrêter le travail immédiatement. Ne pas utiliser le matériel tant que le problème n'a pas été identifié et résolu.



DANGER DE DÉCHARGE ÉLECTRIQUE

Une mauvaise mise à la terre, installation ou utilisation de l'appareil risque de provoquer une décharge électrique.

- Couper le courant et débrancher le cordon d'alimentation avant d'entreprendre un entretien quelconque.
- N'utiliser que des prises électriques reliées à la terre.
- N'utiliser que des rallonges à 3 conducteurs.
- S'assurer que les fiches de terre du pulvérisateur et des rallonges sont intactes.

	<p>DANGER D'INJECTION</p> <p>Le produit s'échappant à haute pression du pistolet, d'une fuite sur le flexible ou d'un composant défectueux risque de transpercer la peau. La blessure peut avoir l'aspect d'une simple coupure, mais il s'agit en fait d'une blessure sérieuse pouvant entraîner une amputation. Consulter immédiatement un médecin.</p> <ul style="list-style-type: none"> • Ne pas diriger le pistolet sur quelqu'un ou une partie quelconque du corps. • Ne pas mettre la main devant la buse de pulvérisation. • Ne jamais colmater ou dévier les fuites avec la main, le corps, un gant ou un chiffon. • Ne pas pulvériser sans garde-buse ni sous-garde. • Verrouiller la gâchette à chaque arrêt de la pulvérisation. • Suivre la Procédure de décompression de ce manuel à chaque interruption de la pulvérisation et avant le nettoyage, la vérification ou l'entretien du matériel.
 <p>INSTRUCTIONS</p>	<p>DANGER EN CAS DE MAUVAISE UTILISATION DE L'ÉQUIPEMENT</p> <p>Toute mauvaise utilisation du matériel peut provoquer des blessures graves, voire mortelles.</p> <ul style="list-style-type: none"> • Ne pas dépasser la pression ou température de service maximum spécifiée de l'élément le plus faible du système. Voir les Caractéristiques techniques de tous les manuels de l'appareil. • Utiliser des produits et solvants compatibles avec les pièces en contact avec le produit. Voir les Caractéristiques techniques de tous les manuels d'équipement. Lire les mises en garde du fabricant de produit et de solvant. • Vérifier l'équipement tous les jours. Réparer ou remplacer immédiatement les pièces usagées ou endommagées. • Ne pas modifier cet équipement. • N'utiliser ce matériel que pour l'usage auquel il est destiné. Pour plus de renseignements appelez votre distributeur Graco. • Écarter les flexibles et câbles électriques des zones de circulation, des bords coupants, des pièces en mouvement et des surfaces chaudes. • Ne jamais utiliser de flexibles pour tirer le matériel. • Tenir les enfants et animaux à l'écart du site de travail. • Se conformer à toutes les règles de sécurité applicables.
	<p>RISQUES DUS AUX PIÈCES EN ALUMINIUM SOUS PRESSION</p> <p>N'utiliser ni 1,1,1-trichloréthane, ni chlorure de méthylène, ni solvants à base d'hydrocarbures halogénés, ni produits contenant de tels solvants dans un appareil sous pression en aluminium. L'utilisation de ces produits risque de déclencher une violente réaction chimique avec casse du matériel et provoquer ainsi de graves dommages corporels et matériels pouvant entraîner la mort.</p>
	<p>DANGERS PRESENTES PAR LES PRODUITS OU VAPEURS TOXIQUES</p> <p>Les produits ou vapeurs toxiques peuvent causer de graves blessures et entraîner la mort en cas de projection dans les yeux ou sur la peau, en cas d'inhalation ou d'ingestion.</p> <ul style="list-style-type: none"> • Lire la fiche de sécurité produit (MSDS) pour prendre connaissance des risques spécifiques aux produits utilisés. • Stocker les produits dangereux dans des récipients homologués et les éliminer conformément à la réglementation en vigueur.
	<p>ÉQUIPEMENT DE PROTECTION DU PERSONNEL</p> <p>Il est impératif que le personnel porte un équipement de protection approprié quand il travaille ou se trouve dans la zone de fonctionnement de l'installation pour éviter des blessures graves telles que des lésions oculaires, inhalation de fumées toxiques, brûlures et perte de l'ouïe notamment. Cet équipement comprend ce qui suit, la liste n°2</p> <ul style="list-style-type: none"> • Lunettes de sécurité • Le port de vêtements de sécurité et d'un respirateur est conseillé par le fabricant de produit et de solvant • Gants • Casque anti-bruit

ESPECIFICAÇÕES

Este equipamento não é pretendido para o uso com os materiais inflamáveis ou combustíveis usados nos lugares tais como lojas do armário ou o outro “factory” ou posições fixas. Se você pretender usar este equipamento neste tipo de aplicação, você deve comply com as exigências de NFPA 33 e de OSHA para o uso de materiais inflamáveis e combustíveis.

Os seguintes são avisos gerais relacionados à instalação, ao uso, à manutenção e ao reparo seguros deste equipamento. Os avisos adicionais, mais específicos podem ser encontrados durante todo o texto deste manual onde aplicáveis.

ADVERTÊNCIA



PERIGO DE INCÊNDIO E EXPLOSÃO

Os vapores inflamáveis na área de trabalho, tais como os provenientes de solventes e tintas, podem inflamar-se ou explodir. Para ajudar a evitar incêndios e explosões:

- Utilize o equipamento apenas em áreas bem ventiladas.
- Elimine todas as fontes de ignição, como, por exemplo, luzes piloto, cigarros, luzes eléctricas portáteis e plásticos de protecção (potencial arco estático).
- Mantenha a área de trabalho sem detritos, incluindo solvente, panos e gasolina.
- Não ligue nem desligue cabos de alimentação ou luzes na presença de vapores inflamáveis.
- Ligue o equipamento e os objectos condutores presentes na área de trabalho à terra. Consulte as instruções de Ligação à terra, 309941.
- O pulverizador gera faíscas. Quando o líquido inflamável é usado dentro ou pulverizador próximo ou nivelando ou limpando, mantenha o pulverizador ao menos 20 pés (6 m) ausentes dos vapores explosivos.
- Não limpe com os materiais que têm pontos flash mais baixo do que 70°F (21°C) water-based ou o tipo mineral material dos espíritos somente. Para a informação completa sobre seu líquido, peça MSDS do distribuidor fluido ou do varejista.
- Se ocorrerem faíscas de estática ou se sentir um choque eléctrico, interrompa a utilização imediatamente. Não utilize o equipamento até identificar e eliminar o problema.



PERIGO DE CHOQUE ELÉCTRICO

Se os procedimentos de ligação à terra, instalação ou utilização do sistema não forem os adequados, poderão ocorrer choques eléctricos.

- Desligue o cabo de alimentação antes de efectuar procedimentos de manutenção no equipamento.
- Utilize unicamente tomadas eléctricas ligadas à terra.
- Utilize unicamente extensões trifilares.
- Certifique-se de que os pinos de ligação à terra estão intactos no equipamento e nos fios de extensão.







PERIGO DE INJEÇÃO

O produto a alta pressão proveniente da pistola, fugas nos tubos flexíveis ou componentes danificados poderá provocar lesões na pele. As lesões podem ter o aspecto de um simples corte, porém, constituem ferimentos graves capazes de conduzir à amputação. Obtenha aconselhamento médico imediato.



- Não aponte a pistola a ninguém nem a nenhuma parte do corpo.
- Não coloque as mãos sobre o bico.
- Não tente interromper ou desviar fugas com a mão, o corpo, uma luva ou um pano.
- Engate o dispositivo de segurança do gatilho quando não estiver a pintar.
- Siga o **Procedimento de Descompressão** neste manual, quando parar de pintar e antes de dar início aos procedimentos de limpeza, verificação ou manutenção.

 <p>INSTRUCTIONS</p>	<p>PERIGO DO EMPREGO ERRADO DO EQUIPAMENTO</p> <p>O emprego errado pode causar a morte ou ferimento sério.</p> <ul style="list-style-type: none"> • Não exceda a avaliação máxima do working pressure ou da temperatura do componente rated o mais baixo do sistema. Leia dados técnicos em todos os manuais do equipamento. • Use os líquidos e os solventes que são compatíveis com as peças molhadas equipamento. Leia dados técnicos em todos os manuais do equipamento. Leia os avisos fluidos e solvent de manufacturer's. • Use os líquidos e os solventes que são compatíveis com as peças molhadas equipamento. Leia dados técnicos em todos os manuais do equipamento. Leia os avisos fluidos e solvent de manufacturer's. • Não altere nem não modifique o equipamento. • Use o equipment somente para sua finalidade pretendida. Chame seu distribuidor de Graco para a informação. • Distribua mangueiras e cabos away das áreas de tráfego, das bordas afiadas, das peças moventes e das superfícies quentes. • Não use mangueiras puxar o equipamento. • Mantenha as crianças e os animais ausentes da área de trabalho. • Comply com todos os regulamentos aplicáveis de segurança.
	<p>PERIGO DE PEÇAS DE ALUMÍNIO PRESSURIZADO</p> <p>Não utilize 1,1,1-tricloroetano, cloreto de metileno, outros solventes de hidrocarboneto halogenado ou produtos que contenham os solventes referidos em equipamento de alumínio pressurizado. A utilização dos produtos referidos pode provocar reações químicas violentas e avaria do equipamento e resultar em morte, lesões graves e danos em bens.</p>
	<p>PERIGO FLUIDO TÓXICO</p> <p>O líquido ou as emissões tóxicas podem causar ferimento ou a morte séria se espirrado nos olhos ou na pele, inhaled, ou engolido.</p> <ul style="list-style-type: none"> • Leia MSDS's para saber os perigos específicos dos líquidos que você se está usando. • Armazene o líquido perigoso em uns recipientes aprovados e disponha d que accordiing a todos os guidelines aplicáveis.
	<p>EQUIPAMENTO DE PROTECÇÃO PESSOAL</p> <p>Deve usar equipamento de protecção adequado quando utilizar e efectuar procedimentos de manutenção no equipamento, ou quando se encontrar na área de funcionamento do mesmo. O equipamento de protecção protege-o de lesões graves, tais como lesões oculares, inalação de vapores tóxicos, queimaduras e perda de audição. O equipamento protector inclui o seguinte, apesar de não se limitar a tal:</p> <ul style="list-style-type: none"> • Protecção para os olhos • Vestuário protector e máscara, como recomendado pelo fabricante do produto e solvente • Luvas • Protecção para os ouvidos

ESPECIFICACIONES

Este equipo no se piensa para el uso con los materiales inflamables o combustibles usados en lugares tales como tiendas del gabinete u otro “factory” o localizaciones fijas. Si usted se prepone utilizar este equipo en este tipo de uso, usted debe conformarse con los requisitos de NFPA 33 y del OSHA para el uso de materiales inflamables y combustibles.

Los siguientes son advertencias generales relacionadas con la disposición, el uso, el mantenimiento y la reparación seguros de este equipo. Las advertencias adicionales, más específicas se pueden encontrar a través del texto de este manual donde aplicables.

ADVERTENCIA



PELIGRO DE INCENDIOS Y EXPLOSIONES

Los vapores inflamables, como los vapores de disolvente o de pintura, en la zona de trabajo pueden incendiarse o explotar. Para evitar un incendio o explosión:



- Utilice el equipo únicamente en áreas bien ventiladas. No llene el depósito de combustible mientras el motor esté en marcha o caliente; apague el motor y espere a que enfríe. El combustible es inflamable y puede incendiarse o explotar si se derrama sobre una superficie caliente.
- Cuando los líquidos inflamables se pulverizan o se utilizan para lavar el equipo, mantenga el pulverizador a una distancia mínima de 6 m (20 pies) de los vapores explosivos.
- Elimine toda fuente de ignición, tales como las luces piloto, los cigarrillos, lámparas eléctricas portátiles y las cubiertas de plástico (arcos estáticos potenciales).
- Mantenga limpia la zona de trabajo, sin disolventes, trapos o gasolina.
- No enchufe ni desenchufe cables de alimentación ni apague ni encienda las luces en el área de pulverización.
- Conecte a tierra el equipo y los objetos conductores de la zona de trabajo. Vea las instrucciones de Conexión a tierra.
- Utilice únicamente mangueras conectadas a tierra.
- Sujete firmemente la pistola contra el lateral de una lata conectada a tierra mientras dispara la pistola hacia el interior de la misma.
- Si se aprecia la formación de electricidad estática durante el uso de este equipo, deje de trabajar inmediatamente. No utilice el sistema hasta haber identificado y corregido el problema.



PELIGRO DE DESCARGA ELÉCTRICA

Una conexión a tierra o cableado incorrecto puede causar descargas eléctricas.

- Apague y desconecte el cable de alimentación eléctrica en el interruptor de corriente antes de desconectar los cables y revisar el equipo.
- Utilice únicamente tomas eléctricas conectadas a tierra.
- Utilice únicamente cables de extensión de 3 hilos.
- Compruebe que los terminales de conexión a tierra del pulverizador y de los cables de extensión están intactas.

	<p>PELIGRO DE INYECCIÓN</p> <p>El fluido a alta presión procedente de la pistola, fugas de la manguera o componentes rotos penetrarán en la piel. La inyección del líquido puede tener la apariencia de un simple corte, pero se trata de una herida grave que puede conducir a la amputación. Consiga atención médica inmediatamente.</p> <ul style="list-style-type: none"> • No apunte nunca la pistola hacia alguien o alguna parte del cuerpo. • No coloque la mano sobre la boquilla de pulverización. • No intente bloquear ni desviar posibles fugas con la mano, el cuerpo, los guantes o con un trapo. • No pulverice sin la protección de la boquilla y el seguro del gatillo. • Enganche el seguro del gatillo cuando no esté pulverizando. • Siga el Procedimiento de descompresión de este manual, cuando deje de pulverizar y antes de limpiar, revisar o reparar el equipo.
 <p>INSTRUCTIONS</p>	<p>PELIGROS DEBIDOS A LA UTILIZACIÓN INCORRECTA DEL EQUIPO</p> <p>El uso incorrecto puede causar la muerte o heridas graves.</p> <ul style="list-style-type: none"> • No exceda la presión máxima de trabajo o la temperatura del componente con menor valor nominal del sistema. Consulte la sección Características técnicas de todos los manuales del equipo. • Utilice líquidos y disolventes compatibles con las piezas húmedas del equipo. Consulte las Características técnicas en todos los manuales que acompañan al equipo. Lea las recomendaciones de los fabricantes de los líquidos. • Revise el equipo a diario. Repare o cambie inmediatamente las piezas desgastadas o dañadas. • No altere ni modifique el equipo. • Utilice el equipo únicamente para el fin para el que ha sido destinado. Si desea información, póngase en contacto con su distribuidor Graco. • Desvíe las mangueras de zonas de tráfico intenso, de curvas pronunciadas, de piezas móviles y superficies calientes. • No utilice las mangueras para tirar del equipo. • Mantenga a los niños y a los animales lejos de la zona de trabajo. • Respete todas las normas relativas a la seguridad.
	<p>PELIGRO DE PIEZAS DE ALUMINIO A PRESIÓN</p> <p>No utilice 1,1,1 tricloroetano, cloruro de metileno y otros disolventes de hidrocarburos halogenados o productos que contengan dichos disolventes con equipos de aluminio presurizados. Esas sustancias podrían provocar peligrosas reacciones químicas y ruptura del equipo, y causar la muerte, lesiones graves y daños materiales.</p>
	<p>PELIGRO DE VAPORES O LÍQUIDOS TÓXICOS</p> <p>Los líquidos o los vapores tóxicos pueden provocar serios daños o incluso la muerte si entran en contacto con los ojos o la piel, se inhalan o se ingieren.</p> <ul style="list-style-type: none"> • Lea la Hoja de datos de seguridad del material (MSDS) para conocer los peligros específicos de los líquidos que esté utilizando. • Guarde los fluidos peligrosos en un envase adecuado que haya sido aprobado. Proceda a su evacuación siguiendo las directrices pertinentes.
	<p>EQUIPO DE PROTECCIÓN PERSONAL</p> <p>Debe utilizar equipo de protección adecuado cuando trabaje, revise o esté en la zona de funcionamiento del equipo, con el fin de protegerse contra la posibilidad de lesionarse gravemente, incluyendo lesiones oculares, la inhalación de vapores tóxicos, quemaduras o la pérdida auditiva. Este equipo incluye, pero no está limitado a:</p> <ul style="list-style-type: none"> • Gafas de protección • Ropas protectoras y un respirador, tal como recomiendan los fabricantes del fluido y del disolvente • Guantes • Protección auditiva

CONTROLS / COMMANDES / CONTROLOS / CONTROLES

On/Off Switch / Interrupteur
 Marche/Arrêt / Interruptor de ligar e
 desligar / Interruptor On/Off

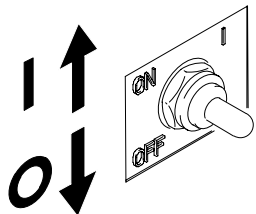

Trigger Lock / Verrouillage gâchette
 Fecho do gatilho / Seguro del gatillo

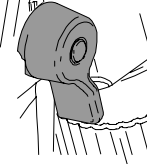
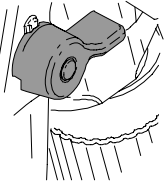

Pressure Gauge / Manomètre
 Manómetro / Manómetro

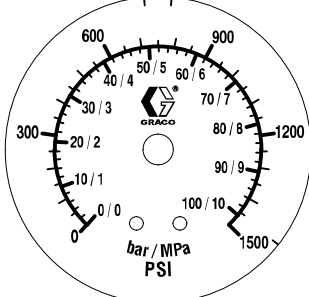

Not available on all models / Non disponible
 sur tous les modèles / Não disponível em
 todos os modelos / No está disponible en
 todos los modelos

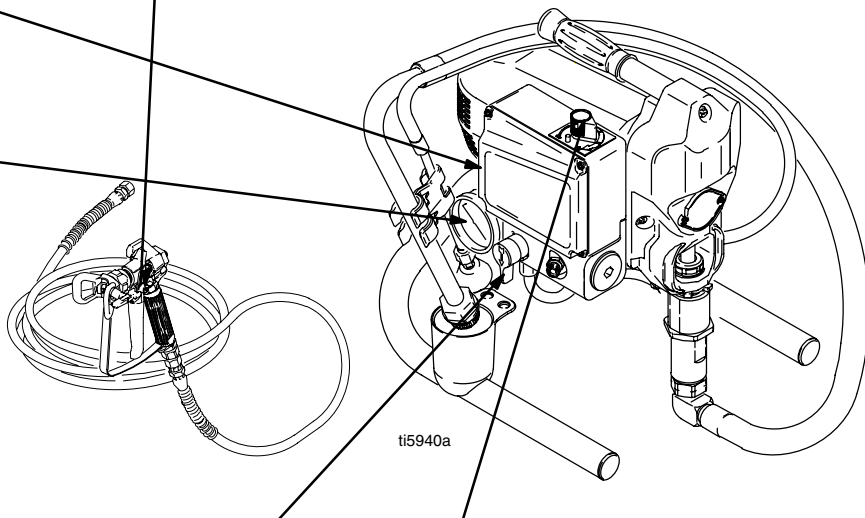

Drain Valve / Vanne de décharge
 Válvula de retorno / Válvula de drenaje

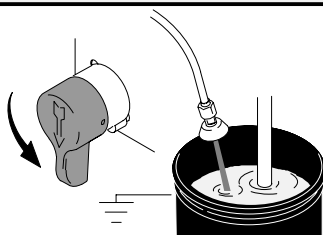
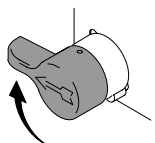

Pressure Control / Régulation de pression
 Regulador da pressão / Control de presión

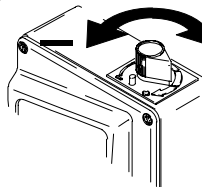

PRESSURE RELIEF / DÉCOMPRESSION DESCOMPRESSÃO / DESCOMPRESIÓN



Follow 1-5 when you
 stop spraying.
 Effectuer les opérations
 1-5 lors d'un arrêt de la
 pulvérisation.

Siga os passos de 1-5 quando parar
 de pintar.
 Cuando deje de pulverizar, siga los
 pasos 1-5.

1

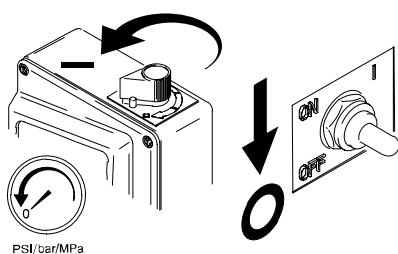

2

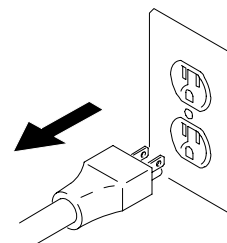

3

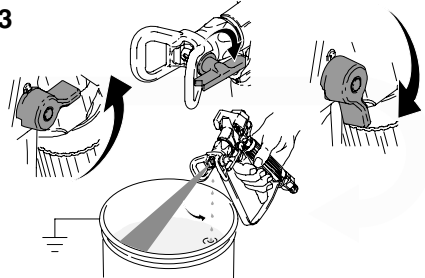

4

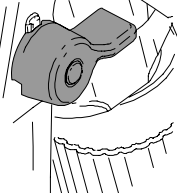

5

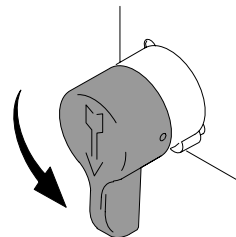

STARTUP / DEMARRAGE / ARRANQUE / PUESTA EN MARCHA

	<p>1</p> <p>WARNING ADVERTENCIA</p> <p>MISE EN GARDE ADVERTENCIA</p>	<p>2</p>	<p>3</p>
--	---	-----------------	-----------------

Flush / Rinçage / Lavagem / Lavado 4→11

<p>4</p> <p>WARNING ADVERTENCIA</p> <p>MISE EN GARDE ADVERTENCIA</p>	<p>5</p>	<p>6</p> <p>+ 1/2</p> <p>10 SEC</p>	<p>7</p>
<p>8</p> <p>3 MIN</p>	<p>9</p> <p>1 MIN</p>	<p>10</p> <p>10 SEC</p>	<p>11</p>

Prime / Amorçage / Ferrar / Cebado 12→15

<p>12</p> <p>WARNING ADVERTENCIA</p> <p>MISE EN GARDE ADVERTENCIA</p>	<p>13</p> <p>Watch for paint. Attention à la peinture. Cuidado com a tinta. Observe la aparición de pintura.</p>	<p>14</p>	<p>15</p> <p>Watch for paint. Attention à la peinture. Cuidado com a tinta. Observe la aparición de pintura.</p>
--	---	------------------	---

SPRAY / PULVÉRISATION / PINTURA / PULVERIZACIÓN

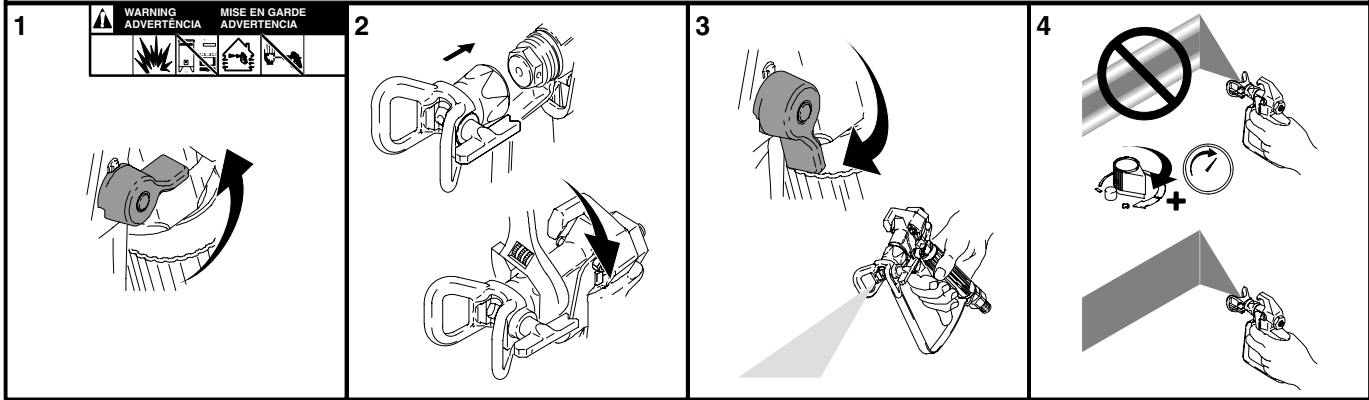



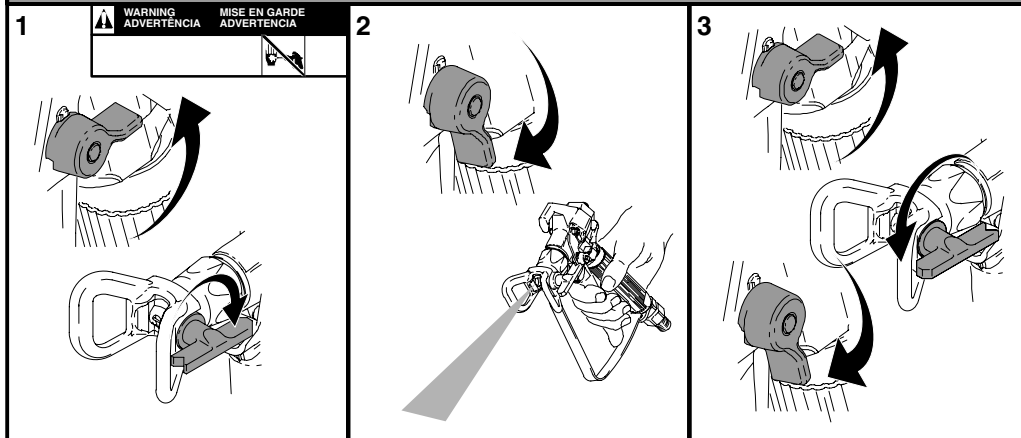



CLEAR CLOG / DÉBOUCHER LA BUSE ELIMINAR A OBSTRUÇÃO / ELIMINAR OBSTRUCCIÓN

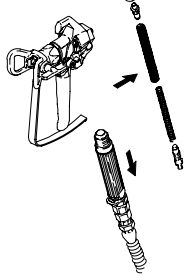
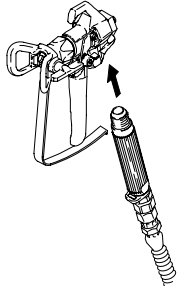
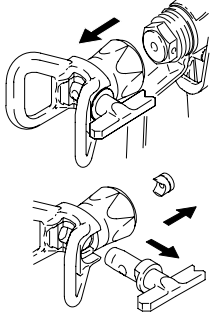
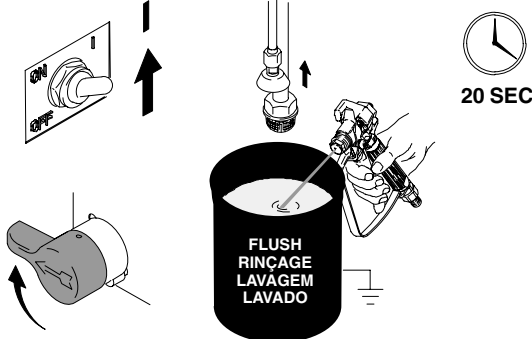

CHANGE PAINT / CHANGER LA PEINTURE TROCA DE TINTA / CAMBIAR DE PINTURA

<p>1</p> <p>MPa/bar/PSI</p> <p>Pressure Relief Décompression Alívio de pressão Descompresión</p>	<p>2</p> <p>Flush</p> <p>Rincer</p> <p>Lavagem</p> <p>Lavado</p>	<p>3</p> <p>Prime</p> <p>Amorçage</p> <p>Ferrar</p> <p>Cebado</p>
--	--	---

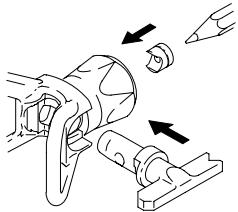
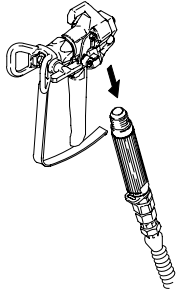
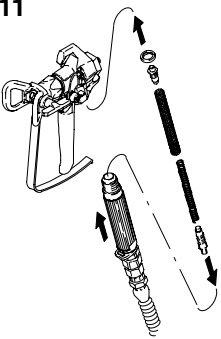
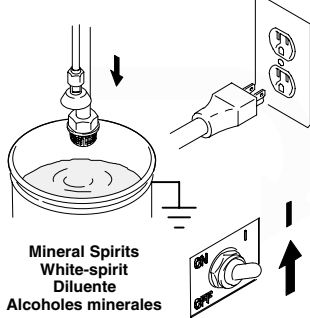
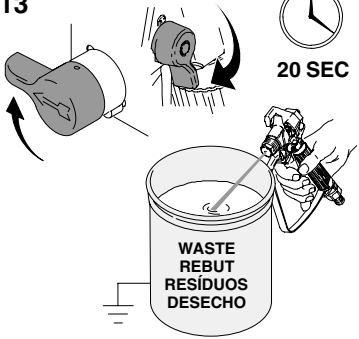
SHUTDOWN / ARRÊT / PARAGEM / PARADA

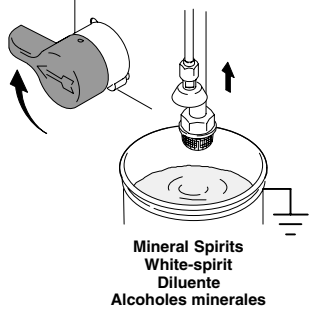
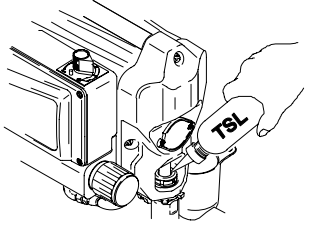
<p>1</p>  <p>Pressure Relief Décompression Alívio de pressão Descompresión</p>	<p>2</p>  	<p>3</p> 	<p>4</p> 	
<p>5</p> <p>Flush Rincer Lavagem Lavado</p>	<p>6</p>  <p>20 SEC</p>	<p>7</p>  <p>Pressure Relief Décompression Alívio de pressão Descompresión</p>		
<p>8</p>  <p>FLUSH RINÇAGE LAVAGEM LAVADO</p>	<p>9</p> 	<p>10</p> 	<p>11</p> 	<p>12</p>  <p>Mineral Spirits White-spirit Diluente Alcoholes minerales</p> <p>20 SEC</p>
<p>13</p>  <p>WASTE REBUT RESÍDUOS DESECHO</p> <p>20 SEC</p>	<p>14</p>  <p>Pressure Relief Décompression Alívio de pressão Descompresión</p>	<p>15</p>  <p>Mineral Spirits White-spirit Diluente Alcoholes minerales</p>	<p>16</p>  <p>TSL</p>	

GROUNDING / MISE À LA TERRE LIGAÇÃO A TERRA / CONEXIÓN A TIERRA

1  **WARNING
ADVERTENCIA** **MISE EN GARDE
ADVERTENCIA**

Grounded Outlets Required
Sorties mises à la terre
obligatoires
Necessárias tomadas com
ligação a terra
Se requieren eléctricas
conectadas a tierra

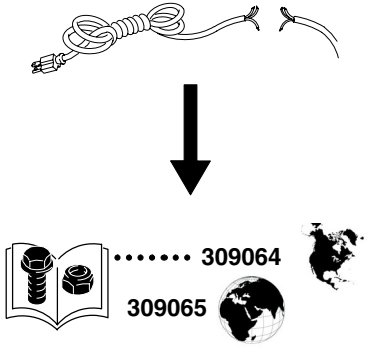
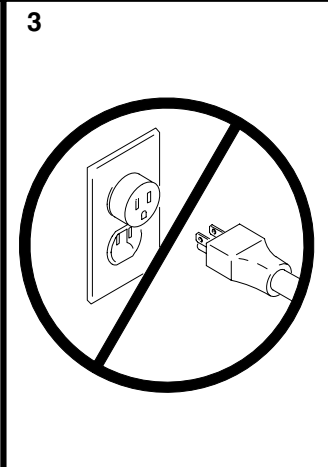

..... **309064**

309065 

Noise / Bruit / Ruído / Ruido

Power / Puissance / Potência / Potencia 87 dB(A)*

Pressure / Pression / Pressão / Presión 75 dB(A)*

* ISO 3744

Graco Standard Warranty

Garantie Graco standard

Garantia Standard da Graco

Garantía estándar de Graco

Graco warrants all equipment referenced in this document which is manufactured by Graco and bearing its name to be free from defects in material and workmanship on the date of sale by an authorized Graco distributor to the original purchaser for use. With the exception of any special, extended, or limited warranty published by Graco, Graco will, for a period of twelve months from the date of sale, repair or replace any part of the equipment determined by Graco to be defective. This warranty applies only when the equipment is installed, operated and maintained in accordance with Graco's written recommendations.

This warranty does not cover, and Graco shall not be liable for general wear and tear, or any malfunction, damage or wear caused by faulty installation, misapplication, abrasion, corrosion, inadequate or improper maintenance, negligence, accident, tampering, or substitution of non-Graco component parts. Nor shall Graco be liable for malfunction, damage or wear caused by the incompatibility of Graco equipment with structures, accessories, equipment or materials not supplied by Graco, or the improper design, manufacture, installation, operation or maintenance of structures, accessories, equipment or materials not supplied by Graco.

This warranty is conditioned upon the prepaid return of the equipment claimed to be defective to an authorized Graco distributor for verification of the claimed defect. If the claimed defect is verified, Graco will repair or replace free of charge any defective parts. The equipment will be returned to the original purchaser transportation prepaid. If inspection of the equipment does not disclose any defect in material or workmanship, repairs will be made at a reasonable charge, which charges may include the costs of parts, labor, and transportation.

THIS WARRANTY IS EXCLUSIVE, AND IS IN LIEU OF ANY OTHER WARRANTIES, EXPRESS OR IMPLIED, INCLUDING BUT NOT LIMITED TO WARRANTY OF MERCHANTABILITY OR WARRANTY OF FITNESS FOR A PARTICULAR PURPOSE.

Graco's sole obligation and buyer's sole remedy for any breach of warranty shall be as set forth above. The buyer agrees that no other remedy (including, but not limited to, incidental or consequential damages for lost profits, lost sales, injury to person or property, or any other incidental or consequential loss) shall be available. Any action for breach of warranty must be brought within two (2) years of the date of sale.

GRACO MAKES NO WARRANTY, AND DISCLAIMS ALL IMPLIED WARRANTIES OF MERCHANTABILITY AND FITNESS FOR A PARTICULAR PURPOSE, IN CONNECTION WITH ACCESSORIES, EQUIPMENT, MATERIALS OR COMPONENTS SOLD BUT NOT MANUFACTURED BY GRACO. These items sold, but not manufactured by Graco (such as electric motors, switches, hose, etc.), are subject to the warranty, if any, of their manufacturer. Graco will provide purchaser with reasonable assistance in making any claim for breach of these warranties.

In no event will Graco be liable for indirect, incidental, special or consequential damages resulting from Graco supplying equipment hereunder, or the furnishing, performance, or use of any products or other goods sold hereto, whether due to a breach of contract, breach of warranty, the negligence of Graco, or otherwise.

FOR GRACO BRAZILIAN/CANADIAN/COLUMBIAN CUSTOMERS

The Parties acknowledge that they have required that the present document, as well as all documents, notices and legal proceedings entered into, given or instituted pursuant hereto or relating directly or indirectly hereto, be drawn up in English.

À L'ATTENTION DES CLIENTS BRÉSILIENS/CANADIENS/COLOMBIENS DE GRACO

Les parties reconnaissent avoir convenu que la rédaction du présente document sera en Anglais, ainsi que tous documents, avis et procédures judiciaires exécutés, donnés ou intentés à la suite de ou en rapport, directement ou indirectement, avec les procédures concernées.

PARA CLIENTES BRASILEIROS/CANADIANOS/COLOMBIANOS DA GRACO

As partes confirmam que solicitaram que o presente documento, assim como todos os demais documentos, notas e processos legais inseridos, atribuídos ou instituídos de acordo com o mesmo ou relacionados directa ou indirectamente com este documento, fossem redigidos em inglês.

PARA LOS CLIENTES EN BRASIL/CANADÁ/COLOMBIA

Las partes reconocen haber convenido que el presente documento, así como todos los documentos, notificaciones y procedimientos judiciales emprendidos, presentados o establecidos que tengan que ver con estas garantías directa o indirectamente, estarán redactados en inglés.

ADDITIONAL WARRANTY COVERAGE / AVENANT DE GARANTIE / COBERTURA DE GARANTIA ADICIONAL / COBERTURA ADICIONAL DE LA GARANTÍA

Graco does provide extended warranty and wear warranty for products described in the "Graco Contractor Equipment Warranty Program".

Graco accorde une garantie étendue et se porte garant des produits décrits dans le "Programme de garantie d'équipements des fournisseurs Graco".

A Graco fornece prorrogação de garantia e garantia de desgaste para os produtos descritos no "Graco Contractor Equipment Warranty Program" (Programa de garantia de equipamento Contractor da Graco).

Graco proporciona una garantía extendida y una garantía que cubre el desgaste de los productos descritos en el "Programa de Garantía del Equipo Contractor de Graco".

POUR PASSER COMMANDE OU DEMANDER UNE PRESTATION D'ENTRETIEN, contactez votre distributeur Graco.

PARA EFECTUAR ENCOMENDAS OU PARA ASSISTÊNCIA TÉCNICA, contacte o seu distribuidor da Graco.

PARA REMITIR UN PEDIDO O SOLICITAR SERVICIO, póngase en contacto con el distribuidor de Graco.

All written and visual data contained in this document reflects the latest product information available at the time of publication. Graco reserves the right to make changes at any time without notice.

Toutes les données écrites et visuelles figurant dans ce document reflètent les toutes dernières informations disponibles au moment de sa publication. Graco se réserve le droit de procéder à des modifications à tout moment sans avis préalable.

Todo o texto e desenhos contidos neste documento reflectem as mais recentes informações sobre o produto disponíveis na altura da publicação.

A Graco reserva-se o direito de efectuar alterações em qualquer momento sem aviso prévio.

Todos los datos, escritos y visuales, contenidos en este documento reflejan la información más reciente sobre el producto disponible en el momento de su publicación, Graco se reserva el derecho de realizar cambios en cualquier momento, sin previo aviso.

Sales Office: Minneapolis

Foreign Offices: Belgium, Korea, Hong Kong, Japan

Bureaux des vente: Minneapolis

Bureaux à l'étranger: Belgique, Corée, Hong-Kong, Japon

Escritórios de Vendas: Minneapolis

Escritórios estrangeiros: Bélgica, Coreia, Hong Kong, Japão

Oficinas de ventas: Minneapolis

Oficinas en el extranjero: Bélgica, Corea, Hong Kong, Japón

GRACO INC. P.O. BOX 1441 MINNEAPOLIS, MN 55440-1441

<http://www.graco.com>

PRINTED IN USA 309059 11/1999, Revised 11/2004

IMPRIMÉ AUX É.-U. 309059 11/1999, Révisé 11/2004

IMPRESO EN EE.UU. 309059 11/1999, Revisado 11/2004

IMPRESSO NOS EUA 309059 11/1999, Revisado 11/2004