

SG3 Airless Spray Guns

Pistolets pulvérisateurs sans air SG3

Pistola de pulverización sin aire SG3

Pistolas de pulverização a alta pressão SG3

3600 psi (248 bar, 24.8 MPa) Maximum Working Pressure

Pression de service maximum 3600 psi (248 bar, 24.8 MPa)

Presión máxima de funcionamiento de 3600 psi (248 bar, 24.8 MPa)

Pressão máxima de trabalho de 3600 psi (248 bar, 24.8 MPa)

SG3

243012, A

Reversible Tip Guard, 515 Tip

Garde-buse réversible, 515 Tip

Protección de boquilla reversible, boquilla 515

Protecção do bico reversível, bico 515

All models not available in all countries

Tous les modèles ne sont pas disponibles dans tous les pays

Hay modelos que no se distribuyen en todos los países

Nem todos os modelos se encontram disponíveis em todos os países

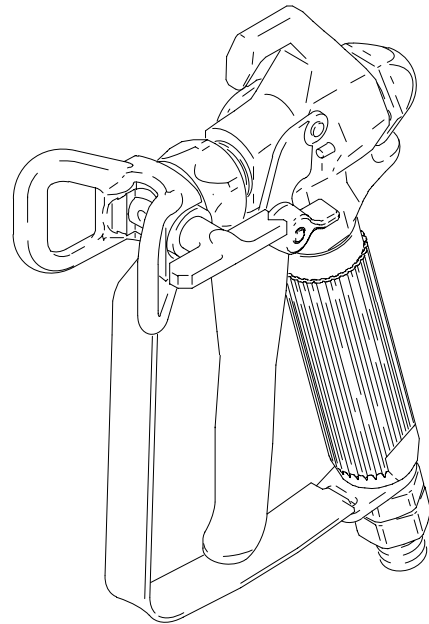

05963

243012

⚠ WARNING

Fire and explosion hazard: Solvent and paint fumes can ignite or explode.

To help prevent a fire and explosion:

- Use in an extremely well ventilated area.
- Eliminate all ignition sources; such as pilot lights, cigarettes and static arcs from plastic drop cloths. Do not plug or unplug power cords or turn lights on or off in spray area.
- Ground Sprayer, object being sprayed, paint and solvent pails.
- Hold gun firmly to side of grounded pail when triggering into pail.
- Use only conductive airless paint hose.
- Do not use 1,1,1-trichloroethane, methylene chloride, other halogenated hydrocarbon solvents or fluids containing such solvents in pressurized aluminum equipment. Such use could result in a chemical reaction, with the possibility of explosion.



⚠ MISE EN GARDE

Risques d'incendie et d'explosion: Les vapeurs de solvant et de peinture peuvent s'enflammer ou causer une explosion.

Pour empêcher tout incendie et explosion:

- N'utiliser ce matériel que dans des locaux extrêmement bien aérés.
- Éliminer toutes les sources de feu, comme les veilleuses, cigarettes et les arcs statiques provenant de bâches plastique. Ne pas brancher ou débrancher de cordon électrique ou allumer ou éteindre la lumière sur un site de pulvérisation.
- Raccorder le pulvérisateur, l'objet à peindre et les seaux de peinture et de solvant à la terre.
- Appuyer le pistolet contre le côté du seau mis à la terre quand on pulvérise dans le seau.
- N'utiliser que des flexibles de peinture conducteurs sans air.
- Ne jamais utiliser de trichloroéthane-1,1,1, de chlorure de méthylène, d'autres solvants à base d'hydrocarbures halogénés ni de fluides contenant de tels solvants dans une unité sous pression en aluminium. Cela pourrait provoquer une réaction chimique avec risque d'explosion.

Fluid injection and high pressure hazard: High pressure spray or leaks can inject fluid into the body.

To help prevent injection, always:

- Engage trigger safety latch when not spraying.
- Keep clear of nozzle and leaks.
- Never spray without a tip guard.
- Do **PRESSURE RELIEF** if you stop spraying or begin servicing sprayer.
- Do not use components rated less than sprayer *Maximum Working Pressure*.
- Never allow children to use this unit.
- Brace yourself; gun may recoil when triggered.

If high pressure fluid pierces your skin, the injury might look like "just a cut". But it is a serious wound! Get immediate medical attention.



Risques d'injection, haute pression danger: Une pulvérisation ou des fuites à haute pression peuvent provoquer une injection de produit dans le corps.

Pour éviter toute injection, toujours:

- Verrouiller la gâchette à chaque arrêt de la pulvérisation.
- Se tenir à l'écart de la buse et des fuites.
- Ne jamais se servir du pistolet pour pulvériser sans une protection de buse.
- Effectuer une **DÉCOMPRESSION** à chaque arrêt de la pulvérisation ou avant tout entretien.
- Ne pas utiliser d'éléments prévus pour une pression inférieure à la *pression de service maximum du pulvérisateur*.
- Ne jamais permettre à des enfants d'utiliser cet appareil.
- Croisillon vous-même; le pistolet peut reculer une fois déclenché.

Si du liquide sous haute pression est injecté sous la peau, la blessure peut avoir l'apparence "d'une simple coupure", mais c'est en fait une blessure sérieuse! Consulter un médecin immédiatement.

⚠ ADVERTÊNCIA

Perigo de incêndio e explosão: os solventes e os vapores da pintura poderão explodir ou incendiar.

Para ajudar a evitar incêndio e explosão:

- Utilize em áreas extremamente bem ventiladas.
- Elimine todas as fontes de ignição, tais como luzes piloto, cigarros e arcos estáticos de plásticos de protecção. Não ligue nem desligue os cabos de alimentação nem as luzes numa área de pulverização.
- Ponha em contacto com a terra o pulverizador, o objecto a ser pulverizado e os baldes de tinta e de solventes.
- Segure a pistola firmemente de encontro ao lado do balde em contacto com a terra, quando estiver a descarregar para dentro do mesmo.
- Utilize apenas tubos flexíveis condutores para pintura a alta pressão.
- Não utilize 1,1,1-tricloroetano, cloreto de metileno, outros solventes de hidrocarbonetos halogenados ou líquidos contendo tais solventes em equipamento de alumínio pressurizado. Tal utilização poderá resultar numa reacção química, com possibilidade de explosão.

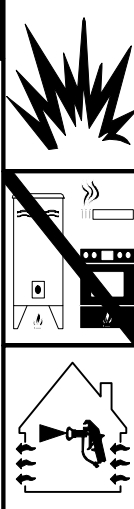

⚠ ADVERTENCIA

Peligro de incendio y explosión: Los vapores de disolvente o de pintura pueden incendiarse o explotar.

Para ayudar a evitar que se produzca un incendio o una explosión:

- Utilizar en una zona extremadamente bien ventilada.
- Elimine toda fuente de ignición; como las luces piloto, los cigarrillos y los arcos estáticos procedentes de cubiertas de plástico. No enchufe ni desenchufe aparatos en las tomas de corrientes de la zona de pulverización.
- Conecte a tierra el pulverizador, el objeto que esté pintando y los cubos de disolvente.
- Sujete firmemente la pistola contra el lado de un recipiente conectado a tierra mientras dispara la pistola hacia el interior del mismo.
- Utilice únicamente mangueras de pintura sin aire, conductoras eléctricamente.
- No utilice nunca 1,1,1-tricloroetano, cloruro de metileno, otros disolventes de hidrocarburo halogenado o fluidos que contengan tales disolventes en una bomba a presión de aluminio. El uso de estas sustancias puede provocar una seria reacción química con riesgos de explosión.

Perigo de injeção de líquidos e de alta pressão: a pulverização ou fugas a alta pressão podem injectar líquido no corpo.

Para ajudar a prevenir a injeção de líquido, faça sempre o seguinte:

- Engate o trinco de segurança do gatilho quando não estiver a pulverizar.
- Mantenha-se afastado de bocais e locais de fuga.
- Nunca pulverize sem protecção no bico.
- **ALIVIE A PRESSÃO** se parar de pulverizar e antes de iniciar a manutenção do pulverizador.
- Não utilize componentes com uma classificação inferior à do pulverizador *Pressão Máxima de Trabalho*.
- Nunca permita que crianças utilizem esta unidade.
- Cinta você mesmo; o pistola pode recoil quando provido.

Se o líquido a alta pressão penetrar na pele, o ferimento poderá parecer "simplesmente um corte". Mas é um ferimento grave! Procure imediatamente assistência médica.



Peligro de inyección de fluido y de alta presión: La pulverización o las fugas a alta presión pueden inyectar fluido en el cuerpo.

Para ayudar a evitar la inyección, siempre:

- Enganche el seguro del gatillo cuando no esté pulverizando.
- Manténgase alejado de la boquilla y de las fugas.
- No pulverice sin una protección en la boquilla.
- Siga el procedimiento de **DESCOMPRESIÓN** si deja de pulverizar o al comenzar la revisión del pulverizador.
- No use componentes cuya presión nominal sea menor que la *Presión máxima de funcionamiento del pulverizador*.
- Nunca permita que los niños utilicen esta unidad.
- Paréntesis usted mismo; la pistola puede retroceso cuando está accionado.

Si el fluido a alta presión penetra la piel, la herida puede parecer "un simple corte". ¡Pero se trata de una herida grave! Consiga inmediatamente atención médica.

CONTROLS / COMMANDES / CONTROLES / CONTROLOS

Trigger Lock / Verrouillage gâchette / Seguro del gatillo / Fecho do gatilho

Needle Adjustment / Réglage du pointeau / Ajuste de la aguja / Regulação da agulha

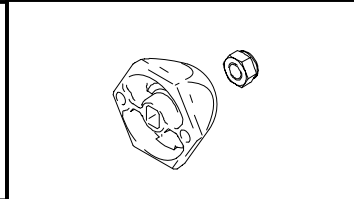
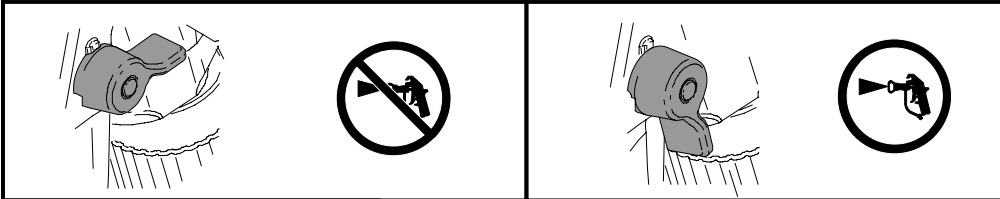

Tip Guard / Garde-buse / Protección de la boquilla / Protecção do bico

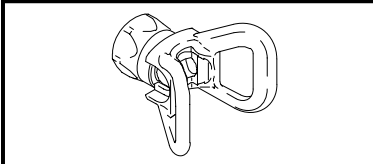

Tip / Buse / Boquilla / Bico

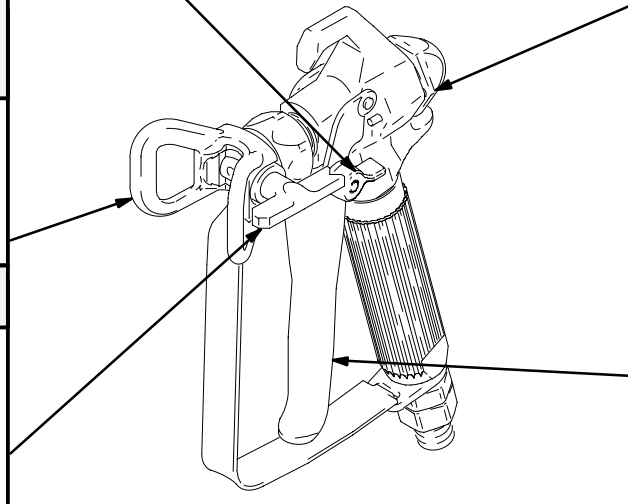
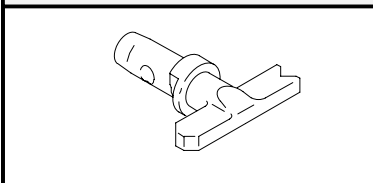

Trigger / Gâchette / Gatillo / Gatilho

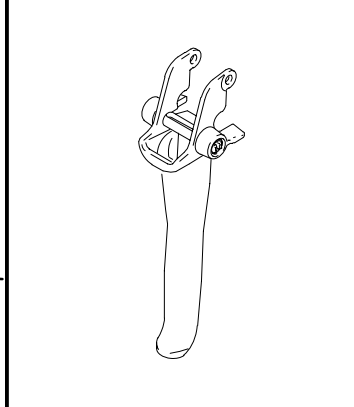

PRESSURE RELIEF / DÉCOMPRESSION / DESCOMPRESIÓN / ALIVIO DE PRESSÃO



Follow 1-5 when you stop spraying.
Effectuer les opérations 1-5 lors d'un arrêt de la pulvérisation.

Cuando deje de pulverizar, siga los pasos 1-5.
Siga os passos de 1-5 quando parar de pulverizar.

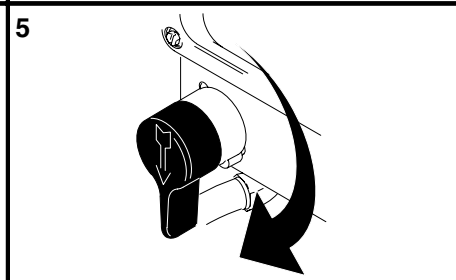
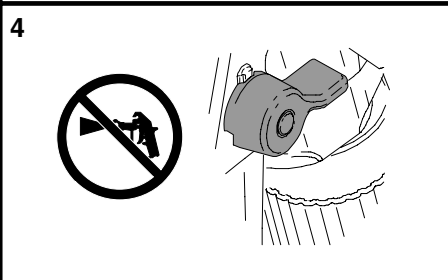
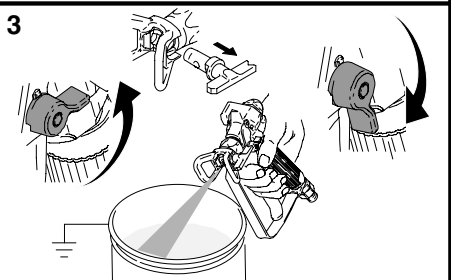
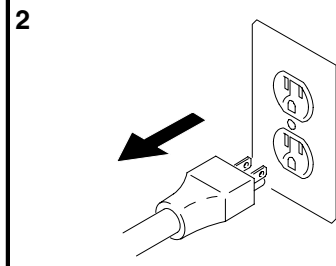
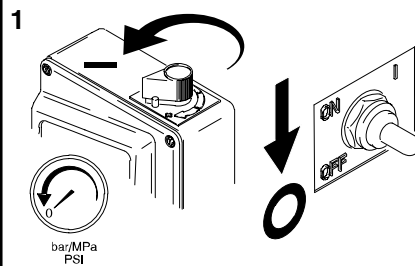

ALIGN SPRAY / ALIGNER LE JET / ALINEAR PULVERIZACIÓN / DIRIGIR O LEQUE

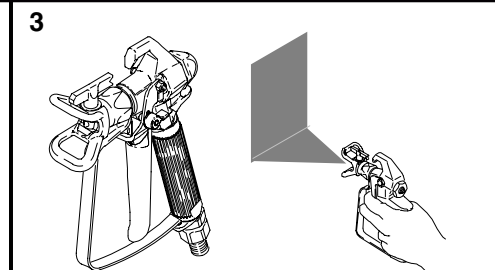
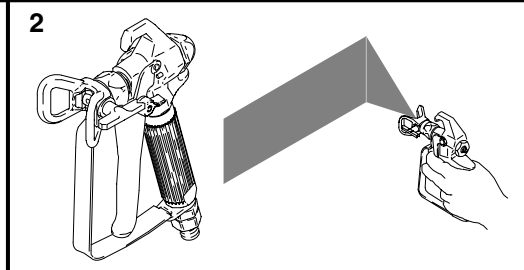
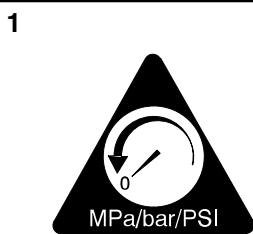

**ADJUST SPRAY / RÉGLER LE JET / AJUSTAR PULVERIZACIÓN /
REGULAR A PULVERIZAÇÃO**

1

WARNING / ADVERTENCIA / MISE EN GARDE / ADVERTENCIA

2

3

4

**CLEAR CLOG / DÉBOUCHER LA BUSE / ELIMINAR
OBSTRUCCIÓN / ELIMINAR A OBSTRUÇÃO**

**CAUTION / ATTENTION
PRECAUCIÓN / CUIDADO**

1

WARNING / ADVERTENCIA / MISE EN GARDE / ADVERTENCIA

2

3

**REPLACE NEEDLE / REMPLACER LE POINTEAU / REEMPLAZAR AGUJA /
SUBSTITUIR AGULHA**

1

2

3

4

OLD / ANCIEN / ANTIGUO / USADA



5

CLEAN / NETTOYER / LIMPIAR / LIMPAR

6

SILICON / SILICONE / SILICONA / SILICONE

GREASE / GRAISSER / LUBRICAR / LUBRIFICAR

7

NEW / NOUVEAU / NUEVO / NOVA

8

LOOSE / DESSERER / AFLOJAR / DESAPERTAR

9

Grease
Graisser
Lubricar
Lubrificar

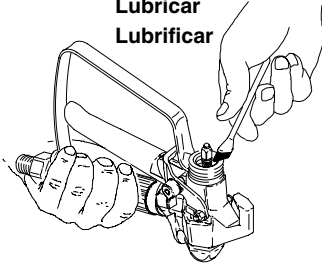

10

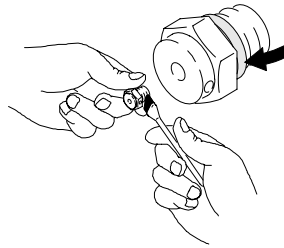

11

26-32 ft-lb (19-24 N.m)

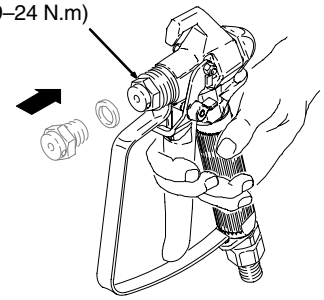

ADJUST NEEDLE / RÉGLER LE POINTEAU / AJUSTAR AGUJA / REGULAR AGULHA

1

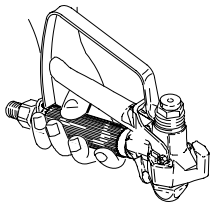

2

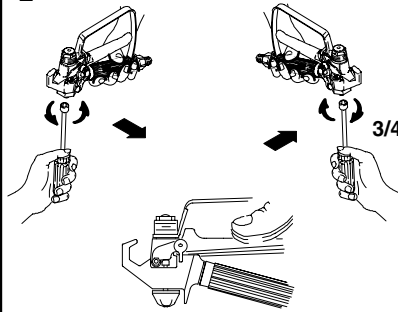

3

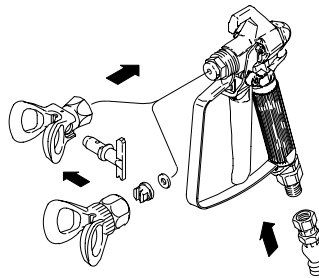

4

PRIME SPRAYER
AMORCER LE PULVÉRISATEUR
CEBAR EL PULVERIZADOR
FERRAR A BOMBA

5

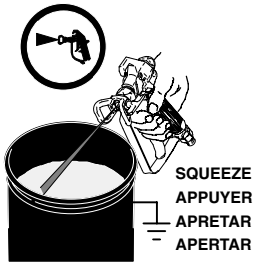

SQUEEZE
APPUYER
APRETAR
APERTAR

6

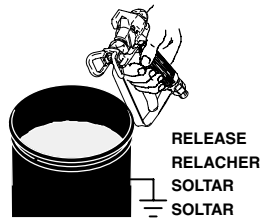

RELEASE
RELACHER
SOLTAR
SOLTAR

IF
SI
SI
SE



THEN
ALORS
DESPUÉS
ENTÃO

A



B

ADJUST NEEDLE
RÉGLER LE POINTEAU
AJUSTAR AGUJA
REGULAR AGULHA

7

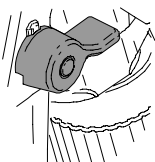

SQUEEZE
APPUYER
APRETAR
APERTAR

IF
SI
SI
SE



THEN
AORS
DESPUÉS
ENTÃO

A



B

ADJUST NEEDLE
RÉGLER LE POINTEAU
AJUSTAR AGUJA
REGULAR AGULHA

Parts Drawing / Pièces / Diagrama de piezas / Desenho das peças

243012, A

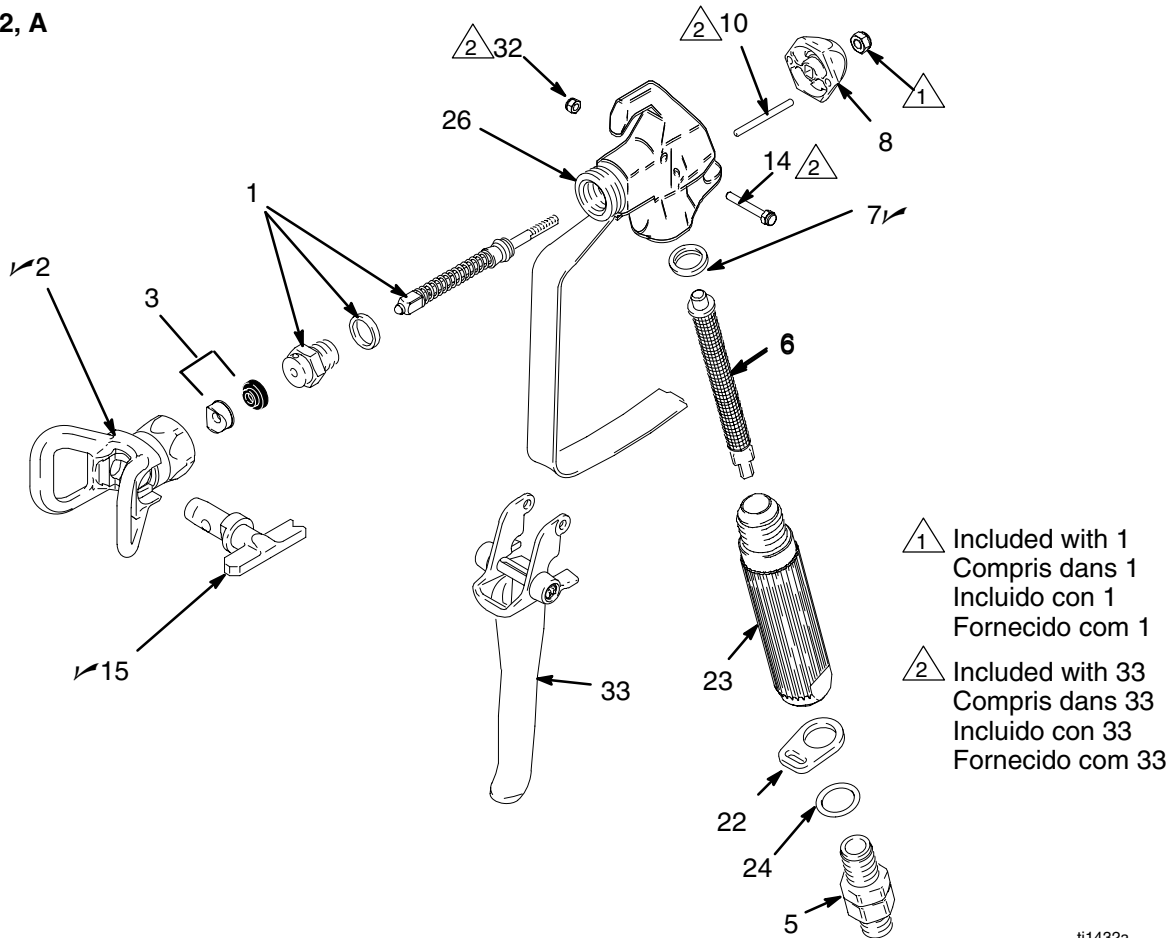

ti1432a

Parts List / Liste de pièces / Lista de piezas Lista de peças

Ref. No.	Part No.	Description	Qty.	Ref. No.	Part No.	Description	Qty.
1	243092	KIT, repair, gun	1	32	105334	NUT, lock, hex	1
2✓	237859	GUARD, tip, RAC IV, includes3	1	33	243353	Kit, repair, gun	1
3	243004	KIT, seal, 1	1	34▲	222385	WARNING CARD, notshown	1
4	195495	GUARD, trigger	1				
5	238817	KIT, swivel	1				
6✓	218131	FILTER, gun	1				
7✓	179733	SEAL, sleeve	1				
8	195395	CAP, end	1				
10	115484	PIN, actuator	2				
11	195419	HOUSING, needle	1				
14	117538	STUD, trigger	1				
15✓	221515	TIP, spray, cylinder; size 515	1				
22	113409	RETAINER, guard	1				
23	195788	HANDLE, gun	1				
24	115485	O-RING	1				
26	195390	HOUSING, fluid	1				

▲ Replacement Danger and Warning labels, tags and cards are available at no cost.
 ✓ Keep these spare parts on hand to reduce down time.
 ▲ Les étiquettes et les panonceaux de danger et de mise en garde supplémentaires sont disponibles gratuitement.
 ✓ Garder ces pièces de rechange à portée de la main pour réduire les temps morts.
 ▲ Se pueden obtener gratuitamente tarjetas y etiquetas de advertencia y de peligro, de recambio.
 ✓ Tener estas piezas a mano para reducir el período de inactividad del sistema.
 ▲ Encontram-se disponíveis gratuitamente etiquetas, rótulos e cartões de advertência e de perigo sobressalentes.
 ✓ Mantenha estas peças suplementares à mão para minimizar o tempo de paragem.

Graco Standard Warranty

Garantie Graco standard

Garantía estándar de Graco

Garantia Standard da Graco

Graco warrants all equipment referenced in this document which is manufactured by Graco and bearing its name to be free from defects in material and workmanship on the date of sale by an authorized Graco distributor to the original purchaser for use. With the exception of any special, extended, or limited warranty published by Graco, Graco will, for a period of twelve months from the date of sale, repair or replace any part of the equipment determined by Graco to be defective. This warranty applies only when the equipment is installed, operated and maintained in accordance with Graco's written recommendations.

This warranty does not cover, and Graco shall not be liable for general wear and tear, or any malfunction, damage or wear caused by faulty installation, misapplication, abrasion, corrosion, inadequate or improper maintenance, negligence, accident, tampering, or substitution of non-Graco component parts. Nor shall Graco be liable for malfunction, damage or wear caused by the incompatibility of Graco equipment with structures, accessories, equipment or materials not supplied by Graco, or the improper design, manufacture, installation, operation or maintenance of structures, accessories, equipment or materials not supplied by Graco.

This warranty is conditioned upon the prepaid return of the equipment claimed to be defective to an authorized Graco distributor for verification of the claimed defect. If the claimed defect is verified, Graco will repair or replace free of charge any defective parts. The equipment will be returned to the original purchaser transportation prepaid. If inspection of the equipment does not disclose any defect in material or workmanship, repairs will be made at a reasonable charge, which charges may include the costs of parts, labor, and transportation.

THIS WARRANTY IS EXCLUSIVE, AND IS IN LIEU OF ANY OTHER WARRANTIES, EXPRESS OR IMPLIED, INCLUDING BUT NOT LIMITED TO WARRANTY OF MERCHANTABILITY OR WARRANTY OF FITNESS FOR A PARTICULAR PURPOSE.

Graco's sole obligation and buyer's sole remedy for any breach of warranty shall be as set forth above. The buyer agrees that no other remedy (including, but not limited to, incidental or consequential damages for lost profits, lost sales, injury to person or property, or any other incidental or consequential loss) shall be available. Any action for breach of warranty must be brought within two (2) years of the date of sale.

GRACO MAKES NO WARRANTY, AND DISCLAIMS ALL IMPLIED WARRANTIES OF MERCHANTABILITY AND FITNESS FOR A PARTICULAR PURPOSE, IN CONNECTION WITH ACCESSORIES, EQUIPMENT, MATERIALS OR COMPONENTS SOLD BUT NOT MANUFACTURED BY GRACO. These items sold, but not manufactured by Graco (such as electric motors, switches, hose, etc.), are subject to the warranty, if any, of their manufacturer. Graco will provide purchaser with reasonable assistance in making any claim for breach of these warranties.

In no event will Graco be liable for indirect, incidental, special or consequential damages resulting from Graco supplying equipment hereunder, or the furnishing, performance, or use of any products or other goods sold hereto, whether due to a breach of contract, breach of warranty, the negligence of Graco, or otherwise.

FOR GRACO BRAZILIAN/CANADIAN/COLUMBIAN CUSTOMERS

The Parties acknowledge that they have required that the present document, as well as all documents, notices and legal proceedings entered into, given or instituted pursuant hereto or relating directly or indirectly hereto, be drawn up in English.

À L'ATTENTION DES CLIENTS BRÉSILIENS/CANADIENS/COLOMBIENS DE GRACO

Les parties reconnaissent avoir convenu que la rédaction du présente document sera en Anglais, ainsi que tous documents, avis et procédures judiciaires exécutés, donnés ou intentés à la suite de ou en rapport, directement ou indirectement, avec les procédures concernées.

PARA CLIENTES BRASILEIROS/CANADIANOS/COLOMBIANOS DA GRACO

As partes confirmam que solicitaram que o presente documento, assim como todos os demais documentos, notas e processos legais inseridos, atribuídos ou instituídos de acordo com o mesmo ou relacionados directa ou indirectamente com este documento, fossem redigidos em inglês.

PARA LOS CLIENTES EN BRASIL/CANADÁ/COLOMBIA

Las partes reconocen haber convenido que el presente documento, así como todos los documentos, notificaciones y procedimientos judiciales emprendidos, presentados o establecidos que tengan que ver con estas garantías directa o indirectamente, estarán redactados en inglés.

ADDITIONAL WARRANTY COVERAGE / AVENANT DE GARANTIE / COBERTURA ADICIONAL DE LA GARANTÍA / COBERTURA DE GARANTIA ADICIONAL

Graco does provide extended warranty and wear warranty for products described in the "Graco Contractor Equipment Warranty Program".

Graco accorde une garantie étendue et se porte garant des produits décrits dans le "Programme de garantie d'équipements des fournisseurs Graco".

Graco proporciona una garantía extendida y una garantía que cubre el desgaste de los productos descritos en el "Programa de Garantía del Equipo Contractor de Graco".

A Graco fornece prorrogação de garantia e garantia de desgaste para os produtos descritos no "Graco Contractor Equipment Warranty Program" (Programa de garantia de equipamento Contractor da Graco).

TO PLACE AN ORDER OR FOR SERVICE, contact your Graco distributor,
or call 1-888-541-9788 to identify the nearest distributor..

POUR PASSER COMMANDE OU DEMANDER UNE PRESTATION D'ENTRETIEN, contactez votre distributeur Graco.

PARA REMITIR UN PEDIDO O SOLICITAR SERVICIO, póngase en contacto con el distribuidor de Graco.

PARA EFECTUAR ENCOMENDAS OU PARA ASSISTÊNCIA TÉCNICA, contacte o seu distribuidor da Graco.

All written and visual data contained in this document reflects the latest product information available at the time of publication. Graco reserves the right to make changes at any time without notice.

Toutes les données écrites et visuelles figurant dans ce document reflètent les toutes dernières informations disponibles au moment de sa publication. Graco se réserve le droit de procéder à des modifications à tout moment sans avis préalable.

Todos los datos, escritos y visuales, contenidos en este documento reflejan la información más reciente sobre el producto disponible en el momento de su publicación, Graco se reserva el derecho de realizar cambios en cualquier momento, sin previo aviso.

Todo o texto e desenhos contidos neste documento reflectem as mais recentes informações sobre o produto disponíveis na altura da publicação. A Graco reserva-se o direito de efectuar alterações em qualquer momento sem aviso prévio.

Sales Offices: Minneapolis, Detroit
Foreign Offices: Belgium, Korea, Hong Kong, Japan
Bureaux des ventes: Minneapolis, Detroit
Bureaux à l'étranger: Belgique, Corée, Hong-Kong, Japon
Oficinas de vendas: Minneapolis, Detroit
Oficinas en el extranjero: Bélgica, Corea, Hong Kong, Japón
Escritórios de Vendas: Minneapolis, Detroit
Escritórios estrangeiros: Bélgica, Coreia, Hong Kong, Japão

GRACO INC. P.O. BOX 1441 MINNEAPOLIS, MN 55440-1441

<http://www.graco.com>

PRINTED IN USA 309061 12/1999, Revised 3/2003
IMPRIMÉ AUX É.-U. 309061 12/1999, Révisé 3/2003
IMPRESO EN EE.UU. 309061 12/1999, Revisado 3/2003
IMPRESSO NOS EUA 309061 12/1999, Revisado 3/2003