

Leak Detection System

311200D

For detecting leaks in your diaphragm pump system.

Not for use in explosive atmospheres.

Part No. 234576 Leak Detection System

120 psi (0.8 MPa, 8 bar) Maximum Air Input Pressure

Part No. 24B290 Leak Detector Sensor Replacement Kit



Important Safety Instructions

Read all warnings and instructions in this manual.
Save these instructions.

See page 2 for Table of Contents.







TI6850A

Contents

Warnings	2	Troubleshooting	8
Overview	3	Technical Data	9
Installation	4	Graco Standard Warranty	10
Operation	7	Graco Information	10
Maintenance	7		

Warnings

The following warnings are for the setup, use, grounding, maintenance, and repair of this equipment. The exclamation point symbol alerts you to a general warning and the hazard symbol refers to procedure-specific risk. Refer back to these warnings. Additional, product-specific warnings may be found throughout the body of this manual where applicable.

 WARNING	
	<p>ELECTRIC SHOCK HAZARD</p> <p>Improper grounding, setup, or usage of the system can cause electric shock.</p> <ul style="list-style-type: none"> • Turn off and disconnect power at main switch before disconnecting any cables and before servicing equipment. • Connect only to grounded power source. • All electrical wiring must be done by a qualified electrician and comply with all local codes and regulations. • Do not expose to rain. Store indoors.
	<p>EQUIPMENT MISUSE HAZARD</p> <p>Misuse can cause death or serious injury.</p> <ul style="list-style-type: none"> • Do not exceed the maximum working pressure or temperature rating of the lowest rated system component. See Technical Data in all equipment manuals. For complete information about your material, request MSDS from distributor or retailer. • Use fluids and solvents that are compatible with equipment wetted parts. See Technical Data in all equipment manuals. Read fluid and solvent manufacturer’s warnings. • Check equipment daily. Repair or replace worn or damaged parts immediately with genuine Graco replacement parts only. • Do not alter or modify equipment. • For professional use only. • Use equipment only for its intended purpose. Call your Graco distributor for information. • Route hoses and cables away from traffic areas, sharp edges, moving parts, and hot surfaces. • Do not kink or over bend hoses or use hoses to pull equipment. • Comply with all applicable safety regulations. • Keep children and animals away from work area. • Do not operate the unit when fatigued or under the influence of drugs or alcohol.
	<p>PERSONAL PROTECTIVE EQUIPMENT</p> <p>You must wear appropriate protective equipment when operating, servicing, or when in the operating area of the equipment to help protect you from serious injury, including eye injury, inhalation of toxic fumes, burns, and hearing loss. This equipment includes but is not limited to:</p> <ul style="list-style-type: none"> • Protective eyewear • Clothing and respirator as recommended by the fluid and solvent manufacturer • Gloves • Hearing protection

Overview

Usage

The leak detector monitors air operated double diaphragm pumps for diaphragm rupture or other leaks that may contaminate the fluid being pumped. The system is made up of a main control box and two liquid detection sensors. The sensors are screwed into the air side of each diaphragm on the pump. When liquid is sensed by either one of the sensors, an alarm will sound, indicating a diaphragm rupture has occurred. The control box also has the ability to control an external device such as an alarm, light, or an air solenoid via an onboard relay.

During normal operation, the LED indicators on the control box and each sensor will flash once per second, indicating proper operation. If a system fault or a leak is detected, an alarm will sound and the LED on the control box will blink three times per second. See table, page 8.



Always disconnect the power supply from the control box prior to cleaning the pump.

Component Identification and Description

Before you install the system, you should be familiar with the parts discussed in the following paragraphs.

Sensors

The sensors are mounted on the pump to detect liquid on the air side of the diaphragm. See FIG. 1, FIG. 2, and FIG. 3.

The sensors use two methods of detection: optical and conductive.

Sensors	Definition
Conductive	The two metal pins on the sensors. Controls the blue light and its signal is the white wire.
Optical	The plastic dome in the center of the sensor. Controls the yellow light and its signal is the green wire.

Having both conductive and optical sensors allows the sensor to detect as many liquids as possible. When both sensors are in air, both lights (blue and yellow) flash once per second.

When the sensor is immersed in a conductive liquid, the blue LED will stop flashing. When the sensor is immersed in a liquid compatible with the optical sensor the yellow LED will stop flashing.

Control Box

The control box powers and monitors the sensors and sound the alarm when a leak is detected.

The control box powers and reads the sensors every second. If the sensors detect liquid, the control box will alarm and set it's fault relay.

Relay

The relay has two sets of contacts that can be used to indicate an error by turning off a valve, lighting a light, etc. The contacts are located at J4 on the circuit board. See FIG. 5.

There are two separate sets of Common, NO/NC contacts labeled CRS.

- C (Common)
- R is Reset, which is connected to Common during normal operation. (NO)
- S is Set, which is connected to Common when an error is detected. (NC)

For example, if an air valve was held open during normal operation, the power to the valve would enter at C and exit at R. During normal operation C and R are connected and would open if liquid were detected by a sensor. This would stop the pump. Power must be maintained to the control box for the pump to operate. When the control box loses power it will set the relay. Both sets of CRS contacts are floating contacts and are electrically isolated from each other and the electronics on the control board. They do not supply power and should be used as a switch only.

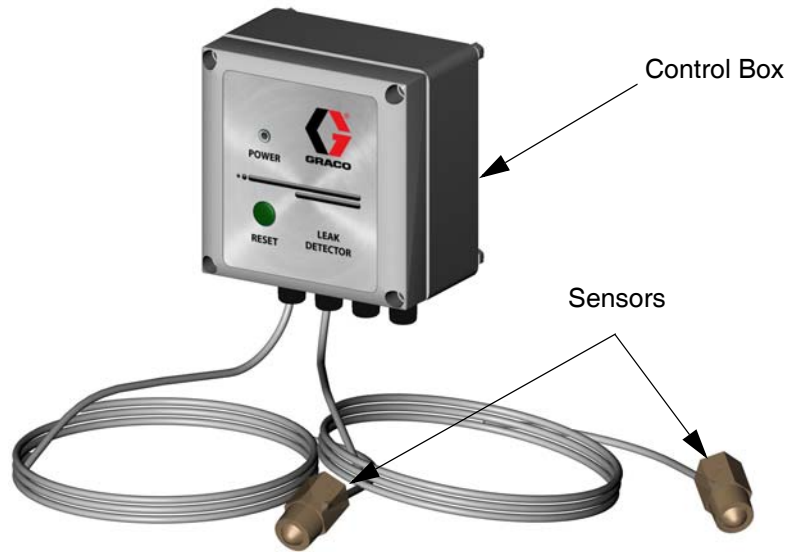

T16850A

FIG. 1. Leak Detection System

Installation

Install the Sensors

 To replace a sensor, order Part No. 24B290 Leak Detector Sensor Replacement Kit. The kit includes one sensor. To install the kit, first shut off power to the control box. Follow steps 2-7 below, and step 10 on page 6.

1. Mount the leak detector control box in a convenient location. See FIG. 3.
2. Remove plugs from the pump, if plugs are present.
3. See FIG. 2. Remove the sensor caps (A). Screw the sensors (B) into the pump. Use thread sealant, as needed. See FIG. 3.

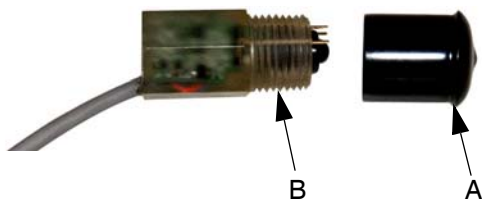
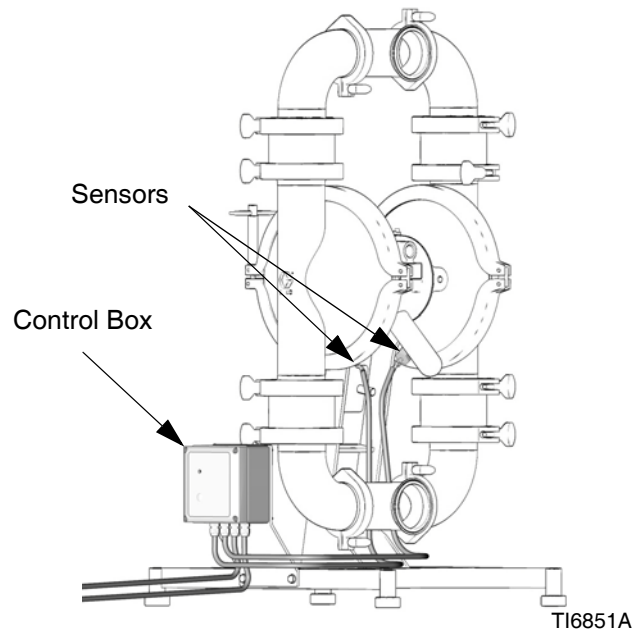

FIG. 2. Sensor and Cap



T16851A

FIG. 3. Typical Installation

⚠	✋	⚡				
<p>If installing Part No. 24B290 Leak Detector Sensor Replacement Kit, shut off power to the control box before opening the cover.</p>						

4. Unscrew four screws (C) and remove the cover (D) from the control box (E). See FIG. 4.

5. Route the sensor wires into the control box through the fittings (F) at the bottom of the box. Tighten the fittings.
6. Attach the lead wires to the sensor terminals as shown in FIG. 4.
7. Plug the sensor terminals to the respective connectors on the circuit board (located on the inside of the cover). See FIG. 5.

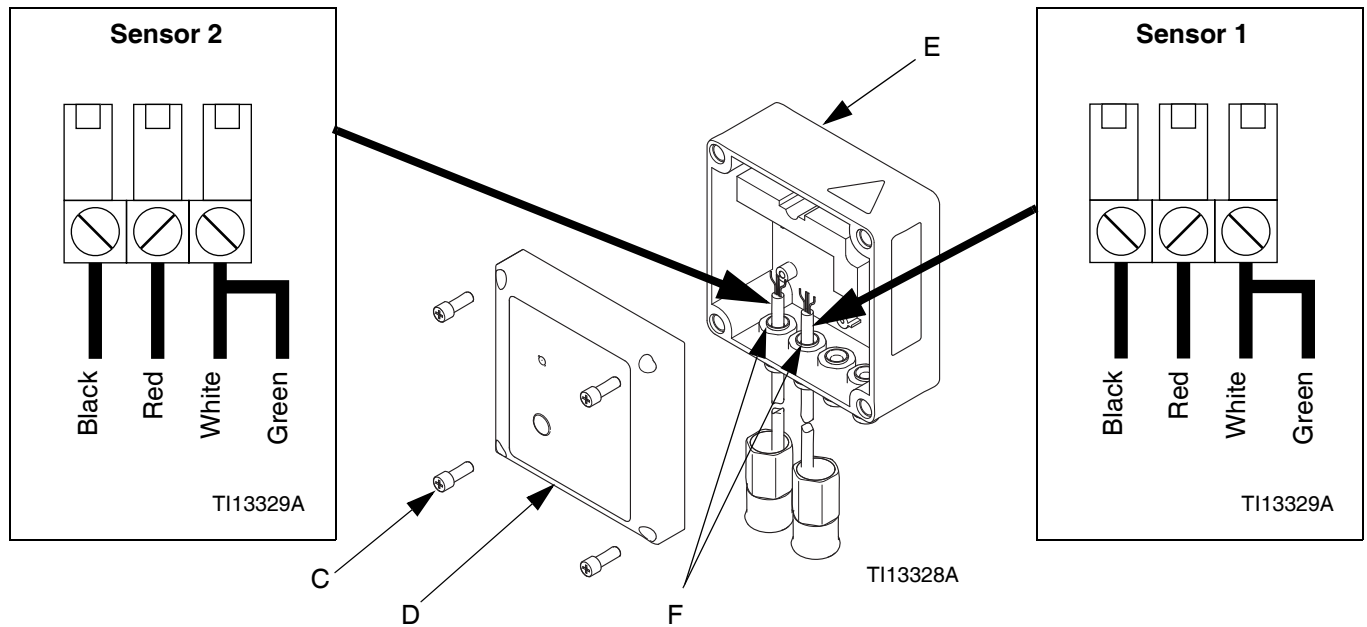

FIG. 4. Sensor Wire Connections in Control Box

Connect Power

<p>Connect the leak detector to a 24 VDC power source OR a 110 VAC or 230 VAC power source. Do not connect to both.</p>						

8. The control box can be powered by 230 VAC, 110 VAC, or 24 VDC.

AC power is connected to J6 on the circuit board. The ground connection is the pin between the pins N and 110. See FIG. 5.

- To operate on 230 VAC, connect between pins marked N and 220.
- To operate from 110 VAC, connect between pins marked N and 110.
- To operate from 24 VDC, connect to J1. J1 is marked for positive and negative polarity. Disconnect any power to the AC connector J6 if the system is to be powered by 24 VDC. See FIG. 5.

9. Connect an external ACPRH, air valve, etc. to the internal relay (CRS), if desired, using J4. See FIG. 5.

- C (Common)
- R is Reset, which is connected to Common during normal operation. (NO)
- S is Set, which is connected to Common when an error is detected. (NC)

10. Reinstall the cover (D) using the four screws (C).

Grounding

--	--	--	--	--	--	--

- Follow the instructions in your pump manual to ground the Graco diaphragm pump system and check its electrical grounding continuity.
- When the Leak Detector is powered by 230 VAC or 110 VAC, ground the Leak Detector by connecting the ground wire to terminal G on terminal J6. See FIG. 5.

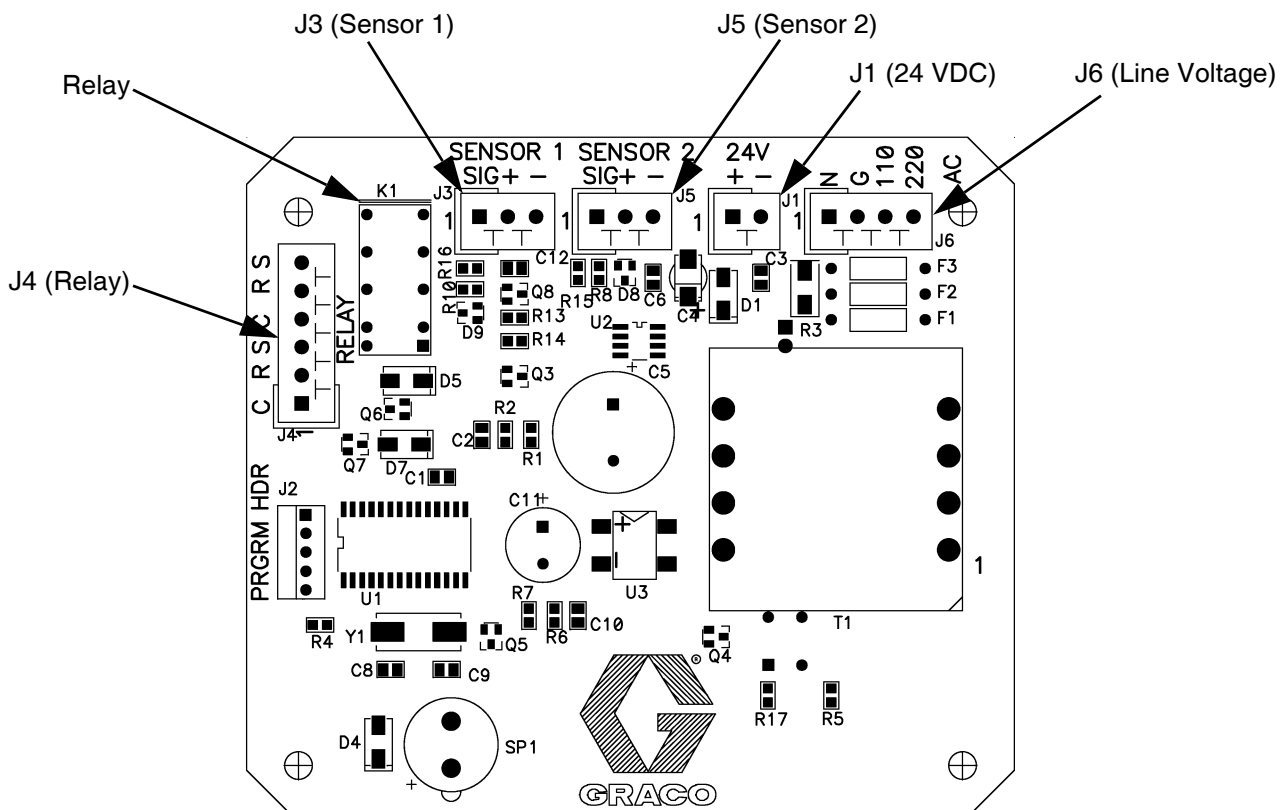

FIG. 5. Circuit Board Terminal Connections

Operation

Leak Detector Operation

During normal operation, the LED on the leak detector control box and the sensors will flash once per second.

If an error or a diaphragm rupture occurs, the LED and sensors will flash three times per second and the alarm will sound. The relay will trip and change state. To stop the alarm, press the reset button or remove power for 30 seconds. See FIG. 6.

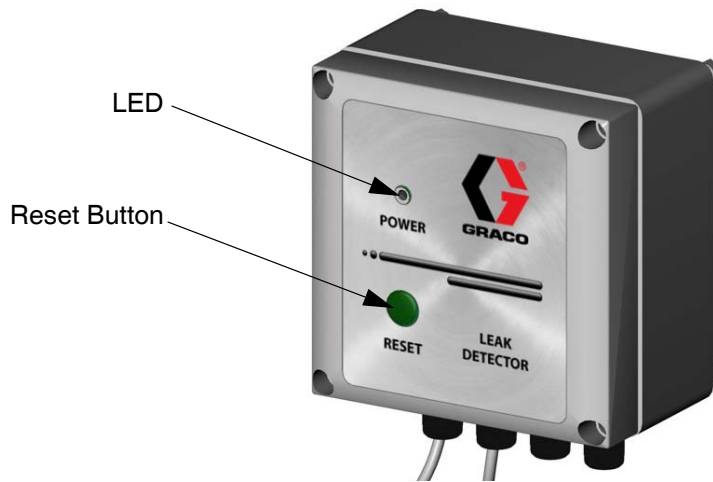

FIG. 6. LED and Reset Button

Maintenance

Clean Sensors

Clean the sensors whenever the pump is disassembled for cleaning or inspection.



Always disconnect the power supply from the control box prior to cleaning the pump.

Test to ensure proper operation

1. Verify non-fault condition. With power to the control box, verify that:
 - the LED indicator on the control box flashes once per second.
 - both the yellow and blue LED indicators on each sensor flash once per second.
2. Verify operation of the Optical sensor. Submerge each sensor separately in a non-transparent fluid such as milk. Verify that:
 - the alarm sounds.

- the yellow LED on this sensor stops flashing.
 - the LED on the control box blinks three times per second.
 - the relay is set and performs the intended operation (i.e. shuts down the pump).
3. Verify operation of the Conductive sensor. Submerge each sensor separately in a conductive fluid such as water. Verify that:
 - the alarm sounds.
 - the blue LED on this sensor stops flashing.
 - the LED on the control box blinks three times per second.
 - the relay is set and performs the intended operation (i.e. shuts down the pump).
 4. Verify loss-of-power condition: Disconnect the power supply from the control box. Verify that:
 - the relay is set and performs the intended operation (i.e. shuts down the pump)

Troubleshooting

Problem	Cause	Solution
Light flashes 3/sec and alarm sounds 1/sec.	Sensor has detected liquid.	<p>Determine which sensor has detected the liquid.</p> <p>Inspect the diaphragm on the side which liquid has been detected.</p> <p>Replace diaphragm as necessary.</p> <p>To assure proper sensor operation, clean and dry the sensor head and the air side of the diaphragm pump.</p>
Light flashes 3/sec and alarm sounds 3/sec.	One of the sensors is unplugged or has failed.	<p>Remove the cover from the leak detector control box.</p> <p>Inspect the sensor connection for proper contacts and connections.</p> <p>If the problem persists, replace the sensor(s) as required.</p>
Light flashes 3/sec and alarm sounds 8/sec.	The reset button is stuck in the down position.	<p>Remove any obstruction possibly depressing the reset button.</p> <p>If no obstruction exists, remove the cover and inspect the reset button for anything holding it in the down position.</p>
Relay is set and light flashes 3/sec until reserve power is gone.	Loss of power to the leak detection system.	<p>Once main power is restored, the alarm will clear and the system will resume normal operation. If the control box relay is wired to the air supply to the pump, the control box must be powered for the pump to work.</p>

Technical Data

Input voltage range	12-28 VDC
	100-130 VAC, 50/60 Hz
	190-260 VAC, 50/60 Hz
Maximum power consumption	3 W
Relay contact rating, 230 VAC	60 W, 62.5 VA
Maximum sensor pressure	200 psi (1.4 MPa, 14 bar)
Operating temperature range	0-104°F (-18-40°C)
Maximum sensor line length	2 ft (.6 m)

Type of liquids that can be detected: water, oil, or any liquid compatible with polysulphone.

Graco Standard Warranty

Graco warrants all equipment referenced in this document which is manufactured by Graco and bearing its name to be free from defects in material and workmanship on the date of sale to the original purchaser for use. With the exception of any special, extended, or limited warranty published by Graco, Graco will, for a period of twelve months from the date of sale, repair or replace any part of the equipment determined by Graco to be defective. This warranty applies only when the equipment is installed, operated and maintained in accordance with Graco's written recommendations.

This warranty does not cover, and Graco shall not be liable for general wear and tear, or any malfunction, damage or wear caused by faulty installation, misapplication, abrasion, corrosion, inadequate or improper maintenance, negligence, accident, tampering, or substitution of non-Graco component parts. Nor shall Graco be liable for malfunction, damage or wear caused by the incompatibility of Graco equipment with structures, accessories, equipment or materials not supplied by Graco, or the improper design, manufacture, installation, operation or maintenance of structures, accessories, equipment or materials not supplied by Graco.

This warranty is conditioned upon the prepaid return of the equipment claimed to be defective to an authorized Graco distributor for verification of the claimed defect. If the claimed defect is verified, Graco will repair or replace free of charge any defective parts. The equipment will be returned to the original purchaser transportation prepaid. If inspection of the equipment does not disclose any defect in material or workmanship, repairs will be made at a reasonable charge, which charges may include the costs of parts, labor, and transportation.

THIS WARRANTY IS EXCLUSIVE, AND IS IN LIEU OF ANY OTHER WARRANTIES, EXPRESS OR IMPLIED, INCLUDING BUT NOT LIMITED TO WARRANTY OF MERCHANTABILITY OR WARRANTY OF FITNESS FOR A PARTICULAR PURPOSE.

Graco's sole obligation and buyer's sole remedy for any breach of warranty shall be as set forth above. The buyer agrees that no other remedy (including, but not limited to, incidental or consequential damages for lost profits, lost sales, injury to person or property, or any other incidental or consequential loss) shall be available. Any action for breach of warranty must be brought within two (2) years of the date of sale.

GRACO MAKES NO WARRANTY, AND DISCLAIMS ALL IMPLIED WARRANTIES OF MERCHANTABILITY AND FITNESS FOR A PARTICULAR PURPOSE, IN CONNECTION WITH ACCESSORIES, EQUIPMENT, MATERIALS OR COMPONENTS SOLD BUT NOT MANUFACTURED BY GRACO. These items sold, but not manufactured by Graco (such as electric motors, switches, hose, etc.), are subject to the warranty, if any, of their manufacturer. Graco will provide purchaser with reasonable assistance in making any claim for breach of these warranties.

In no event will Graco be liable for indirect, incidental, special or consequential damages resulting from Graco supplying equipment hereunder, or the furnishing, performance, or use of any products or other goods sold hereto, whether due to a breach of contract, breach of warranty, the negligence of Graco, or otherwise.

FOR GRACO CANADA CUSTOMERS

The Parties acknowledge that they have required that the present document, as well as all documents, notices and legal proceedings entered into, given or instituted pursuant hereto or relating directly or indirectly hereto, be drawn up in English. Les parties reconnaissent avoir convenu que la rédaction du présente document sera en Anglais, ainsi que tous documents, avis et procédures judiciaires exécutés, donnés ou intentés, à la suite de ou en rapport, directement ou indirectement, avec les procédures concernées.

Graco Information

TO PLACE AN ORDER, contact your Graco distributor or call to identify the nearest distributor.

Phone: 612-623-6921 **or Toll Free:** 1-800-328-0211 **Fax:** 612-378-3505

*All written and visual data contained in this document reflects the latest product information available at the time of publication.
Graco reserves the right to make changes at any time without notice.*

This manual contains English. MM 311200

Graco Headquarters: Minneapolis
International Offices: Belgium, China, Japan, Korea

GRACO INC. P.O. BOX 1441 MINNEAPOLIS, MN 55440-1441

Copyright 2005, Graco Inc. is registered to I.S. EN ISO 9001

www.graco.com

Revised 7/2017