

Dura-Flo™ Lowers

311825P

EN

Carbon Steel or Stainless Steel Lowers. For use on Graco pumps, sprayers and fluid handling systems. For professional use only.

Dura-Flo 1800 (430 cc) Lowers

Dura-Flo 2400 (580 cc) Lowers



Important Safety Instructions

Read all warnings and instructions in this manual.
Save these instructions.

See page 3 for model information, including maximum working pressure.

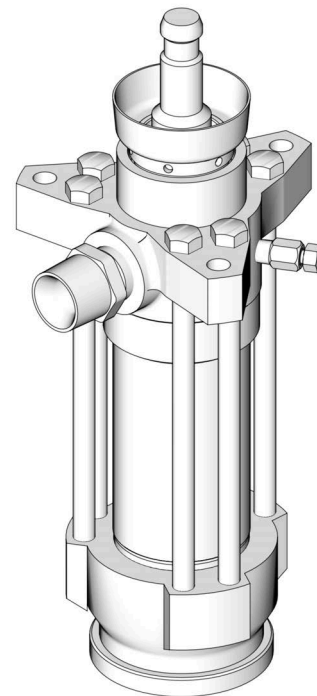

TI8341b

Contents

Models	3
430cc Lowers	3
580cc Lowers	4
Warnings	5
Repair	7
Pressure Relief Procedure	7
Required Tools	7
Disassembly	8
Reassembly	9
Parts	11
Dura-Flo 1800 (430 cc) Lowers	12
Dura-Flo 2400 (580 cc) Lowers	14
Repair Kits	16
UHMWPE and PTFE Packings	16
PTFE and Leather Packings	17
PTFE Packings	18
UHMWPE and Leather Packings	19
Dimensions	22
Technical Specifications	22
California Proposition 65	23
Graco Standard Warranty	24
Graco Information	24

Models

Severe-Duty: For wear and corrosion resistance in addition to low friction characteristics.

MaxLife: MaxLife is a proprietary Graco hard coating for piston pump rods and cylinders. MaxLife provides a smooth and harder wear surface with no porosity while providing excellent corrosion/chemical resistance.

430cc Lowers





Lower Part	Body	Size	Rod Construction	Cylinder Construction	Ball Construction	Seat Construction	Piston Packings	Throat Packings	Maximum Fluid Working Pressure
222796	CS	430cc	SST with Severe-Duty	SST with Severe-Duty	SST	Tungsten Carbide	3 15% glass-filled PTFE/2 leather	3 PTFE/2 leather	32 MPa (324 bar, 4700 psi)
24W644	CS	430cc	SST with Severe-Duty	SST with Severe-Duty	SST	Tungsten Carbide	3 UHMWPE/ 2 leather	3 UHMWPE /2 leather	
222988	CS	430cc	SST with Severe-Duty	SST with Severe-Duty	SST	Tungsten Carbide	5 15% glass-filled PTFE	5 PTFE	
222805	SS	430cc	SST with Severe-Duty	SST with Severe-Duty	SST	Tungsten Carbide	3 UHMWPE/ 2 15% glass-filled PTFE	3 UHMWPE /2 PTFE	
241956	SS	430cc	SST with Ceramic	SST with Severe-Duty	Tungsten Carbide	Tungsten Carbide	3 UHMWPE/ 2 15% glass-filled PTFE	3 UHMWPE /2 PTFE	
246925	SS	430cc	SST with Severe-Duty	SST with Severe-Duty	Tungsten Carbide	Tungsten Carbide	3 UHMWPE/ 2 leather	3 UHMWPE /2 leather	
246987	SS	430cc	SST with Severe-Duty	SST with Severe-Duty	Silicone Nitride	Tungsten Carbide	3 UHMWPE/ 2 leather	3 UHMWPE /2 leather	
246988	SS	430cc	SST with Ceramic	SST with Severe-Duty	Silicone Nitride	Tungsten Carbide	3 UHMWPE/ 2 leather	4 leather/3 UHMWPE	
249992	SS	430cc	SST with MaxLife	SST with MaxLife	Silicone Nitride	Tungsten Carbide	3 UHMWPE/ 2 oil-filled UHMWPE	4 leather/3 UHMWPE	
687055	SS	430cc	SST with Severe-Duty	SST with Severe-Duty	SST	Tungsten Carbide	3 UHMWPE/ 2 carbon-filled PTFE	3 UHMWPE /2 carbon-filled PTFE	
C59703	SS	430cc	SST with Severe-Duty	SST with Severe-Duty	Tungsten Carbide	Tungsten Carbide	3 UHMWPE/ 2 15% glass-filled PTFE	3 UHMWPE /2 PTFE	
L430CM	CS	430cc	SST with MaxLife	SST with MaxLife	Silicone Nitride	Tungsten Carbide	3 UHMWPE/ 2 oil-filled UHMWPE	4 leather/3 UHMWPE	
L430CS	CS	430cc	SST with Severe-Duty	SST with Severe-Duty	SST	Tungsten Carbide	3 UHMWPE/ 2 15% glass-filled PTFE	3 UHMWPE /2 PTFE	
L430C2	CS	430cc	SST with Chromex	SST with Severe-Duty	SST	Tungsten Carbide	UHMWPE	UHMWPE	
L430SS	SS	430cc	SST with Severe-Duty	SST with Severe-Duty	SST	Tungsten Carbide	3 UHMWPE/ 2 15% glass-filled PTFE	3 UHMWPE /2 PTFE	
L430SM	SS	430cc	SST with MaxLife	SST with MaxLife	Silicone Nitride	Tungsten Carbide	3 UHMWPE/ 2 oil-filled UHMWPE	4 leather/3 UHMWPE	
L430S1	SS	430cc	SST with Chromex	SST with Severe-Duty	SST	Tungsten Carbide	UHMWPE	UHMWPE	
L430S2	SS	430cc	SST with Chromex	SST with Severe-Duty	SST	Tungsten Carbide	UHMWPE	UHMWPE	





580cc Lowers

Lower Part	Body	Size	Rod Construction	Cylinder Construction	Ball Construction	Seat Construction	Piston Packings	Throat Packings	Maximum Fluid Working Pressure
222801	CS	580cc	SST with Severe-Duty	SST with Severe-Duty	SST	Tungsten Carbide	3 15% glass-filled PTFE/2 leather	3 PTFE/2 leather	32 MPa (324 bar, 4700 psi)
222991	CS	580cc	SST with Severe-Duty	SST with Severe-Duty	SST	Tungsten Carbide	4 leather/1 15% glass-filled PTFE	4 leather/1 PTFE	
222992	CS	580cc	SST with Severe-Duty	SST with Severe-Duty	SST	Tungsten Carbide	5 15% glass-filled PTFE	5 PTFE	
C59798	CS	580cc	SST with Severe-Duty	SST with Severe-Duty	Tungsten Carbide	Tungsten Carbide	3 15% glass-filled PTFE/2 leather	3 PTFE/2 leather	
222803	SS	580cc	SST with Severe-Duty	SST with Severe-Duty	SST	Tungsten Carbide	3 UHMWPE/ 2 15% glass-filled PTFE	3 UHMWPE /2 PTFE	
222993	SS	580cc	SST with Severe-Duty	SST with Severe-Duty	SST	Tungsten Carbide	3 15% glass-filled PTFE/2 leather	3 PTFE/2 leather	
222994	SS	580cc	SST with Severe-Duty	SST with Severe-Duty	SST	Tungsten Carbide	5 15% glass-filled PTFE	5 PTFE	
236226	SS	580cc	SST with Severe-Duty	SST with Severe-Duty	SST	Tungsten Carbide	3 UHMWPE/ 2 15% glass-filled PTFE	3 UHMWPE /2 PTFE	
236230	SS	580cc	SST with Severe-Duty	SST with Severe-Duty	SST	Tungsten Carbide	4 leather/1 15% glass-filled PTFE	4 leather/1 PTFE	
241648	SS	580cc	SST with Severe-Duty	SST with Severe-Duty	SST	Tungsten Carbide	3 UHMWPE/ 2 carbon-filled PTFE	3 UHMWPE /2 carbon-filled PTFE	
249991	SS	580cc	SST with Max-Life	SST with Max-Life	Silicone Nitride	Tungsten Carbide	3 UHMWPE/ 2 oil-filled UHMWPE	4 leather/ 3 UHMWPE	
15F298	SS	580cc	SST with Severe-Duty	SST with Severe-Duty	Silicone Nitride	Tungsten Carbide	3 PTFE/2 leather	4 leather/ 3 UHMWPE	
L580CS	CS	580cc	SST with Severe-Duty	SST with Severe-Duty	SST	Tungsten Carbide	3 UHMWPE/ 2 glass-filled PTFE	3 UHMWPE /2 PTFE	
L580SS	SS	580cc	SST with Severe-Duty	SST with Severe-Duty	SST	Tungsten Carbide	3 UHMWPE/ 2 glass-filled PTFE	3 UHMWPE /2 PTFE	
L580SM	SS	580cc	SST with Max-Life	SST with Max-Life	Silicone Nitride	Tungsten Carbide	3 UHMWPE/ 2 oil-filled UHMWPE	4 leather/ 3 UHMWPE	
L580S1	SS	580cc	SST with Chromex	SST with Chromex	SST	Tungsten Carbide	UHMWPE	UHMWPE	
L580S2	SS	580cc	SST with Chromex	SST with Severe-Duty	SST	Tungsten Carbide	UHMWPE	UHMWPE	
L580S3	SS	580cc	SST with Max-Life	SST with Max-Life	Silicone Nitride	Tungsten Carbide	3 UHMWPE/ 2 PTFE	3 UHMWPE/ 2 PTFE	
L580S4	SS	580cc	SST with Chromex	SST with Severe-Duty	SST	Tungsten Carbide	3 UHMWPE/ 2 PTFE	3 UHMWPE/ 2 PTFE	
L580C2	CS	580cc	SST with Chromex	SST with Chromex	SST	Tungsten Carbide	UHMWPE	UHMWPE	
L580S5	SS	580cc	SST with Max-Life	SST with Max-Life	Tungsten Carbide	Tungsten Carbide	3 UHMWPE/ 2 PTFE	3 UHMWPE/ 2 PTFE	

Warnings

The following warnings are for the setup, use, grounding, maintenance, and repair of this equipment. The exclamation point symbol alerts you to a general warning and the hazard symbol refers to procedure-specific risk. Refer back to these warnings. Additional, product-specific warnings may be found throughout the body of this manual where applicable.

 WARNING	
	<p>FIRE AND EXPLOSION HAZARD</p> <p>Flammable fumes, such as solvent and paint fumes, in work area can ignite or explode. To help prevent fire and explosion:</p> <ul style="list-style-type: none"> • Use equipment only in well ventilated area. • Eliminate all ignition sources; such as pilot lights, cigarettes, portable electric lamps, and plastic drop cloths (potential static arc). • Keep work area free of debris, including solvent, rags and gasoline. • Do not plug or unplug power cords, or turn power or light switches on or off when flammable fumes are present. • Ground all equipment in the work area. See Grounding instructions. • Use only grounded hoses. • Hold gun firmly to side of grounded pail when triggering into pail. • If there is static sparking or you feel a shock, stop operation immediately. Do not use equipment until you identify and correct the problem. • Keep a working fire extinguisher in the work area.
	<p>SKIN INJECTION HAZARD</p> <p>High-pressure fluid from gun, hose leaks, or ruptured components will pierce skin. This may look like just a cut, but it is a serious injury that can result in amputation. Get immediate surgical treatment.</p> <ul style="list-style-type: none"> • Do not point gun at anyone or at any part of the body. • Do not put your hand over the spray tip. • Do not stop or deflect leaks with your hand, body, glove, or rag. • Do not spray without tip guard and trigger guard installed. • Engage trigger lock when not spraying. • Follow Pressure Relief Procedure in this manual, when you stop spraying and before cleaning, checking, or servicing equipment.
	<p>EQUIPMENT MISUSE HAZARD</p> <p>Misuse can cause death or serious injury.</p> <ul style="list-style-type: none"> • Do not operate the unit when fatigued or under the influence of drugs or alcohol. • Do not exceed the maximum working pressure or temperature rating of the lowest rated system component. See Technical Data in all equipment manuals. • Use fluids and solvents that are compatible with equipment wetted parts. See Technical Data in all equipment manuals. Read fluid and solvent manufacturer's warnings. For complete information about your material, request MSDS forms from distributor or retailer. • Check equipment daily. Repair or replace worn or damaged parts immediately with genuine manufacturer's replacement parts only. • Do not alter or modify equipment. • Use equipment only for its intended purpose. Call your distributor for information. • Route hoses and cables away from traffic areas, sharp edges, moving parts, and hot surfaces. • Do not kink or over bend hoses or use hoses to pull equipment. • Keep children and animals away from work area. • Comply with all applicable safety regulations.

 WARNING	
	<p>MOVING PARTS HAZARD</p> <p>Moving parts can pinch or amputate fingers and other body parts.</p> <ul style="list-style-type: none"> • Keep clear of moving parts. • Do not operate equipment with protective guards or covers removed. • Pressurized equipment can start without warning. Before checking, moving, or servicing equipment, follow the Pressure Relief Procedure in this manual. Disconnect power or air supply.
	<p>TOXIC FLUID OR FUMES HAZARD</p> <p>Toxic fluids or fumes can cause serious injury or death if splashed in the eyes or on skin, inhaled, or swallowed.</p> <ul style="list-style-type: none"> • Read MSDS's to know the specific hazards of the fluids you are using. • Store hazardous fluid in approved containers, and dispose of it according to applicable guidelines. • Always wear impervious gloves when spraying or cleaning equipment.
	<p>PERSONAL PROTECTIVE EQUIPMENT</p> <p>You must wear appropriate protective equipment when operating, servicing, or when in the operating area of the equipment to help protect you from serious injury, including eye injury, inhalation of toxic fumes, burns, and hearing loss. This equipment includes but is not limited to:</p> <ul style="list-style-type: none"> • Protective eyewear • Clothing and respirator as recommended by the fluid and solvent manufacturer • Gloves • Hearing protection

Repair

Pressure Relief Procedure

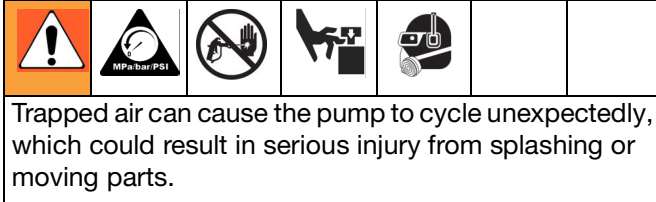

1. Engage trigger lock.
2. Shutoff the pump:
 - a. *For air-powered pumps*, close the bleed-type master air valve.
 - b. *For hydraulic-powered pumps*, close the supply line shutoff valve (U) first, then close the return line shutoff valve (V).
3. Disengage the trigger lock.
4. Hold a metal part of the gun firmly to a grounded metal pail. Trigger the gun to relieve pressure.
5. Engage the trigger lock.
6. Open all fluid drain valves in the system, having a waste container ready to catch drainage. Leave drain valve(s) open until you are ready to spray again.
7. If you suspect the spray tip or hose is clogged or that pressure has not been fully relieved after following the steps above, **VERY SLOWLY** loosen tip guard retaining nut or hose end coupling to relieve pressure gradually, then loosen completely. Clear hose or tip obstruction.

Required Tools

- Set of socket wrenches
- Set of adjustable wrenches
- 24 in. adjustable wrench
- Torque wrench
- Rubber mallet
- Arbor press
- Soft wooden block (approx. 1 square foot in size)
- Large vise, with soft jaws
- Thread lubricant
- Anti-seize lubricant 222955
- Loctite® 2760™ or equivalent

Disassembly

Lay out all the removed parts in sequence, to ease reassembly. Clean all parts with a compatible solvent and inspect them for wear or damage. Refer to FIG. 1.

 Repair Kits are available to replace the throat (T) and piston (P) packings, and to replace the o-rings and cylinder seals. For the best results, use all the new parts in the kit. Kit parts are marked with an asterisk, for example (11*). These kits also can be used to convert the lower to different packing materials. Refer to pages 16-20.

1. Flush the pump, if possible. Stop the pump at the bottom of its stroke. Relieve the pressure, page 7.
2. Disconnect the lower from the motor. See your separate pump assembly manual.
3. Stand the lower upright in a large vise. Loosen, but do not remove, the packing nut (3). Remove the six long cap screws (20).
4. Lift the outlet housing (19) straight up off the lower. Be careful not to scratch the displacement rod (1) while removing the housing.
5. Lift the cylinder (7), displacement rod (1), and piston assembly off the intake housing (17).
6. Remove the seal (6), ball guide (14), intake ball (16), intake seat housing (15), and o-ring (27) from the intake housing (17). Inspect the ball (16) and the ball seat (A) on the housing (15) for wear or damage.
7. Remove the seal (6) from the bottom of the outlet housing (19). Unscrew the packing nut (3). Remove the glands and v-packings (T) from the housing. Do not remove the outlet fitting (4) and o-ring (5) unless they need replacement.
8. Unscrew the bleeder valve plug (35) completely from the valve body (34). Clean the valve threads and the bleed hole. It is not necessary to remove the valve body.

CAUTION

To reduce the possibility of costly damage to the rod (1) and cylinder (7), first place the cylinder on a soft block of wood. Always use a rubber mallet or an arbor press to drive the rod (1) out of the cylinder (7). Never use a hammer to drive the rod.

9. Stand the cylinder (7) upright on a wooden block. Using a rubber mallet or an arbor press, drive the displacement rod (1) and piston assembly down into the cylinder as far as possible, then place the cylinder on its side and continue to drive the rod out the bottom until the piston comes free. Pull the rod and piston from the cylinder, being careful not to scratch the rod or cylinder.
 10. Put the flats of the piston seat housing (12) in a vise. Unscrew the rod (1) from the housing (12), leaving the ball guide (9) assembled to the rod. Be careful that the piston ball (10) doesn't fall as you separate the housing (12) and ball guide (9).
 11. Remove the glands and v-packings (P) from the piston seat housing (12). Inspect the ball (10) and ball seat (B) on the housing (12) for wear or damage.
 12. Inspect the outer surface of the displacement rod (1) and the inner surface of the cylinder (7) for scoring or wear; replace if damaged. If replacing the rod, remove the ball guide (9) (see step 13).
-  **Do not** remove the ball guide (9) from the displacement rod (1) unless either part needs replacement.
13. Place the flats of the ball guide (9) in a vise. Using a 24 in. adjustable wrench or 3/4 in. drive socket, unscrew the rod (1) from the ball guide.

Reassembly

1. If the ball guide (9) was removed, place the flats of the displacement rod (1) in a vise. Apply anti-seize lubricant 222955 to the threads and mating faces of the rod and the ball guide. Screw the ball guide onto the rod, hand tight. Remove from the vise. See FIG. 1.
2. Install the piston packings (P) on the piston (12) in the correct order for your lower, see **Repair Kits**, pages 16-20. Install the v-packings one at a time with the lips facing up.

 To convert the lower to a different packing material, see pages 16-20.

3. Apply anti-seize lubricant 222955 to the threads and mating faces of the ball guide (9) and piston seat housing (12). Place the flats of the piston seat housing in a vise. Place the ball (10) on the piston seat. Screw the assembled rod (1) and ball guide (9) onto the piston assembly hand tight, then torque to 459-481 N•m (338-354 ft-lb).

CAUTION
To reduce the possibility of costly damage to the rod (1) and cylinder (7), first place the cylinder on a soft block of wood. Always use a rubber mallet or an arbor press to drive the rod (1) into the cylinder (7). Never use a hammer to drive the rod.

4. Use an arbor press to reinstall the rod (1) into the cylinder (7), as follows. (The cylinder is symmetrical, so either end may face up.) Lubricate the piston packings (P). With the piston end facing down, lower the rod into the cylinder. Start the piston into the cylinder as much as possible, then drive the rod and piston the rest of the way into the cylinder with the arbor press.
5. Lubricate the o-ring (27*) and seal (6*). Install the o-ring on the intake seat housing (15). Install the intake seat housing (15), intake ball (16), ball guide (14), and seal (6*) in the intake housing (17). Set the intake housing all the way into the vise.
6. Place the cylinder (7) on the intake housing (17). Tap on the top of the displacement rod (1) with a rubber mallet, to seat the cylinder.
7. Lubricate the throat packings (T). Install the throat packings (T) in the outlet housing (19) in the correct order for your lower, see **Repair Kits**, pages 16-20.

Install the v-packings one at a time with the lips facing down.

 To convert the lower to a different packing material, see pages 16-20.

8. Lubricate the threads of the packing nut (3), and loosely install it in the outlet housing (19).
9. Lubricate the seal (6*) and install it in the bottom of the outlet housing (19). Set the outlet housing on top of the cylinder (7). Apply thread lubricant to the six long cap screws (20). Install the cap screws through the outlet housing (19) and thread them loosely by hand into the intake housing (17). Tighten the cap screws oppositely and evenly, then torque to 244-264 N•m (180-195 ft-lb).
10. Install the bleeder valve plug (35). The plug has two sets of threads. Be sure to screw the plug fully into the valve body (34). Torque the plug to 30-38 N•m (22-28 ft-lb).

 It is not ordinarily necessary to remove the outlet fitting (4) and o-ring (5*). However, if they were replaced because of damage, lubricate the o-ring and place it on the fitting. Screw the fitting into the outlet housing (19). Torque to 156-171 N•m (115-126 ft-lb).

11. Reconnect the lower to the motor as explained in your separate pump assembly manual.

- ⚠1 Torque to 156-171 N•m (115-126 ft-lb).
- ⚠2 Torque to 135-169 N•m (100-125 ft-lb). For 241648, 249991, and 15F298, limit torque to 27-40 N•m (20-30 ft-lb).
- ⚠3 Torque to 459-481 N•m (338-354 ft-lb).
- ⚠4 Torque oppositely and evenly to 244-264 N•m (180-195 ft-lb).
- ⚠5 Apply anti-seize lubricant to threads and mating faces.
- ⚠6 Lubricate.
- ⚠7 Apply thread lubricant.
- ⚠8 Use arbor press to drive into cylinder (7).
- ⚠9 Unscrew plug from valve housing and clean.
- ⚠10 Torque to 30-38 N•m (22-28 ft-lb).
- ⚠11 Used on lowers with stainless steel capscrews only.

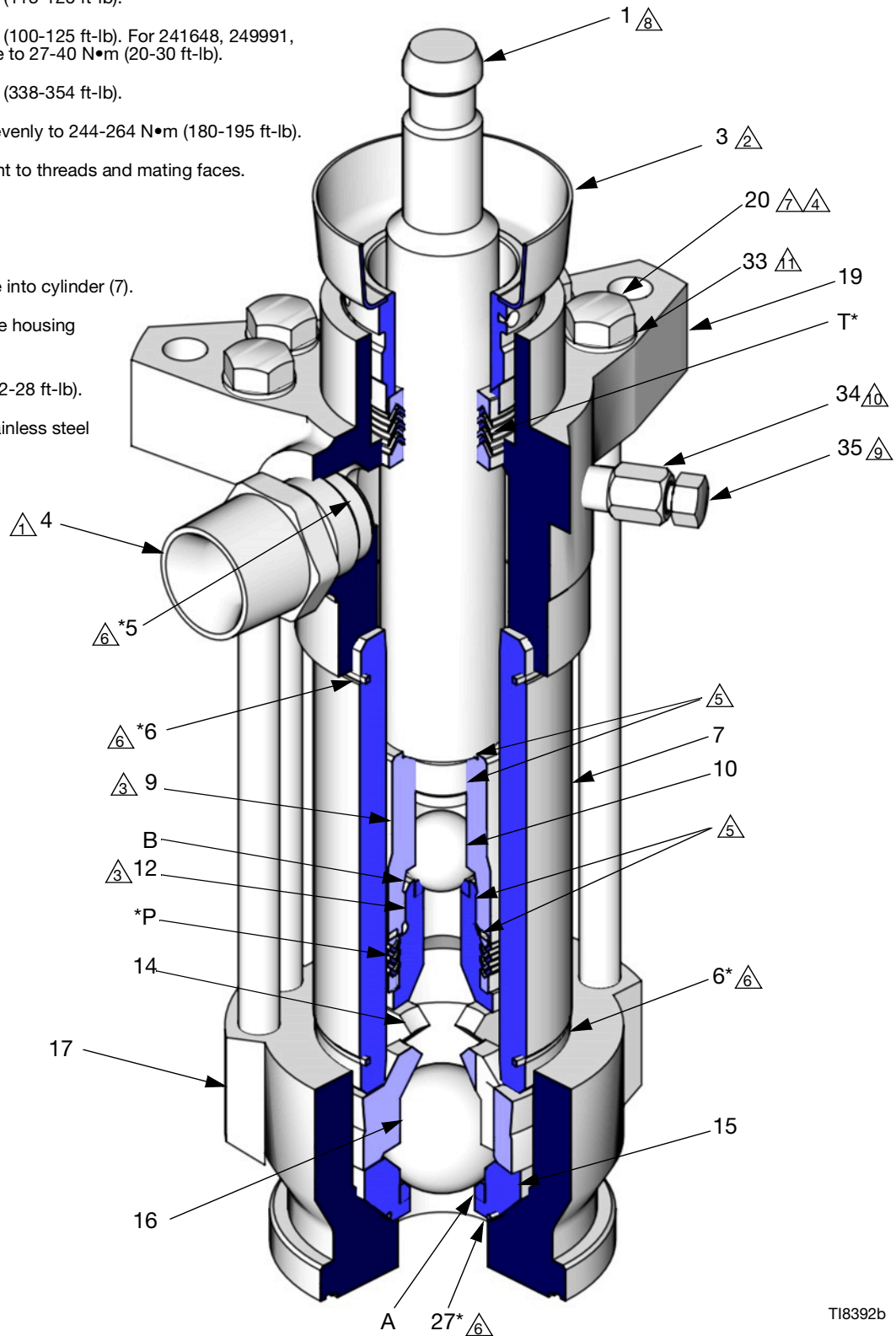

T18392b

FIG. 1. Cutaway View

Parts

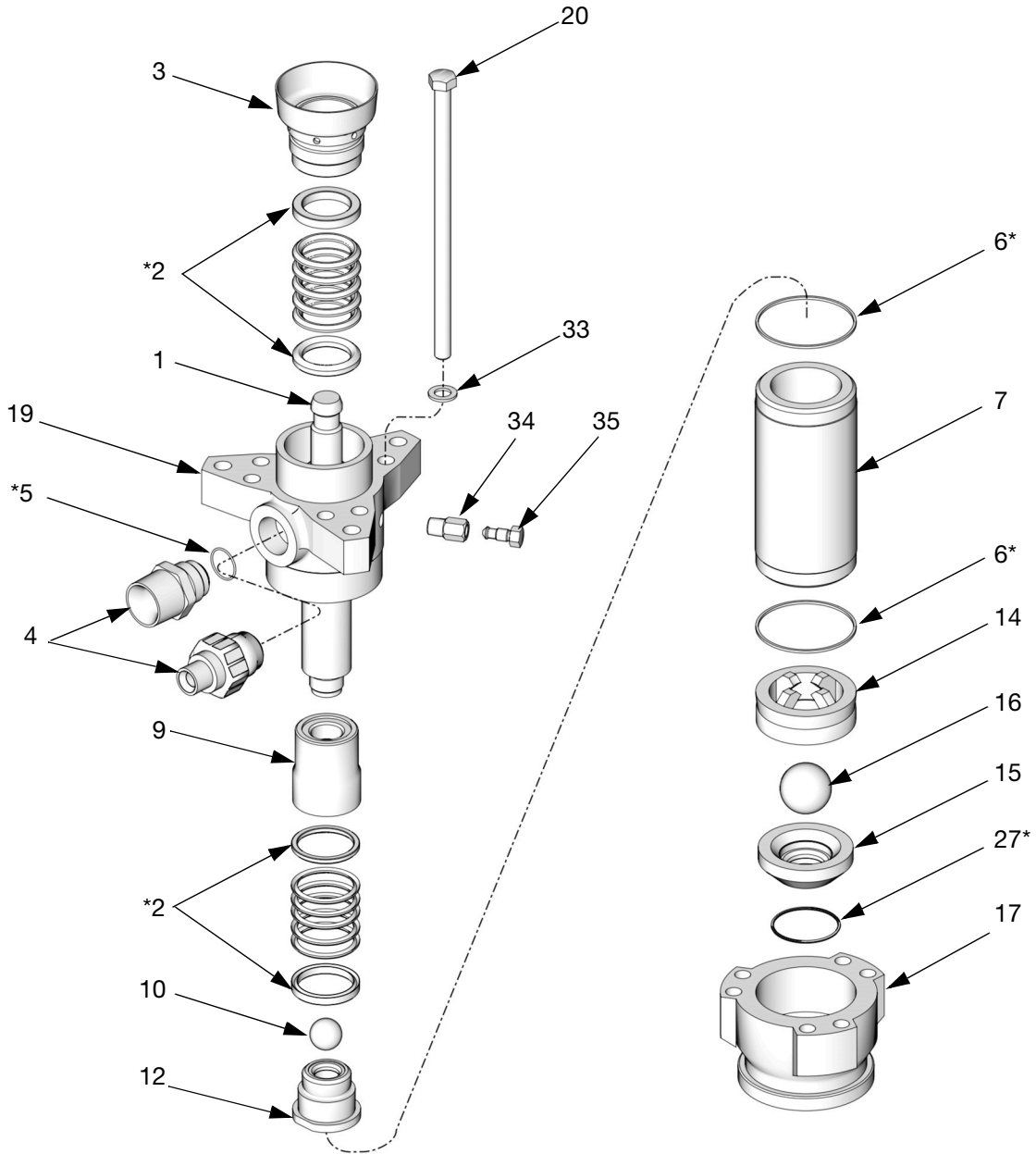

T18340c

Dura-Flo 1800 (430 cc) Lower

 See the parts drawing on page 11. Part numbers vary by lower. To find the part number used in your lower, read down the chart to find the desired ref. no., then read left to right to find the part number for your lower.

Carbon Steel Lower

Ref.	Description	Lower Part No.					Qty
		222796 CST	222988 CST	L430CS CST	24W644	L430CM CST	
1	ROD, displacement; sst	184276	184276	184276	184276	15G852	1
	ROD, displacement; Ultralife						1
	ROD, displacement; MaxLife						1
2*	KIT, repair; includes throat and piston packings, and items 5, 6, and 27; see pages 16-19	222849	222846	222845	222845	253244	1
3	PACKING NUT/WET-CUP	24U017	24U017	24U017	24U017	24U017	1
4	FITTING, outlet; 1-1/2 in. npt(m) x M42 x 20; sst	184279	184279	184279		184279	1
	FITTING, outlet; 3/4 npt(m) x M42 x 20; cs				184470		1
5*	O-RING; PTFE	109213	109213	109213	109213	109213	1
6*	SEAL; acetal	184072	184072	184072	184072	184072	2
7	CYLINDER	184461	184461	184461	184461	15G853	1
9	GUIDE, ball, piston	184283	184283	184283	184283	184283	1
10	BALL, piston; sst; 1.25 in. (31.8 mm)	102973	102973	102973	102973		1
	BALL, piston; carbide; 1.25 in. (31.8 mm)					15C869	1
	BALL, piston; silicone nitride; 1.25 in. (31.8 mm)						1

Ref.	Description	Lower Part No.					Qty
		222796 CST	222988 CST	L430CS CST	24W644	L430CM CST	
12	PISTON; carbide seat	222795	222795	222795	222795	253743	1
14	GUIDE, ball, intake	184406	184406	184406	184406	184406	1
15	SEAT, intake valve; carbide	222794	222794	222794	222794	253742	1
16	BALL, intake; sst; 2 in. (50.8 mm)	102974	102974	102974	102974		1
	BALL, intake; carbide; 2 in. (50.8 mm)					15C868	1
	BALL, intake; silicone nitride; 2 in. (50.8 mm)						1
17	HOUSING, intake	184275	184275	184275	184275	184275	1
19	HOUSING, outlet	222918	222918	222918	222918	222918	1
20	SCREW, cap; 5/8-11 x 12 in. (305 mm); cst	109203	109203	109203	109203	109203	6
	SCREW, cap; 5/8-11 x 12 in. (305 mm); sst						6
27*	O-RING; PTFE	102857	102857	102857	102857	102857	1
33	WASHER; sst					184618	6
34	BODY, valve, bleeder	190126	165702	190126	190126	190126	1
35	PLUG, valve, bleeder	190128	190128	190128	190128	190128	1
	PLUG, pipe						1

* Parts included in Repair Kit (purchase separately). See page 16.

Stainless Steel Lowers

Ref. No.	Description	Lower Part No.										Qty
		222805 SST	241956 SST	687055 SST	246925 SST	C59703 SST	249992 SST	246987 SST	246988 SST	L430SS SST	L430SM SST	
1	ROD, displacement; sst	184276		184276	184276	184276	15G852	184276		184276	15G852	1
	ROD, displacement; Ultralife		687118						687118			1
2*	KIT, repair; includes throat and piston packings, and items 5, 6, and 27; see pages 16-19	222845	222845	17L796	222848	222845	253744	222850	222850	222845	253744	1
3	PACKING NUT/WET-CUP	24U019	24U019	24U019	24U019	24U019	24U019	24U019	24U019	24U019	24U019	1
4	FITTING, outlet; 1-1/2 in. npt(m) x M42 x 20; sst	184387	184387		184387	184387	184387	184387	184387	184387	184387	1
	FITTING, outlet; 3/4 npt(m) x M42 x 20; sst			15B316								1
5*	O-RING; PTFE	109213	109213	109213	109213	109213	109213	109213	109213	109213	109213	1
6*	SEAL; acetal	184072	184072	184072	184072	184072	184072	184072	184072	184072	184072	2
7	CYLINDER	184461	184461	184461	184461	184461	15G853	184461	184461	184461	15G853	1
9	GUIDE, ball, piston	184283	184283	184283	184283	184283	184283	184283	184283	184283	184283	1
10	BALL, piston; sst; 1.25 in. (31.8 mm)	102973		102973						102973		1
	BALL, piston; carbide; 1.25 in. (31.8 mm)		112267		112267	112267						1
	BALL, piston; silicone nitride; 1.25 in. (31.8 mm)						15C869	15C869	15C869		15C869	1
12	PISTON; carbide seat	222795	222795	222795	222795	222795	253743	222795	222795	222795	253743	1
14	GUIDE, ball, intake	184282	184282	184282	184282	184282	184282	184282	184282	184282	184282	1
15	SEAT, intake valve; carbide	222838	222838	222838	222838	222838	253742	222838	222838	222838	253742	1
16	BALL, intake; sst; 2 in. (50.8 mm)	110294		110294						110294		1
	BALL, intake; carbide; 2 in. (50.8 mm)		C59027		C59027	C59027						1
	BALL, intake; silicone nitride; 2 in. (50.8 mm)						15C868	15C868	15C868		15C868	1
17	HOUSING, intake	184390	184390	184390	184390	184390	184390	184390	184390	184390	184390	1
19	HOUSING, outlet	222917	222917	222917	222917	222917	222917	222917	222917	222917	222917	1
20	SCREW, cap; 5/8-11 x 12 in. (305 mm); cst											6
	SCREW, cap; 5/8-11 x 12 in. (305 mm); sst	109470	109470	109470	109470	109470	109470	109470	109470	109470	109470	6
27*	O-RING; PTFE	102857	102857	102857	102857	102857	102857	102857	102857	102857	102857	1
33	WASHER; sst	184618	184618	184618	184618	184618	184618	184618	184618	184618	184618	6
34	BODY, valve, bleeder	184392	190126	184392	190126	184392				184392	184392	1
35	PLUG, valve, bleeder	190293	190293	190293	190293	190293				190293	190293	1
	PLUG, pipe						101748	101748	101748			1

* Parts included in Repair Kit (purchase separately). See page 16.

Dura-Flo 2400 (580 cc) Lowers

 See the parts drawing on page 11. Part numbers vary by lower. To find the part number used in your lower, read down the chart to find the desired ref. no., then read left to right to find the part number for your lower.

Carbon Steel Lowers

Ref No.	Description	Lower Part No.					Qty
		222801 CST	222991 CST	222992 CST	C59798 CST	L580CS CST	
1	ROD, displacement; sst	184002	184002	184002	184002	184002	1
	ROD, displacement; MaxLife						1
2*	KIT, repair; includes throat and piston packings, and items 5, 6, and 27; see pages 16-19	222879	222877	222876	222879	222875	1
3	PACKING NUT/WET-CUP	24U016	24U016	24U016	24U016	24U016	1
4	FITTING, outlet; 1-1/2 in. npt(m) x M42 x 20; sst	184279	184279	184279	184279	184279	1
5*	O-RING; PTFE	109213	109213	109213	109213	109213	1
6*	SEAL; acetal	184072	184072	184072	184072	184072	2
7	CYLINDER	184003	184003	184003	184003	184003	1
9	GUIDE, ball, piston	184297	184297	184297	184297	184297	1
10	BALL, piston; sst; 1.5 in. (38.1 mm)	108001	108001	108001		108001	1
	BALL, piston; carbide; 1.5 in. (38.1 mm)				C59805		1
	BALL, piston; silicone nitride; 1.5 in. (38.1 mm)						1
12	PISTON; carbide seat	222802	222802	222802	222802	222802	1
14	GUIDE, ball, intake	184406	184406	184406	184406	184406	1
15	SEAT, intake valve; carbide	222794	222794	222794	222794	222794	1
16	BALL, intake; sst; 2 in. (50.8 mm)	102974	102974	102974		102974	1
	BALL, intake; carbide; 2 in. (50.8 mm)				C59027		1
	BALL, intake; silicone nitride; 2 in. (50.8 mm)						1
17	HOUSING, intake	184275	184275	184275	184275	184275	1
19	HOUSING, outlet	222922	222922	222922	222922	222922	1
20	SCREW, cap; 5/8-11 x 12 in. (305 mm); cst	109203	109203	109203	109203	109203	6
	SCREW, cap; 5/8-11 x 12 in. (305 mm); sst						6
27*	O-RING; PTFE	102857	102857	102857	102857	102857	1
33	WASHER; sst						6
34	BODY, valve, bleeder	165702	165702	165702	165702	165702	1
35	PLUG, valve, bleeder	190128	190128	190128	190128	190128	1

* Parts included in Repair Kit (purchase separately). See page 16.

Stainless Steel Lowers

Ref No.	Description	Lower Part No.										Qty
		L580SS SST	L580SM SST	222803 SST	222993 SST	222994 SST	236226 SST	236230 SST	241648 SST	15F298 SST	249991 SST	
1	ROD, displacement; sst	184002	15G854	184002	184002	184002	184002	184002	184002	184002	15G854	1
2*	KIT, repair; includes throat and piston packings, and items 5, 6, and 27; see pages 16-19	222875	253745	222875	222879	222876	222875	222877	222880	222881	253745	1
3	PACKING NUT/WET-CUP	24U018	24U018	24U018	24U018	24U018	24U018	24U018	24U018	24U018	24U018	1
4	FITTING, outlet; 1-1/2 in. npt(m) x M42 x 20; sst	184387	184387	184387	184387	184387	184387	184387		184387	184387	1
5*	O-RING; PTFE	109213	109213	109213	109213	109213	109213	109213		109213	109213	1
6*	SEAL; acetal	184072	184072	184072	184072	184072	184072	184072	184072	184072	184072	2
7	CYLINDER	184003	15G855	184003	184003	184003	184003	184003	184003	184003	15G855	1
9	GUIDE, ball, piston	184297	184297	184297	184297	184297	184297	184297	184297	184297	184297	1
10	BALL, piston; sst; 1.5 in. (38.1 mm)	109220		109220	109220	109220	109220	109220	109220			1
	BALL, piston; carbide; 1.5 in. (38.1 mm)											1
	BALL, piston; silicone nitride; 1.5 in. (38.1 mm)		119669							119669	119669	1
12	PISTON; carbide seat	222802	253741	222802	222802	222802	222802	222802	222802	222802	253741	1
14	GUIDE, ball, intake	184282	184282	184282	184282	184282	184282	184282	184282	184282	184282	1
15	SEAT, intake valve; carbide	222838	253742	222838	222838	222838	222838	222838	222838	222838	253742	1
16	BALL, intake; sst; 2 in. (50.8 mm)	110294		110294	110294	110294	110294	110294	110294			1
	BALL, intake; carbide; 2 in. (50.8 mm)											1
	BALL, intake; silicone nitride; 2 in. (50.8 mm)		15C868							15C868	15C868	1
17	HOUSING, intake	184390	184390	184390	184390	184390	184390	184390	184390	184390	184390	1
19	HOUSING, outlet	222921	222921	222921	222921	222921	222921	222921	222921	222921	222921	1
20	SCREW, cap; 5/8-11 x 12 in. (305 mm); cst				109203		109203	109203				6
	SCREW, cap; 5/8-11 x 12 in. (305 mm); sst	109470	109470	109470		109470			109470	109470	109470	6
27*	O-RING; PTFE	102857	102857	102857	102857	102857	102857	102857	102857	102857	102857	1
33	WASHER; sst	184618	184618	184618		184618			184618	184618	184618	6
34	BODY, valve, bleeder	184392	184392	184392	184392	184392	184392	184392	184392			1
35	PLUG, valve, bleeder	190293	190293	190293	190293	190293	190293	190293	190293	101748	101748	1

* Parts included in Repair Kit (purchase separately). See page 16.

Repair Kits

UHMWPE and PTFE Packings

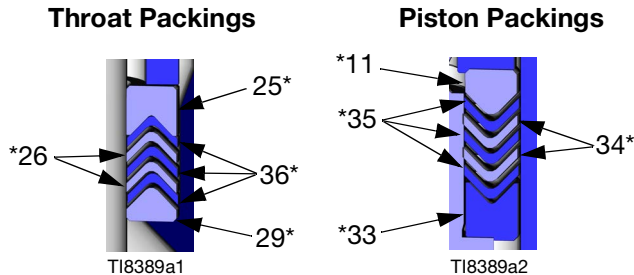

222845 Repair Kit, for Dura-Flo 1800 (standard for 222805, 241956, L430CS, L430SS)

Ref.	Part No.	Description	Qty
11*	184232	GLAND, male, piston; stainless steel	1
25*	184181	GLAND, female, throat; stainless steel	1
26*	109311	V-PACKING, throat; PTFE	2
29*	184231	GLAND, male, throat; stainless steel	1
33*	184182	GLAND, female, piston; stainless steel	1
34*	109312	V-PACKING, piston; PTFE	2
35*	109262	V-PACKING, piston; UHMWPE	3
36*	109261	V-PACKING, throat; UHMWPE	3

222875 Repair Kit, for Dura-Flo 2400 (standard for 222803, 236226, L580CS, L580SS)

Ref.	Part No.	Description	Qty
11*	184236	GLAND, male, piston; stainless steel	1
25*	184185	GLAND, female, throat; stainless steel	1
26*	109315	V-PACKING, throat; PTFE	2
29*	184235	GLAND, male, throat; stainless steel	1
33*	184186	GLAND, female, piston; stainless steel	1
34*	109316	V-PACKING, piston; PTFE	2
35*	109266	V-PACKING, piston; UHMWPE	3
36*	109265	V-PACKING, throat; UHMWPE	3

17L796 Repair Kit, for Part No. 687055 Dura-Flo 1800

Ref.	Part No.	Description	Qty
11	184232	GLAND, male, piston; stainless steel	1
25	184181	GLAND, female, throat; stainless steel	1
26	687056	V-PACKING, throat; graphite/PTFE	2
29	184231	GLAND, male, throat; stainless steel	1
33	184182	GLAND, female, piston; stainless steel	1
34	687057	V-PACKING, piston; graphite/PTFE	2
35	109262	V-PACKING, piston; UHMWPE	3
36	109261	V-PACKING, throat; UHMWPE	3

222880 Repair Kit, for Dura-Flo 2400 (standard for 241648)

 Carbon-filled PTFE for use with water up to 60°C (140°F).

Limit packing nut torque to 27-40 N•m (20-30 ft-lb).

Ref.	Part No.	Description	Qty
11*	184236	GLAND, male, piston; stainless steel	1
25*	184185	GLAND, female, throat; stainless steel	1
26*	109317	V-PACKING, throat; carbon-filled PTFE	2
29*	184235	GLAND, male, throat; stainless steel	1
33*	184186	GLAND, female, piston; stainless steel	1
34*	109318	V-PACKING, piston; carbon-filled PTFE	2
35*	109266	V-PACKING, piston; UHMWPE	3
36*	109265	V-PACKING, throat; UHMWPE	3

PTFE and Leather Packings

Throat Packings

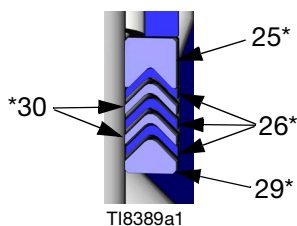

Piston Packings

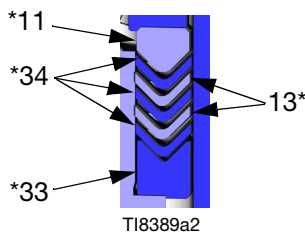

222849 Repair Kit, for Dura-Flo 1800 (standard for 222796)

Ref.	Part No.	Description	Qty
11*	184232	GLAND, male, piston; stainless steel	1
13*	184312	V-PACKING, piston; leather	2
25*	184181	GLAND, female, throat; stainless steel	1
26*	109311	V-PACKING, throat; PTFE	3
29*	184231	GLAND, male, throat; stainless steel	1
30*	184311	V-PACKING, throat; leather	2
33*	184182	GLAND, female, piston; stainless steel	1
34*	109312	V-PACKING, piston; PTFE	3

222879 Repair Kit, for Dura-Flo 2400 (standard for 222801, 222993)

Ref.	Part No.	Description	Qty
11*	184236	GLAND, male, piston; stainless steel	1
13*	184316	V-PACKING, piston; leather	2
25*	184185	GLAND, female, throat; stainless steel	1
26*	109315	V-PACKING, throat; PTFE	3
29*	184235	GLAND, male, throat; stainless steel	1
30*	184315	V-PACKING, throat; leather	2
33*	184186	GLAND, female, piston; stainless steel	1
34*	109316	V-PACKING, piston; PTFE	3

222847 Leather/PTFE Backup Conversion Kit, for Dura-Flo 1800

Ref.	Part No.	Description	Qty
11*	184232	GLAND, male, piston; stainless steel	1
13*	184312	V-PACKING, piston; leather	4
25*	184181	GLAND, female, throat; stainless steel	1
26*	109311	V-PACKING, throat; PTFE	1
29*	184231	GLAND, male, throat; stainless steel	1
30*	184311	V-PACKING, throat; leather	4
33*	184182	GLAND, female, piston; stainless steel	1
34*	109312	V-PACKING, piston; PTFE	1

222877 Leather/PTFE Repair Kit, for Dura-Flo 2400 (standard for 222991, 236230)

Ref.	Part No.	Description	Qty
11*	184236	GLAND, male, piston; stainless steel	1
13*	184316	V-PACKING, piston; leather	4
25*	184185	GLAND, female, throat; stainless steel	1
26*	109315	V-PACKING, throat; PTFE	1
29*	184235	GLAND, male, throat; stainless steel	1
30*	184315	V-PACKING, throat; leather	4
33*	184186	GLAND, female, piston; stainless steel	1
34*	109316	V-PACKING, piston; PTFE	1

PTFE Packings

Throat Packings

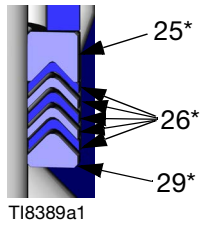

Piston Packings

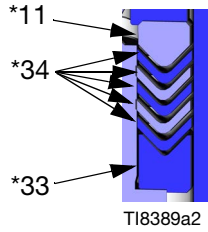

222846 Repair Kit, for Dura-Flo 1800 (standard for 222998)

Ref.	Part No.	Description	Qty
11*	184232	GLAND, male, piston; stainless steel	1
25*	184181	GLAND, female, throat; stainless steel	1
26*	109311	V-PACKING, throat; PTFE	5
29*	184231	GLAND, male, throat; stainless steel	1
33*	184182	GLAND, female, piston; stainless steel	1
34*	109312	V-PACKING, piston; PTFE	5

222876 Repair Kit, for Dura-Flo 2400 (standard for 222992, 222994)

Ref.	Part No.	Description	Qty
11*	184236	GLAND, male, piston; stainless steel	1
25*	184185	GLAND, female, throat; stainless steel	1
26*	109315	V-PACKING, throat; PTFE	5
29*	184235	GLAND, male, throat; stainless steel	1
33*	184186	GLAND, female, piston; stainless steel	1
34*	109316	V-PACKING, piston; PTFE	5

UHMWPE and Leather Packings

Throat Packings

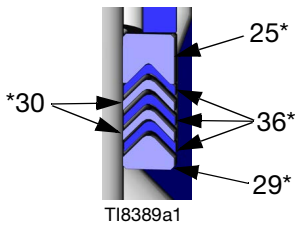

Piston Packings

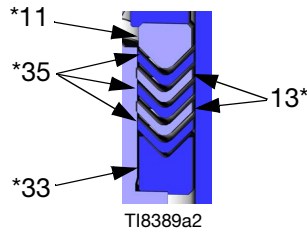

222848 Repair Kit, for Dura-Flo 1800 (standard for 246925, 24W644)

Ref.	Part No.	Description	Qty
11*	184232	GLAND, male, piston; stainless steel	1
13*	184312	V-PACKING, piston; leather	2
25*	184181	GLAND, female, throat; stainless steel	1
29*	184231	GLAND, male, throat; stainless steel	1
30*	184311	V-PACKING, throat; leather	2
33*	184182	GLAND, female, piston; stainless steel	1
35*	109262	V-PACKING, piston; UHMWPE	3
36*	109261	V-PACKING, throat; UHMWPE	3

253744 Repair Kit, for Dura-Flo 1800 (standard for 249992, L430SM, L430CM)

Ref.	Part No.	Description	Qty
11	184232	GLAND, male, piston; stainless steel	1
13	120533	V-PACKING, piston; UHMWPE	2
25	184181	GLAND, female, throat; stainless steel	1
29	184231	GLAND, male, throat; stainless steel	1
30	184311	V-PACKING, throat; leather	4
33	184182	GLAND, female, piston; stainless steel	1
35	109262	V-PACKING, piston; UHMWPE	3
36	109261	V-PACKING, throat; UHMWPE	3

222878 Conversion Kit, for Dura-Flo 2400

Ref.	Part No.	Description	Qty
11*	184236	GLAND, male, piston; stainless steel	1
13*	184316	V-PACKING, piston; leather	2
25*	184185	GLAND, female, throat; stainless steel	1
29*	184235	GLAND, male, throat; stainless steel	1
30*	184315	V-PACKING, throat; leather	2
33*	184186	GLAND, female, piston; stainless steel	1
35*	109266	V-PACKING, piston; UHMWPE	3
36*	109265	V-PACKING, throat; UHMWPE	3

222850 Repair Kit, for Dura-Flo 1800 (standard for 246987, 246988)

Ref.	Part No.	Description	Qty
11*	184232	GLAND, male, piston; stainless steel	1
13*	184312	V-PACKING, piston; leather	2
25*	184181	GLAND, female, throat; stainless steel	1
29*	184231	GLAND, male, throat; stainless steel	1
30*	184311	V-PACKING, throat; leather	4
33*	184182	GLAND, female, piston; stainless steel	1
35*	109262	V-PACKING, piston; UHMWPE	3
36*	109261	V-PACKING, throat; UHMWPE	3

222881 Repair Kit, for Dura-Flo 2400 (standard for 15F298)

 Limit packing nut torque to 27-40 N•m (20-30 ft-lb).

Ref.	Part No.	Description	Qty
11*	184236	GLAND, male, piston; stainless steel	1
13*	184316	V-PACKING, piston; leather	2
25*	184185	GLAND, female, throat; stainless steel	1
29*	184235	GLAND, male, throat; stainless steel	1
30*	184315	V-PACKING, throat; leather	4
33*	184186	GLAND, female, piston; stainless steel	1
35*	109266	V-PACKING, piston; UHMWPE	3
36*	109265	V-PACKING, throat; UHMWPE	3

**253745 Repair Kit, for Dura-Flo 2400
(standard for 249991, L580SM)**

 Limit packing nut torque to 27-40 N•m (20-30 ft-lb).

Ref.	Part No.	Description	Qty
11*	184236	GLAND, male, piston; stainless steel	1
13*	120532	V-PACKING, piston; UHMWPE	2
25*	184185	GLAND, female, throat; stainless steel	1
29*	184235	GLAND, male, throat; stainless steel	1
30*	184315	V-PACKING, throat; leather	4
33*	184186	GLAND, female, piston; stainless steel	1
35*	109266	V-PACKING, piston; UHMWPE	3
36*	109265	V-PACKING, throat; UHMWPE	3

California Proposition 65

CALIFORNIA RESIDENTS

 **WARNING:** Cancer and reproductive harm – www.P65warnings.ca.gov.

Graco Standard Warranty

Graco warrants all equipment referenced in this document which is manufactured by Graco and bearing its name to be free from defects in material and workmanship on the date of sale to the original purchaser for use. With the exception of any special, extended, or limited warranty published by Graco, Graco will, for a period of twelve months from the date of sale, repair or replace any part of the equipment determined by Graco to be defective. This warranty applies only when the equipment is installed, operated and maintained in accordance with Graco's written recommendations.

This warranty does not cover, and Graco shall not be liable for general wear and tear, or any malfunction, damage or wear caused by faulty installation, misapplication, abrasion, corrosion, inadequate or improper maintenance, negligence, accident, tampering, or substitution of non-Graco component parts. Nor shall Graco be liable for malfunction, damage or wear caused by the incompatibility of Graco equipment with structures, accessories, equipment or materials not supplied by Graco, or the improper design, manufacture, installation, operation or maintenance of structures, accessories, equipment or materials not supplied by Graco.

This warranty is conditioned upon the prepaid return of the equipment claimed to be defective to an authorized Graco distributor for verification of the claimed defect. If the claimed defect is verified, Graco will repair or replace free of charge any defective parts. The equipment will be returned to the original purchaser transportation prepaid. If inspection of the equipment does not disclose any defect in material or workmanship, repairs will be made at a reasonable charge, which charges may include the costs of parts, labor, and transportation.

THIS WARRANTY IS EXCLUSIVE, AND IS IN LIEU OF ANY OTHER WARRANTIES, EXPRESS OR IMPLIED, INCLUDING BUT NOT LIMITED TO WARRANTY OF MERCHANTABILITY OR WARRANTY OF FITNESS FOR A PARTICULAR PURPOSE.

Graco's sole obligation and buyer's sole remedy for any breach of warranty shall be as set forth above. The buyer agrees that no other remedy (including, but not limited to, incidental or consequential damages for lost profits, lost sales, injury to person or property, or any other incidental or consequential loss) shall be available. Any action for breach of warranty must be brought within two (2) years of the date of sale.

GRACO MAKES NO WARRANTY, AND DISCLAIMS ALL IMPLIED WARRANTIES OF MERCHANTABILITY AND FITNESS FOR A PARTICULAR PURPOSE, IN CONNECTION WITH ACCESSORIES, EQUIPMENT, MATERIALS OR COMPONENTS SOLD BUT NOT MANUFACTURED BY GRACO. These items sold, but not manufactured by Graco (such as electric motors, switches, hose, etc.), are subject to the warranty, if any, of their manufacturer. Graco will provide purchaser with reasonable assistance in making any claim for breach of these warranties.

In no event will Graco be liable for indirect, incidental, special or consequential damages resulting from Graco supplying equipment hereunder, or the furnishing, performance, or use of any products or other goods sold hereto, whether due to a breach of contract, breach of warranty, the negligence of Graco, or otherwise.

FOR GRACO CANADA CUSTOMERS

The Parties acknowledge that they have required that the present document, as well as all documents, notices and legal proceedings entered into, given or instituted pursuant hereto or relating directly or indirectly hereto, be drawn up in English. Les parties reconnaissent avoir convenu que la rédaction du présente document sera en Anglais, ainsi que tous documents, avis et procédures judiciaires exécutés, donnés ou intentés, à la suite de ou en rapport, directement ou indirectement, avec les procédures concernées.

Graco Information

For the latest information about Graco products, visit www.graco.com.

For patent information, see www.graco.com/patents.

TO PLACE AN ORDER, contact your Graco distributor or call to identify the nearest distributor.

Phone: 612-623-6921 or Toll Free: 1-800-328-0211 Fax: 612-378-3505

All written and visual data contained in this document reflects the latest product information available at the time of publication. Graco reserves the right to make changes at any time without notice.

Original instructions. This manual contains English. MM 311825

Graco Headquarters: Minneapolis

International Offices: Belgium, China, Japan, Korea

GRACO INC. AND SUBSIDIARIES • P.O. BOX 1441 • MINNEAPOLIS MN 55440-1441 • USA

Copyright 2006, Graco Inc. All Graco manufacturing locations are registered to ISO 9001.

www.graco.com

Revision P, October 2021