

# APX Electric Texture Sprayers

3A4442F

EN

*For portable airless spraying of water-based materials only.*

*For professional use only.*

*Not approved for use in explosive atmosphere or hazardous locations.*

**Models: APX 5200, APX 6200 and APX 8200**

See page 2 for model information, including maximum working pressure and approvals.



## Important Safety Instructions

Read all warnings and instructions in this manual and related manuals.  
Be familiar with the controls and the proper usage of the equipment.  
Save these instructions.

### Related Manuals

Gun – 309495 (APX 6200 & 8200)      Pump – 332922

Gun – 308491 (APX 5200)

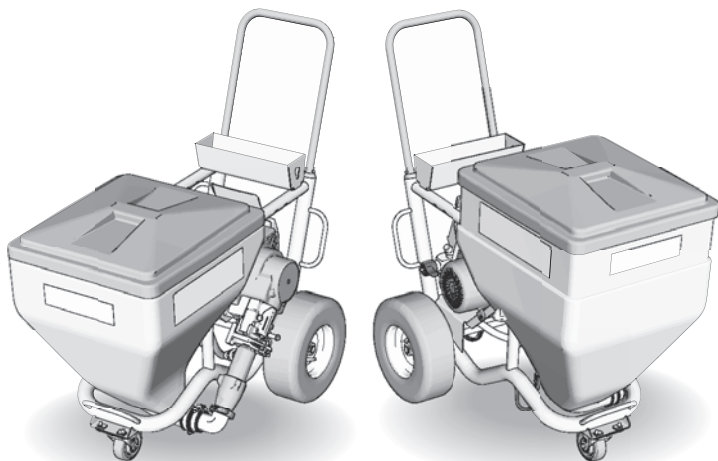



ti29970a



## Contents

<b>Warnings</b> .....	<b>3</b>
<b>Component Identification</b> .....	<b>7</b>
<b>Preparation</b> .....	<b>8</b>
Mixing Material .....	8
Pressure Relief Procedure .....	10
<b>Setup</b> .....	<b>11</b>
<b>Start Up</b> .....	<b>13</b>
<b>Operation</b> .....	<b>17</b>
Spray Tip Installation .....	17
Clear Tip Clog .....	18
<b>Troubleshooting</b> .....	<b>24</b>
<b>APX Cart Parts</b> .....	<b>38</b>
<b>APX Pump and Motor Parts</b> .....	<b>40</b>
<b>APX Control and Manifold Parts</b> .....	<b>42</b>
<b>APX VIBRA-FLO Shaker Parts</b> .....	<b>44</b>
<b>APX VIBRA-FLO Shaker Control Parts</b> .....	<b>45</b>
<b>Wiring Diagrams</b> .....	<b>46</b>
<b>Wiring Diagrams</b> .....	<b>47</b>
<b>Technical Specifications</b> .....	<b>48</b>
<b>Graco Standard Warranty</b> .....	<b>51</b>

## Models

	VAC	Model	
	110 U.K.	APX 5200	17S762
		APX 5200 with bag roller	17S769
	230 Europe Multi	APX 6200	17N343
		APX 8200	17N350
		APX 6200 with bag roller	17N344
		APX 8200 with bag roller	17N351
	230 CEE 7/7	APX 6200	17N345
		APX 6200 with bag roller	17N346
		APX 8200	17N352
	230 LA Asia/ANZ	APX 8200 with bag roller	17N353
		APX 6200	17N347
		APX 6200 with bag roller	17N348
		APX 8200	17N354
		APX 8200 with bag roller	17N355

3000 psi (20.7MPa, 207bar) Maximum Working Pressure

# Warnings

The following warnings are for the setup, use, grounding, maintenance, and repair of this equipment. The exclamation point symbol alerts you to a general warning and the hazard symbols refer to procedure-specific risks. When these symbols appear in the body of this manual or on warning labels, refer back to these Warnings. Product-specific hazard symbols and warnings not covered in this section may appear throughout the body of this manual where applicable.

## WARNING



### GROUNDING

This product must be grounded. In the event of an electrical short circuit, grounding reduces the risk of electric shock by providing an escape wire for the electric current. This product is equipped with a cord having a grounding wire with an appropriate grounding plug. The plug must be plugged into an outlet that is properly installed and grounded in accordance with all local codes and ordinances.

- Improper installation of the grounding plug is able to result in a risk of electric shock.
- When repair or replacement of the cord or plug is required, do not connect the grounding wire to either flat blade terminal.
- The wire with insulation having an outer surface that is green with or without yellow stripes is the grounding wire.
- Check with a qualified electrician or serviceman when the grounding instructions are not completely understood, or when in doubt as to whether the product is properly grounded.
- Do not modify the plug provided; if it does not fit the outlet, have the proper outlet installed by a qualified electrician.
- This product is for use on a nominal 110V or 230V circuit and has a grounding plug similar to the plugs illustrated below.

110V UK

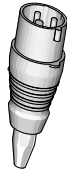

230V

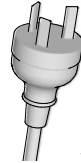
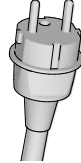

ti24583a

- Only connect the product to an outlet having the same configuration as the plug.
- Do not use an adapter with this product.

### Extension Cords:

- Use only a 3-wire extension cord that has a grounding plug and a grounding receptacle that accepts the plug on the product.
- Make sure your extension cord is not damaged. If an extension cord is necessary use 12 AWG (2.5mm<sup>2</sup>) minimum to carry the current that the product draws.
- An undersized cord results in a drop in line voltage and loss of power and overheating.

## **WARNING**



### **FIRE AND EXPLOSION HAZARD**

Flammable fumes, such as solvent and paint fumes, in work area can ignite or explode. To help prevent fire and explosion:



- Do not spray or clean with flammable materials. Use water-based materials only.
- Use equipment only in well ventilated area.
- Sprayer generates sparks. When flammable liquids are used near the sprayer, keep sprayer at least 20 feet (6.1 meters) away from explosive vapors.
- Eliminate all ignition sources.
- Keep work area free of debris, including solvent, rags and gasoline.
- Ground all equipment in the work area. See **Grounding** instructions.
- Keep a working fire extinguisher in the work area.



### **SKIN INJECTION HAZARD**

High-pressure spray is able to inject toxins into the body and cause serious bodily injury. In the event that injection occurs, **get immediate surgical treatment.**



- Do not aim the gun at, or spray any person or animal.
- Keep hands and other body parts away from the discharge. For example, do not try to stop leaks with any part of the body.
- Always use the nozzle tip guard. Do not spray without nozzle tip guard in place.
- Use Graco nozzle tips.
- Use caution when cleaning and changing nozzle tips. In the case where the nozzle tip clogs while spraying, follow the **Pressure Relief Procedure** for turning off the unit and relieving the pressure before removing the nozzle tip to clean.
- Equipment maintains pressure after power is shut off. Do not leave the equipment energized or under pressure while unattended. Follow the **Pressure Relief Procedure** when the equipment is unattended or not in use, and before servicing, cleaning, or removing parts.
- Check hoses and parts for signs of damage. Replace any damaged hoses or parts.
- This system is capable of producing 3000 psi (207 bar, 20.7 MPa). Use Graco replacement parts or accessories that are rated a minimum of 3000 psi (207 bar, 20.7 MPa).
- Always engage the trigger lock when not spraying. Verify the trigger lock is functioning properly.
- Verify that all connections are secure before operating the unit.
- Know how to stop the unit and bleed pressure quickly. Be thoroughly familiar with the controls.



## **WARNING**



### **EQUIPMENT MISUSE HAZARD**

Misuse can cause death or serious injury.

- Always wear appropriate gloves, eye protection, and a respirator or mask when painting.
- Do not operate or spray near children. Keep children away from equipment at all times.
- Do not overreach or stand on an unstable support. Keep effective footing and balance at all times.
- Stay alert and watch what you are doing.
- Do not operate the unit when fatigued or under the influence of drugs or alcohol.
- Do not kink or over-bend the material or air hose.
- Do not expose the hose to temperatures or to pressures in excess of those specified by Graco.
- Do not use the hose as a strength member to pull or lift the equipment.
- Do not alter or modify equipment. Alterations or modifications may void agency approvals and create safety hazards.
- Make sure all equipment is rated and approved for the environment in which you are using it.



### **ELECTRIC SHOCK HAZARD**

This equipment must be grounded. Improper grounding, setup, or usage of the system can cause electric shock.

- Turn off and disconnect power cord before servicing equipment.
- Connect only to grounded electrical outlets.
- Use only 3-wire extension cords.
- Ensure ground prongs are intact on power and extension cords.
- Do not expose to rain. Store indoors.
- Wait five minutes after disconnecting power cord before servicing.



### **PRESSURIZED ALUMINUM PARTS HAZARD**

Use of fluids that are incompatible with aluminum in pressurized equipment can cause serious chemical reaction and equipment rupture. Failure to follow this warning can result in death, serious injury, or property damage.

- Do not use 1,1,1-trichloroethane, methylene chloride, other halogenated hydrocarbon solvents or fluids containing such solvents.
- Do not use chlorine bleach.
- Many other fluids may contain chemicals that can react with aluminum. Contact your material supplier for compatibility.

# Warnings

## **WARNING**



### **MOVING PARTS HAZARD**

Moving parts can pinch, cut, or amputate fingers and other body parts.

- Keep clear of moving parts.
- Do not operate equipment with protective guards or covers removed.
- Pressurized equipment can start without warning. Before checking, moving, or servicing equipment, follow the **Pressure Relief Procedure** and disconnect all power sources.



### **PLASTIC PARTS CLEANING SOLVENT HAZARD**

Many solvents can degrade plastic parts and cause them to fail, which could cause serious injury or property damage.

- Use only compatible water-based solvents to clean plastic structural or pressure-containing parts.
- See **Technical Specifications** in this and all other equipment instruction manuals. Read fluid and solvent manufacturer's Safety Data Sheet (SDS) and recommendations.



### **PERSONAL PROTECTIVE EQUIPMENT**

Wear appropriate protective equipment when in the work area to help prevent serious injury, including eye injury, hearing loss, inhalation of toxic fumes, and burns. This protective equipment includes but is not limited to:

- Protective eyewear, and hearing protection.
- Respirators, protective clothing, and gloves as recommended by the fluid and solvent manufacturer.

## Component Identification

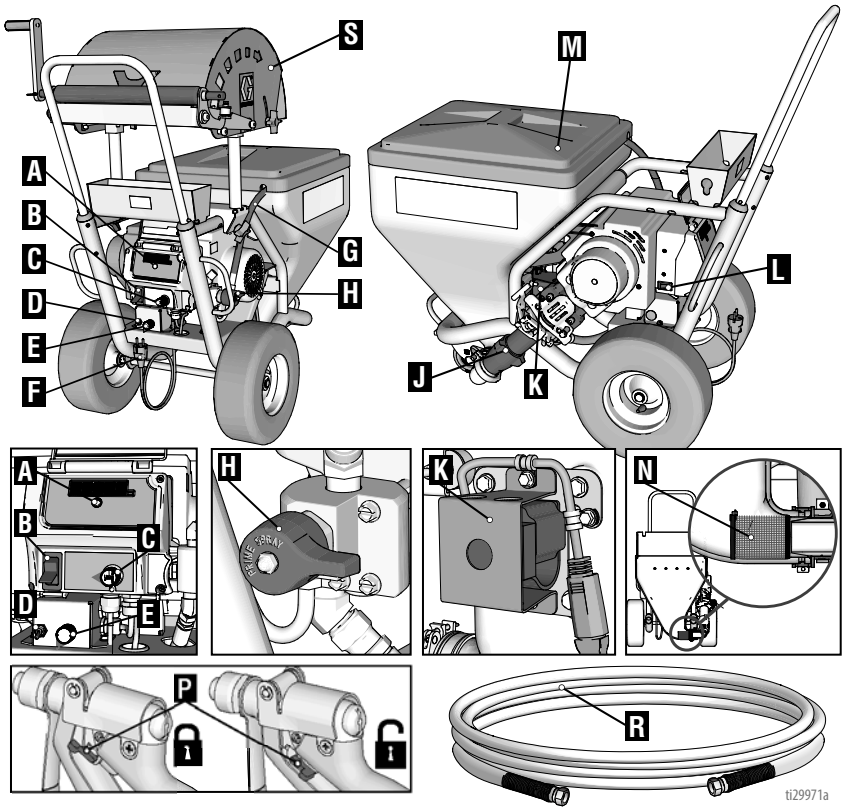

A	Smart Control
B	ON/OFF Switch
C	Pressure Control
D	VIBRA-FLO™ ON/OFF Switch (6200/8200 models)
E	VIBRA-FLO Control (6200/8200 models)
F	Power Cord
G	Drain Tube
H	Prime / Spray Valve
J	Pump

K	VIBRA-FLO Hopper Shaker (6200/8200 models)
L	Amp Switch
M	Hopper with cover
N	Hopper Strainer
P	Trigger Lock
R	Hose
S	Bag Roller (Optional)
	Model/Serial Tag (Located on bottom)

# Preparation

## Preparation

### Grounding



The equipment must be grounded to reduce the risk of static sparking and electric shock. An electric or static spark can cause fumes to ignite or explode. An improper ground can cause electric shock. A good ground provides an escape wire for the electric current.

This sprayer includes a ground wire with an appropriate ground contact. The plug must be plugged into an outlet that is properly installed and grounded in accordance with all local codes and ordinances.

Do not modify the plug provided; if it does not fit the outlet, have the proper outlet installed by a qualified electrician.

### Power Switch

Select 15A or 20A depending on your circuit rating. 110V units require 100-120 VAC, 50/60 Hz, 15 – 20A, 1 phase

Select 10A or 16A depending on your circuit rating. 230V units require 220-240 VAC, 50/60 Hz, 10 – 16A, 1 phase

### Extension Cords

Use an extension cord with an undamaged ground contact. If an extension cord is necessary, use a 3-wire, 12 AWG (2.5 mm<sup>2</sup>) minimum.

**NOTE:** Lighter gauge or longer extension cords may reduce sprayer performance.

### Generator Requirements

5000 W (5 kW) minimum.

## ProGuard

The ProGuard protects the sprayer against high and low voltage spikes. If the sprayer is plugged into a power source that goes too low or too high the sprayer stops operating.

## VIBRA-FLO Shaker (6200/8200 models)

The hopper shaker vibrates the hopper which assists in moving the material down to the pump inlet at the bottom of the hopper.

## Bag Roller (Optional)

Bags of material can be difficult to empty. A bag roller provides a quick and easy way to empty material bags directly into the hopper.

## Mixing Material



**NOTE:** Correct material mixture is essential. The pump and spray gun will not operate if the mixture is too thick. Use water-based materials only.

1. Mix the material and water in a separate container.

### Dry Mix

Carefully mix texture material and water according to manufacturer instructions on bag.



## Premix

Slowly add water to a 5 gallon (18.9 liter) bucket of premix.

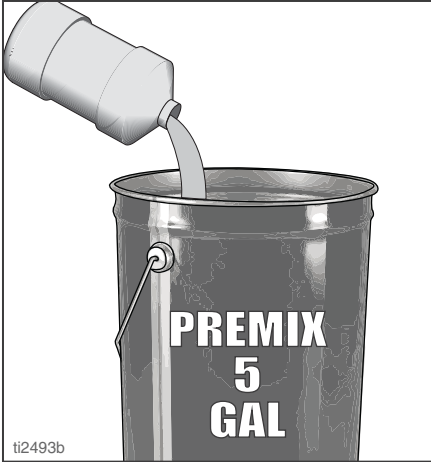

2. Agitate to mix with mixing paddle, to a smooth, lump-free consistency.



3. Make certain all dry powder clumps are mixed thoroughly before pouring mixture into the sprayer hopper.

### NOTICE

Failure to make certain that all dry powder is thoroughly mixed may cause tip or pump clogging.

# Preparation

## Pressure Relief Procedure



Follow the Pressure Relief Procedure whenever you see this symbol.



This equipment stays pressurized until pressure is manually relieved. To help prevent serious injury from pressurized fluid, such as skin injection, splashed fluid and moving parts, follow the **Pressure Relief Procedure** whenever sprayer is stopped and before sprayer is cleaned or checked, and before equipment is serviced.

1. Turn ON/OFF switch to the **OFF** position. Wait 7 seconds for power to dissipate.

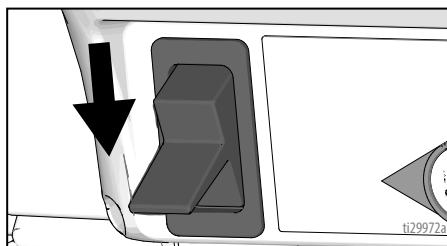

2. Engage trigger lock. Always engage the trigger lock when sprayer is stopped to prevent the gun from being triggered accidentally by hand or if dropped or bumped.

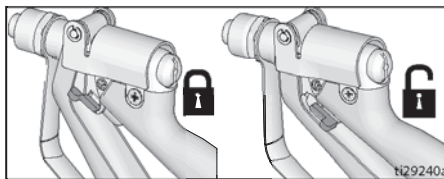

3. Turn pressure control to lowest setting. Disengage the trigger lock.
4. Trigger the gun to relieve pressure.
5. Engage trigger lock.
6. Put drain tube in a pail. Turn prime valve down. Leave prime valve in the down (drain) position until you are ready to spray again.
7. If you suspect the spray tip or hose is clogged or that pressure has not been fully relieved:
  - a. **VERY SLOWLY** loosen the tip guard retaining nut or the hose end coupling to relieve pressure gradually.
  - b. Loosen the nut or coupling completely.
  - c. Clear hose or tip obstruction.

# Setup

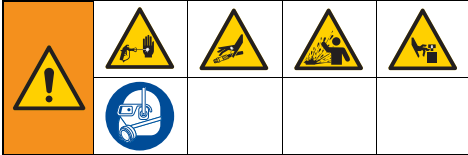

When unpacking sprayer for the first time or after long term storage perform setup procedure. When first setup is performed remove shipping plug from fluid outlet.

1. Connect Graco airless hose to fluid outlet. Use wrenches to tighten securely.
2. Connect whip hose (if applicable) and gun to other end of hose. Apply thread sealant and tighten securely.

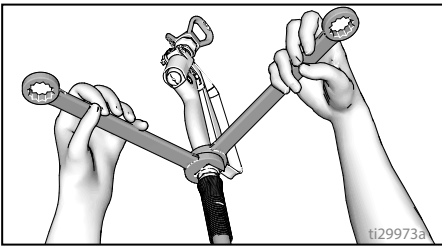

3. Engage trigger lock.

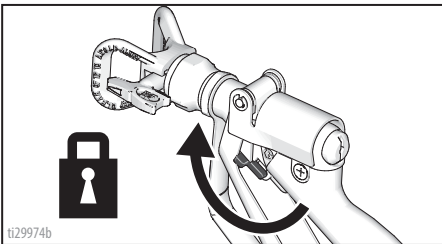

4. Remove tip guard.

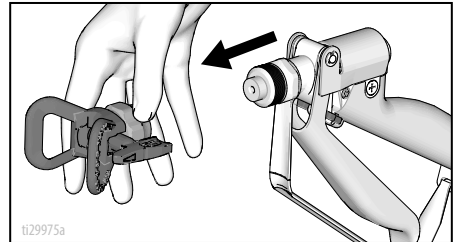

5. A hopper strainer is used to prevent debris from entering the pump.
6. Fill throat packing nut with Graco TSL to prevent premature packing wear. Do this each time you spray.

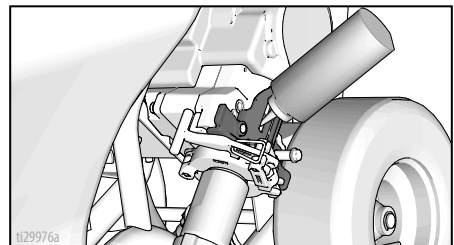

7. Turn ON/OFF switch to the **OFF** position.

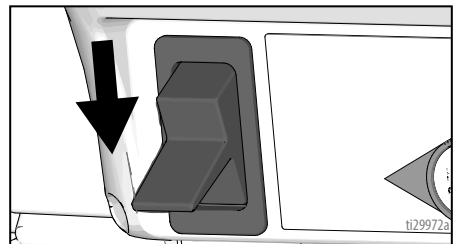

8. Plug power supply cord into a properly grounded electrical outlet.

# Setup

- Turn prime valve down to DRAIN position.

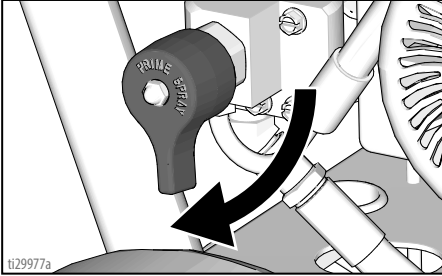

- Add flushing fluid to the hopper.

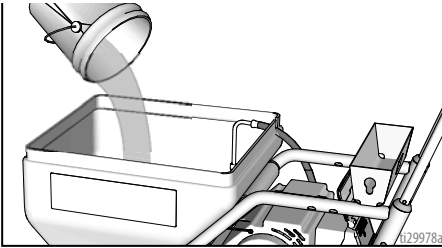

**NOTE:** New sprayers are shipped with storage fluid that must be flushed out prior to using the sprayer.

Check flushing fluid for compatibility with material that is to be sprayed. A secondary flush with a compatible fluid may be necessary. Use water for water-based materials.

- Turn ON/OFF switch to the **ON** position.
- Turn prime valve horizontal. Disengage trigger lock.
- Hold a metal part of the gun firmly to a grounded metal pail. Trigger gun and flush until clean.
- Turn ON/OFF switch to the **OFF** position.
- Engage trigger lock.
- Sprayer is now ready to startup and spray.

## Bag Roller (Optional)

Assemble roller assembly to the sprayer:

- Secure bag roller mounting frame to sprayer.
- Place roller assembly on the mounting frame.
- On the APX 5200/6200 models position the bag roller assembly in the lower position.
- On the APX 8200 model position the bag roller assembly in the upper position.
- Place bag roller on top of the sprayer and secure with hardware provided.
- The bag roller length is adjustable to accommodate various material bag lengths. Adjust by loosening the two handle screws and sliding the extension in or out.
- Increase bag roller tension by adjusting the tension on the two screws.

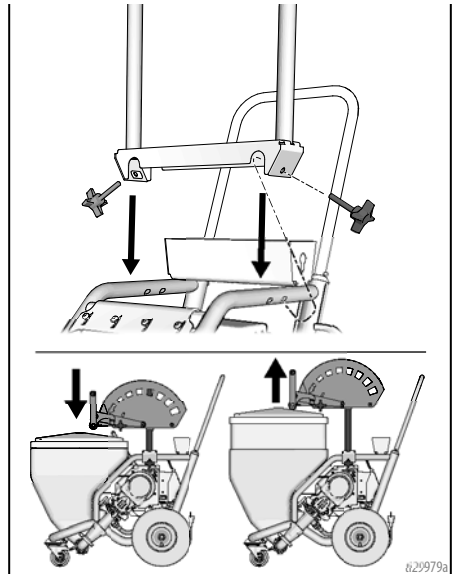

Bag roller handle can be removed to avoid damage when transporting sprayer.



## Start Up

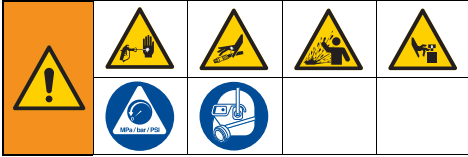

Perform the start up procedure each time the sprayer is started for the first time after it has been cleaned or stored.

1. Perform **Pressure Relief Procedure**, page 10.
2. Turn pressure control to lowest pressure.

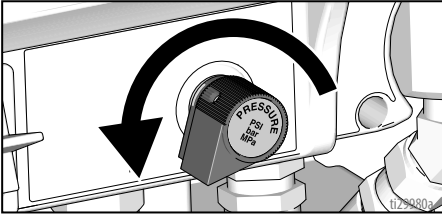

3. Turn ON/OFF switch to the **ON** position.

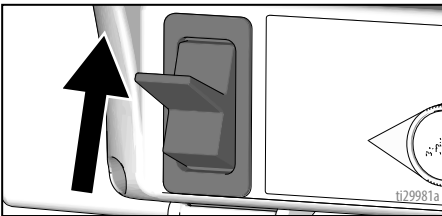

4. **6200/8200 models:** Turn VIBRA-FLO ON/OFF switch to the **ON** position.

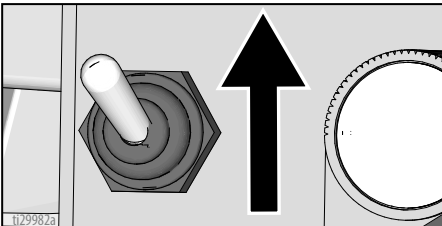

5. Increase pressure 1/2 turn to start motor and allow fluid to circulate through drain tube for 15 seconds; turn pressure down.

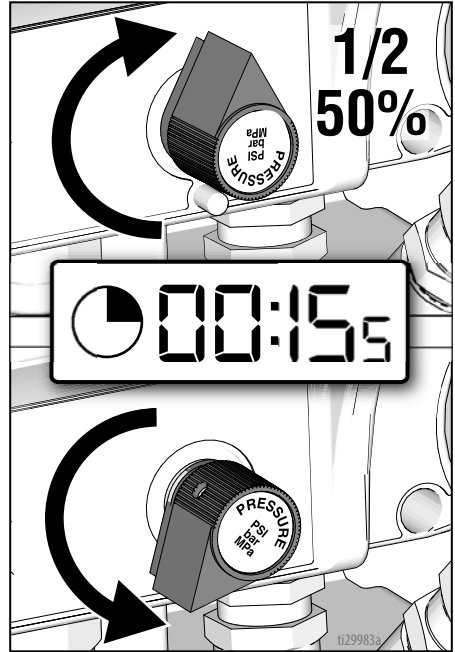

6. Turn prime valve horizontal to **SPRAY** position. Disengage trigger lock.

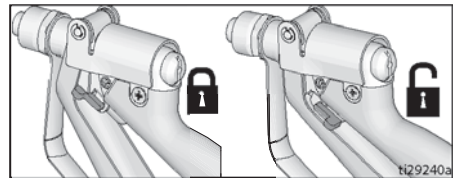

# Start Up

7. Hold gun against grounded metal flushing pail. Trigger gun and increase fluid pressure 1/2 turn. Flush 1 minute.

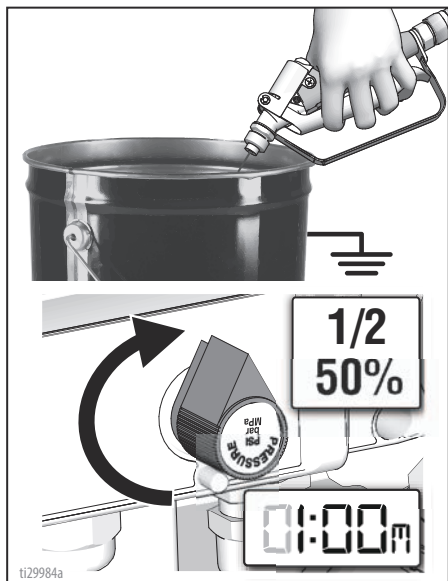

8. Inspect for leaks. If leaks occur, perform **Pressure Relief Procedure**, page 10. Tighten fittings. Perform **Start Up**, steps 2 - 6. If no leaks, proceed to **Prime Pump**, page 14.

## Prime Pump

Prime the pump before placing the hopper filter into the hopper.

1. Add 1-2 gallons (4-8 liters) of material to the hopper.
2. Place drain tube deflector shield into hopper or flushing pail. **Note:** Keep deflector shield wet once it is in use.
3. Turn ON/OFF switch to the **ON** position. Turn prime valve down.
4. Increase pressure to start pump.
5. Install hopper filter by pushing it through the material in the bottom of the hopper until it is in place. Open end of the filter should be pointed towards the pump inlet.

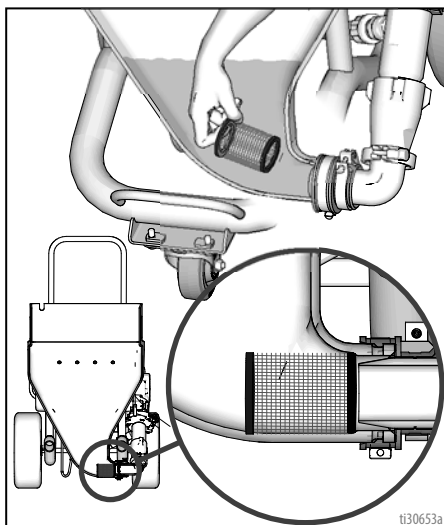

6. Add remaining material to the hopper.
7. Turn VIBRA-FLO knob to maximum.
8. If the shaker is making excessive noise turn the VIBRA-FLO knob to a lower setting. Depending upon the supply voltage the shaker may not operate if the VIBRA-FLO is set too low.
9. Turn prime valve forward to **SPRAY** position.

10. Trigger gun again into flushing pail until material appears. Move gun to hopper and trigger for 20 seconds.

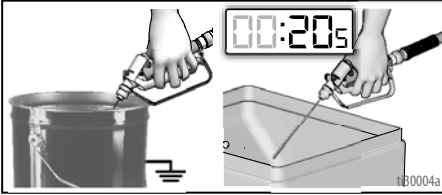

11. Engage trigger lock. Assemble tip and guard, see **Spray Tip Installation**, page 17.

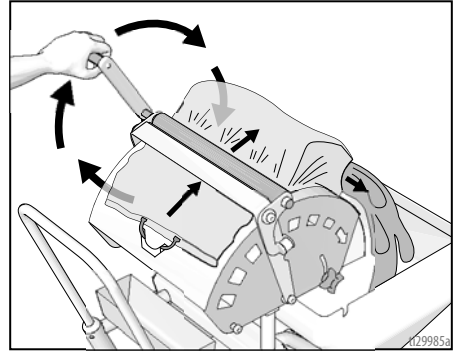
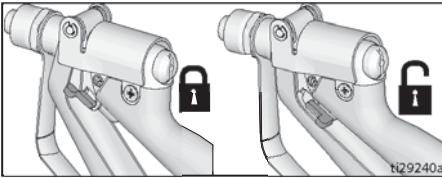

## VIBRA-FLO Shaker Adjustment (6200/8200 models)

The hopper shaker speed is adjusted by adjusting the VIBRA-FLO knob on the control.

1. Turn shaker ON/OFF switch to the ON position.

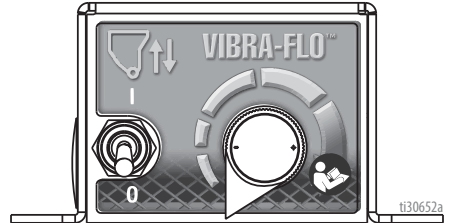

2. Turn VIBRA-FLO knob to maximum.
3. If the shaker is making excessive noise turn the VIBRA-FLO knob to a lower setting. Depending upon the supply voltage the shaker may not operate if the VIBRA-FLO is set too low.

## Bag Roller

1. Place bag of material on the bag roller.
2. Hook bag handle over bag roller hook.
3. Adjust bag roller length to the bag length.
4. Turn bag roller handle until roller contacts the bag.
5. Cut open the other end of the bag.
6. Turn bag roller handle to push contents into the hopper.
7. Turn bag roller handle the opposite direction to remove empty bag from the roller.

# Start Up

## Shaker Armature/Coil Adjustment

The hopper shaker is shipped with the gap preset for the best performance. If the armature and coil is replaced or needs adjustment, use a feeler gauge to adjust shaker gap. Set gap to 0.042 – 0.052 inch (1.06 – 1.32 mm).

1

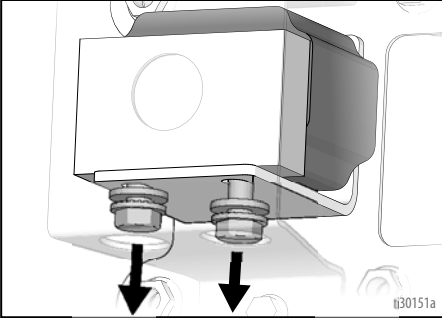

2

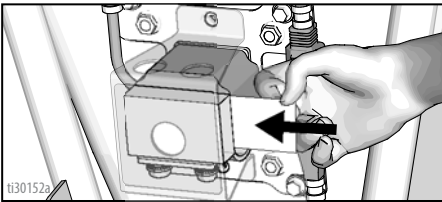

3

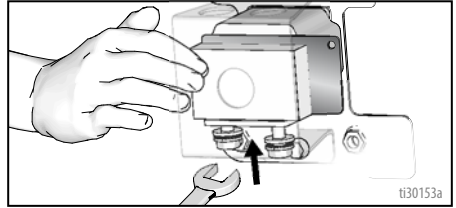

4

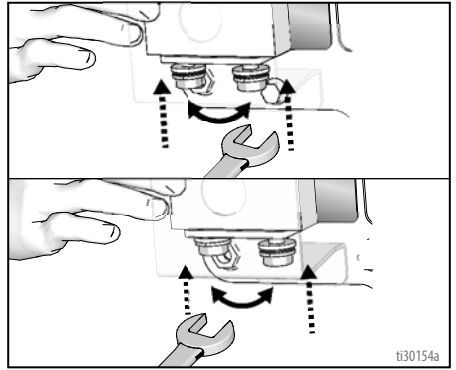

5

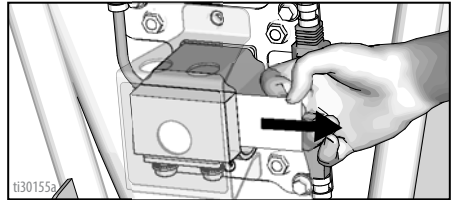

## Operation

### Spray Tip Installation



1. Perform **Pressure Relief Procedure**, page 10.
2. Engage trigger lock.
3. Verify spray tip and tip guard parts are assembled in the order shown.

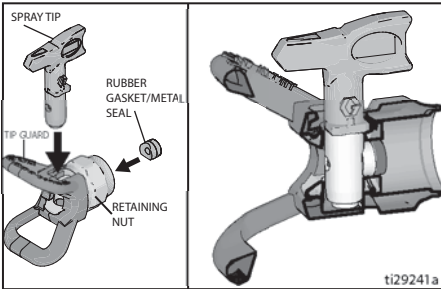

- a. Use spray tip to align gasket and seal in the tip guard.

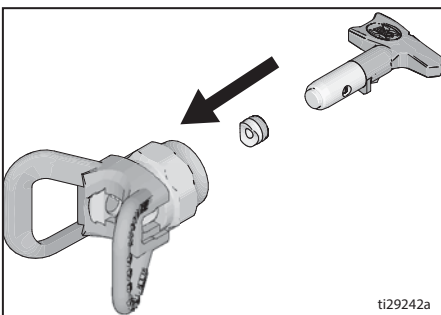

- b. Spray tip must be pushed all the way into the tip guard. Turn spray tip to push down.
- c. Turn the arrow shaped handle on the spray tip forward to the spray position.

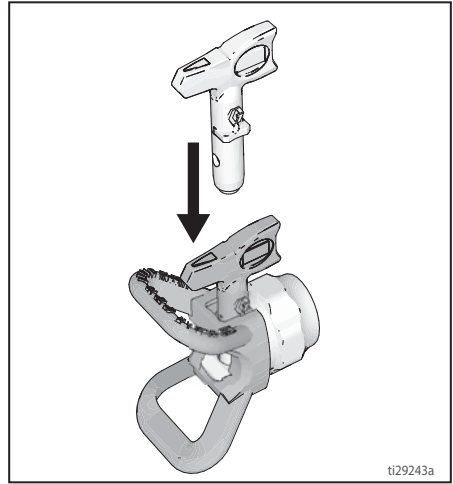

4. Screw spray tip and tip guard assembly onto the gun and tighten.

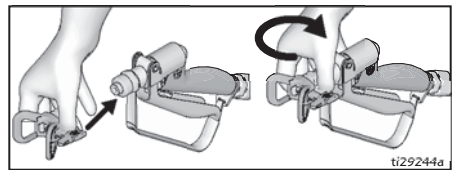

# Operation

## Clear Tip Clog



To avoid serious injury from skin injection do not put your hand in front of the spray tip when installing or removing the spray tip and tip guard.

To avoid tip clogs:

- When the gun is not in use for extended periods of time, keep the tip “wet” and perform **Pressure Relief Procedure**, page 10.
  - Keep tip clean and free of material.
  - Engage trigger completely when spraying. Partial trigger engagement increases the chances of tip clogs.
1. Engage trigger lock. Rotate spray tip to unclog position. Disengage trigger lock. Trigger gun at waste area to clear clog.

### UNCLOG

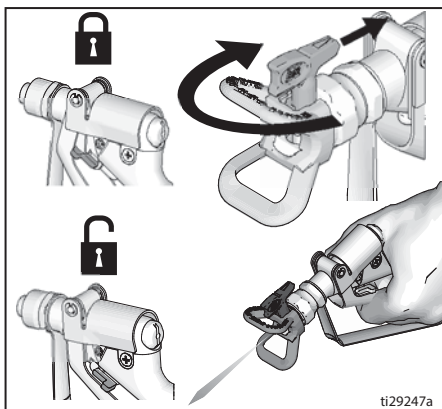

**NOTE:** If spray tip is difficult to rotate when turning to the unclog position perform, **Pressure Relief Procedure**, page 10, then turn Prime/Spray valve to spray position and repeat step 1.

2. Engage trigger lock. Rotate spray tip back to spray position. Disengage trigger lock and continue spraying.

### SPRAY

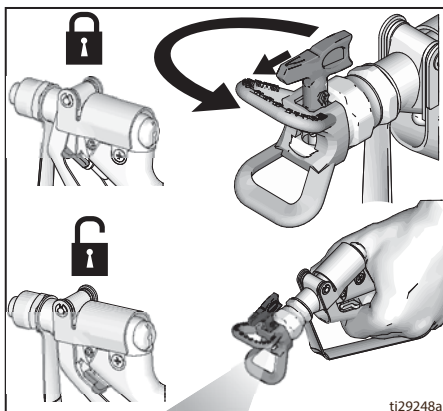

## Useful Tip

When spraying, if the gun is not used for a significant period of time be sure to clean the sprayer, or keep the gun “wet” by placing in water or wrapping with a wet cloth. This reduces the potential of the material drying in the gun causing pack-out of the gun.

## ProGuard Error Codes

This sprayer protects itself against high and low voltage. One of three error codes is displayed if the supply voltage is out of range.

Error Code	Definition
	<p><b>Multiple incoming voltage surges detected - unplug sprayer and locate good voltage supply to prevent damage to electronics.</b></p> <p>Typical cause of this error is plugging into a circuit that is higher than the rated voltage of the sprayer. Find a circuit that supplies the correct voltage.</p>
	<p><b>Incoming voltage too low for sprayer operation - unplug sprayer and locate good voltage supply to prevent damage to electronics.</b></p> <p>Typical cause of this error is other equipment on the same circuit or generator frequently turning on/off under load. Find a circuit that is dedicated to the sprayer.</p>
	<p><b>Sprayer plugged into wrong voltage - unplug sprayer and locate correct voltage supply.</b></p> <p>Typical cause of this error is a GFCI box that is wired for the wrong voltage (240V vs. 120V). No damage has occurred to the sprayer. Find a circuit with the correct voltage and the sprayer will run correctly.</p>

## Digital Tracking System (DTS)

### Operation Main Menu

Short press to move to next display. Press and hold (5 seconds) to change units or reset data.

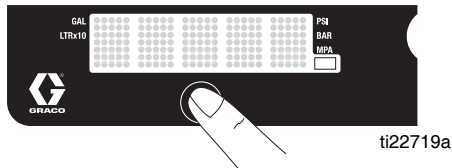

1. Turn pressure to lowest setting. Trigger gun to relieve pressure. Turn prime valve down to DRAIN position.

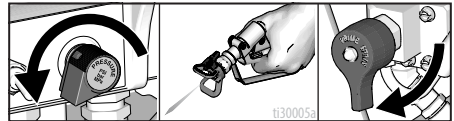

2. Turn ON/OFF switch to the **ON** position. Pressure display appears. Dashes will not appear unless pressure is less than 200 psi (14 bar, 1,4 MPa).

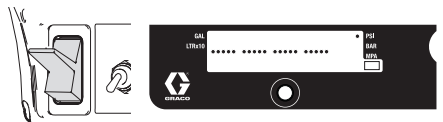

# Operation

## Change Display Units

Press and hold DTS button for 5 seconds to change pressure units (**psi**, **bar**, **MPa**) to desired units. Selection of bar or MPa changes **gallons** to **liters x 10**. To change display units DTS must be in pressure display mode and pressure must be at zero.

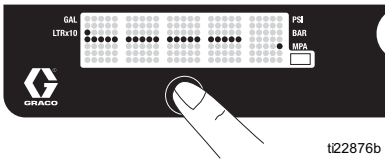
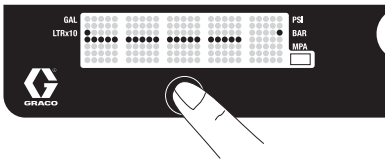
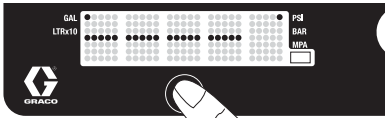

t22876b

## Job Gallons

1. Short press DTS button to move to Job Gallons (or liters x 10).

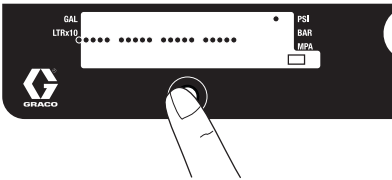

t22717b

2. Press and hold to reset to zero.  
**NOTE:** **JOB** scrolls past, then the number of gallons sprayed above 400 psi (28 bar, 2.8 MPa) displays.

## Lifetime Gallons

1. Short press DTS button to move to Lifetime Gallons (or liters x 10).

**NOTE:** **LIFE** scrolls briefly, then the number of gallons sprayed above 400 psi (28 bar, 2.8 MPa) displays.

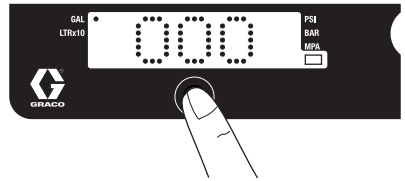

t22718b



## Secondary Menu - Stored Data

1. Perform **Pressure Relief Procedure**, steps 1 - 4 if they have not already been done.
2. Turn ON/OFF switch to the **ON** while holding DTS button down.

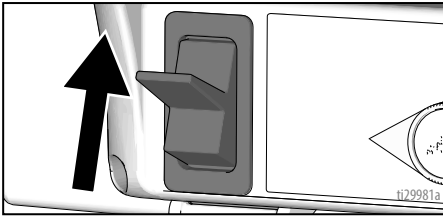
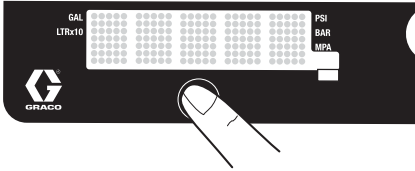

3. **SERIAL NUMBER** scrolls past and then serial number (e.g. 00001) displays.

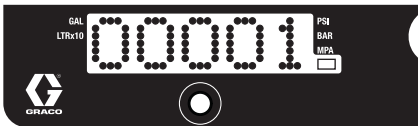
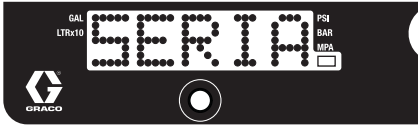

ti22720b

4. Short press DTS button and **MOTOR HOURS** scrolls past and then total motor run hours are displayed.
5. Short press DTS button. **LAST CODE** scrolls by and last code is displayed; e.g. **E=07**.

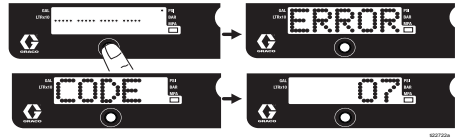

6. Press and hold DTS button to clear code to zero.



ti22723a

7. Short press to move to **SOFTWARE REV**.
8. Short press DTS button. **MOTOR ID RESISTOR** scrolls by and model code number (see below).

Motor ID Number	Models
6	APX 5200/6200
10	APX 8200

# Operation

## Cleanup

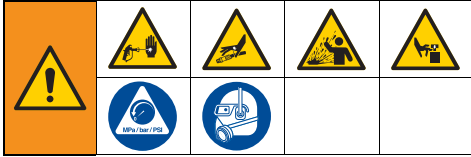

1. Perform **Pressure Relief Procedure**, page 10.
2. Remove tip guard and Spray Tip. For additional information, see separate gun manual.

**NOTE:** For cleanup and flushing, use water for water-base material.

3. Turn ON/OFF switch to the **ON** position. Turn prime valve forward to **SPRAY** position.

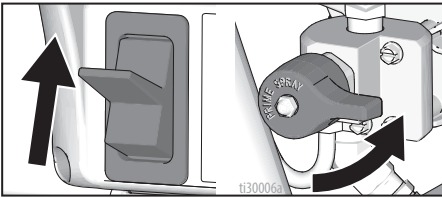

4. Scrape material out of the hopper. Add flushing fluid to the hopper.
5. Increase pressure to 1/2. Hold gun against pail. Disengage trigger lock. Trigger gun until flushing fluid appears.

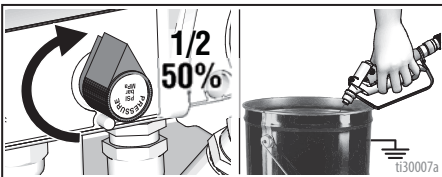

6. Move gun to waste pail, hold gun against pail, trigger gun to thoroughly flush system. Release trigger and engage trigger lock.

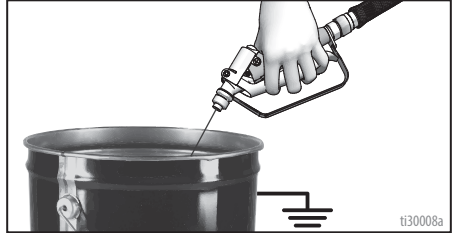

7. Turn prime valve down to **DRAIN** position and allow flushing fluid to circulate until flushing fluid appears clear.

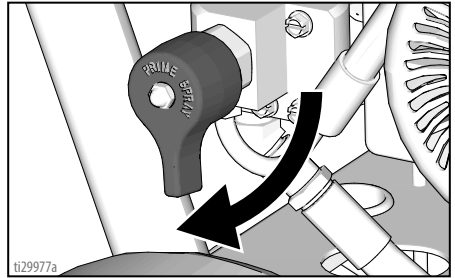

8. Turn prime valve forward to **SPRAY** position. Trigger gun into flushing pail to purge fluid from hose.

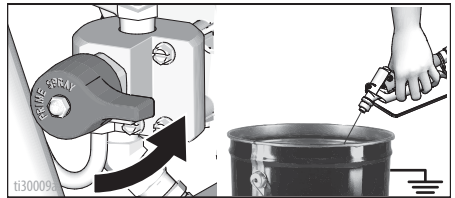

9. Add flushing fluid to the hopper and run sprayer until the hopper is empty. Turn ON/OFF switch to the **OFF** position.

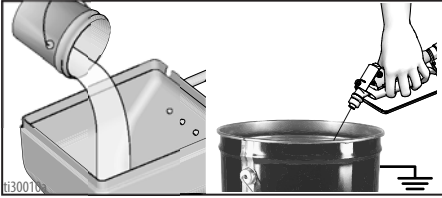

10. Turn prime valve down DRAIN position. Unplug sprayer.

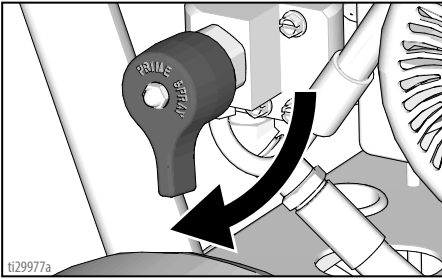

11. If flushing with water flush again with Pump Armor, to leave a protective coating to prevent freezing or corrosion.



12. Wipe sprayer, hose and gun with a rag soaked in water.

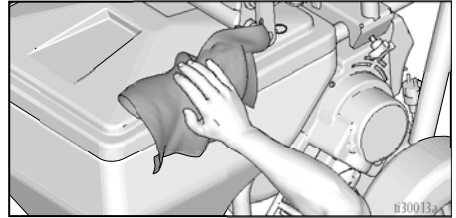

## Troubleshooting

### Mechanical/Fluid Flow

1. Follow **Pressure Relief Procedure**, page 10, before checking or repairing.
2. Check all possible problems and causes before disassembling unit.



Problem	Cause	Solution
CODE XX is displayed.	Fault condition exists	Determine fault correction from table, page 27.
Pump output is low	Spray tip worn	Follow <b>Pressure Relief Procedure</b> on page 10, then replace tip. See your separate gun or tip manual.
	Spray tip clogged	Relieve pressure. Check and clean spray tip.
	Material supply	Refill and reprime pump.
	Hopper strainer clogged	Remove and clean, then reinstall. Hopper filter is too fine. Remove filter or replace with a larger mesh filter.
	Intake valve ball and piston ball are not seating properly	Remove intake valve and clean. Check balls and seats for nicks; replace if necessary; see pump manual.
	Prime valve leaking	Relieve pressure. Repair prime valve.
	Verify pump does not continue to stroke when gun trigger is released. (Prime valve not leaking.)	Service pump; see pump manual.
	Hopper seal leaking	Make certain hopper outlet clamps are tight and flange O-ring is in place.
	Material is too thick for proper VIBRA-FLO shaker operation	Thin material
Material not flowing into pump	Increase VIBRA-FLO setting or thin material	

<b>Problem</b>	<b>Cause</b>	<b>Solution</b>
Pump output is low	Pump rod damage	Repair pump. See pump manual.
	Low stall pressure	Turn pressure knob fully clockwise. Make sure pressure control knob is properly installed to allow full clockwise position. If problem persists, replace pressure transducer.
	Piston packings are worn or damaged	Replace packings; see pump manual.
	O-ring in elbow is worn or damaged	Replace o-ring.
	Intake or piston valve ball is packed with material or worn	Clean piston or intake valve, or replace balls; see pump manual.
	Pressure setting is too low	Increase pressure; see pump manual.
	Large pressure drop in hose with heavy materials	Use larger diameter hose and/or reduce overall length of hose.
	Check to see if Amp switch (10/16) or (15/20) is on low setting. Make sure circuit is able to provide high setting.	Switch to 16A or 20A setting. Change to circuit that provides 16A or 20A. Change to less loaded circuit.
Motor runs but pump does not stroke	Connecting rod assembly damaged; see pump manual.	Replace connecting rod assembly; see pump manual.
	Gears or drive housing damaged.	Inspect drive housing assembly and gears for damage and replace if necessary; see pump manual.
Excessive material leakage into throat packing nut	Throat packing nut is loose	Remove throat packing nut spacer. Tighten throat packing nut just enough to stop leakage.
	Throat packings are worn or damaged	Replace packings; see pump manual.
	Displacement rod is worn or damaged	Replace rod; see pump manual.
Fluid is spitting from gun	Air in pump or hose	Check and tighten all fluid connections. Cycle pump as slowly as possible during priming.
	Tip is partially clogged	Clear tip; see operation manual.
	Fluid supply is low or empty	Refill fluid supply. Prime pump; see pump manual. Check fluid supply often to prevent running pump dry.

# Troubleshooting

Problem	Cause	Solution
Pump is difficult to prime	Air in pump or hose	Check and tighten all fluid connections. Cycle pump as slowly as possible during priming.
	Intake valve or piston valve is stuck or leaking	Clean intake and piston valve. Be sure ball seat is not nicked or worn and that ball seats well. Reassemble valve.
	Pump packings are worn	Replace pump packings; see pump manual.
	Material is too thick	Thin the material according to supplier recommendations.
	Hopper connections are not tight or elbow o-ring is damaged or missing	Check hopper connections and tighten as necessary. Inspect for o-ring. Replace o-ring if it is damaged.
No display, sprayer operates	Display is damaged or has bad connection	Check connections. Replace display.
VIBRA-FLO shaker does not run	No power	Make certain sprayer and shaker ON/OFF switches are <b>ON</b> .
	Shaker coil is defective	Replace shaker coil.
VIBRA-FLO shaker is too loud	Adjust shaker speed.	Turn shaker adjustment knob to a lower setting.
	Coil contacting armature block	Use feeler gauge to adjust shaker gap. See <b>VIBRA-FLO Shaker Adjustment (6200/8200 models)</b> , page 15.

## Electrical

Symptom: Sprayer does not run, stops running, or will not shut off.



Perform **Pressure Relief Procedure**, page 10.

1. Plug sprayer into correct voltage, grounded outlet.
2. Turn the ON/OFF switch **OFF**. Wait 30 seconds and then turn power back **ON** again (this ensures sprayer is in normal run mode).

3. Turn pressure control knob clockwise 1/2 turn.
4. View digital display.



Keep clear of electrical and moving parts during troubleshooting procedures. To avoid electrical shock hazards when covers are removed for troubleshooting, wait 5 minutes after disconnecting power cord for stored electricity to dissipate.

Problem	What to Check	How to check
Sprayer does not run at all	See flow chart, page 35.	
Display is blank		
Control board status light never light		

# Troubleshooting

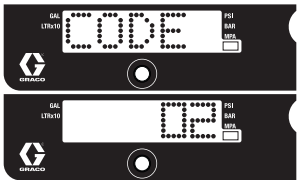
Problem	What to Check	How to check
<p>Sprayer does not run at all Display shows CODE 02</p> 	<p>Check transducer or transducer connections</p>	<ol style="list-style-type: none"> <li>1. Make sure there is no pressure in the system (see <b>Pressure Relief Procedure</b>, page 10). Check fluid path for clogs.</li> <li>2. Use airless paint spray hose with no metal braid 5/8 in. x 50 ft minimum. Smaller hose or longer metal braid hose lengths may result in high-pressure spikes.</li> <li>3. Set sprayer to OFF and disconnect power to sprayer.</li> <li>4. Check transducer and connections to control board.</li> <li>5. Disconnect transducer from control board socket. Check that transducer and control board contacts are clean and secure.</li> <li>6. Reconnect transducer to control board socket. Connect power, set sprayer ON and control knob 1/2 turn clockwise. If sprayer does not run properly, set sprayer to OFF and go to next step.</li> <li>7. Install new transducer. Connect power, set sprayer ON and control knob 1/2 turn clockwise. Replace control board if sprayer does not run properly.</li> </ol>

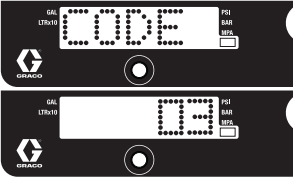
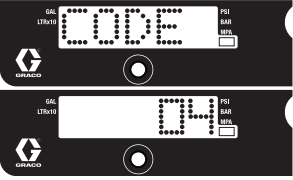

Problem	What to Check	How to check
<p>Sprayer does not run at all Display shows CODE 03</p> 	<p>Check transducer or transducer connections (control board is not detecting a pressure signal).</p>	<ol style="list-style-type: none"> <li>1. Set sprayer to OFF and disconnect power to sprayer.</li> <li>2. Check transducer and connections to control board.</li> <li>3. Disconnect transducer from control board socket. Check to see if transducer and control board contacts are clean and secure.</li> <li>4. Reconnect transducer to control board socket. Connect power, set sprayer ON and control knob to 1/2 turn clockwise. If sprayer does not run, set sprayer to OFF and go to next step.</li> <li>5. Connect a confirmed working transducer to control board socket.</li> <li>6. Set sprayer ON and control knob to 1/2 turn clockwise. If sprayer runs, install new transducer. Replace control board if sprayer does not run.</li> <li>7. Check transducer resistance with ohmmeter (less than 9k ohm between red and black wires and 3-6k ohm between green and yellow wires).</li> </ol>
<p>Sprayer does not run at all Display shows CODE 4</p> 	<p>Check voltage supply to the sprayer (control board is detecting a multiple voltage surges).</p>	<ol style="list-style-type: none"> <li>1. Set sprayer to OFF and disconnect power to sprayer.</li> <li>2. Locate a good voltage supply to prevent damage to electronics.</li> </ol>

# Troubleshooting

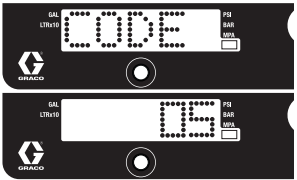
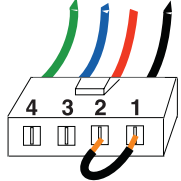
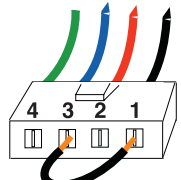
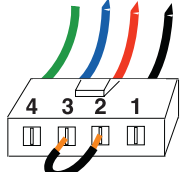
Problem	What to Check	How to check
<p data-bbox="46 191 280 256">Sprayer does not run at all Display shows CODE 05</p> 	<p data-bbox="375 191 673 402">Control is commanding motor to run but motor shaft does not rotate. Possibly locked rotor condition, an open connection exists between motor and control, there is a problem with motor or control board, or motor amp draw is excessive.</p>	<ol data-bbox="691 194 1005 938" style="list-style-type: none"> <li>1. Remove pump and try to run sprayer. If motor runs, check for locked or frozen pump or drive train. If sprayer does not run, continue to step 2.</li> <li>2. Set sprayer to OFF and disconnect power to sprayer.</li> <li>3. Disconnect motor connector(s) from control board socket(s). Check that motor connector and control board contacts are clean and secure. If contacts are clean and secure, continue to step 4.</li> <li>4. Set sprayer to OFF and spin motor fan 1/2 turn. Restart sprayer. If sprayer runs, replace control board. If sprayer does not run, continue to step 5.</li> <li>5. <b>Perform Spin Test:</b> Test at large 4-pin motor field connector. Disconnect fluid pump from sprayer. Test motor by placing a jumper across pins 1 &amp; 2. Rotate motor fan at about 2 revolutions per second. A cogging resistance to motion should be felt at the fan. The motor should be replaced if no resistance is felt. Repeat for pin combinations 1 &amp; 3 and 2 &amp; 3. Pin 4 (the green wire) is not used in this test. If all spin test is positive, continue to step 6.</li> </ol> <div data-bbox="686 958 1005 1534" style="text-align: center;"> <p data-bbox="787 958 1005 982">Green Blue Red Black</p> <p data-bbox="686 1031 792 1055"><b>STEP 1:</b></p>  <p data-bbox="686 1226 792 1250"><b>STEP 2:</b></p>  <p data-bbox="686 1412 792 1437"><b>STEP 3:</b></p>  </div>

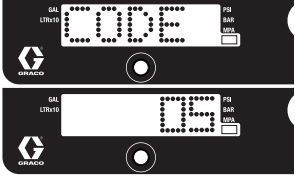
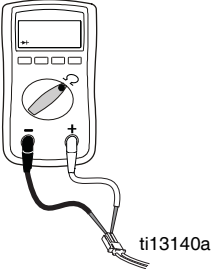
Problem	What to Check	How to check						
<p>Sprayer does not run at all</p> <p>Display shows CODE 05</p> 	<p>Control is commanding motor to run but motor shaft does not rotate. Possibly locked rotor condition, an open connection exists between motor and control, there is a problem with motor or control board, or motor amp draw is excessive.</p>	<p><b>6. Perform Field Short Test:</b> Test at large 4-pin motor field connector. There should not be continuity from pin 4, the ground wire, and any of the remaining 3 pins. If motor field connector tests fail, replace motor.</p> <p><b>7. Check Motor Thermal Switch:</b> Unplug thermal wires. Set meter to ohms. Meter should read the proper resistance for each unit (see table below).</p>  <table border="1" data-bbox="729 781 1019 932"> <thead> <tr> <th colspan="2">Resistance Table:</th> </tr> </thead> <tbody> <tr> <td>APX 5200/ 6200</td> <td>6.2k ohms</td> </tr> <tr> <td>APX 8200</td> <td>10.0k ohms</td> </tr> </tbody> </table>	Resistance Table:		APX 5200/ 6200	6.2k ohms	APX 8200	10.0k ohms
Resistance Table:								
APX 5200/ 6200	6.2k ohms							
APX 8200	10.0k ohms							

# Troubleshooting

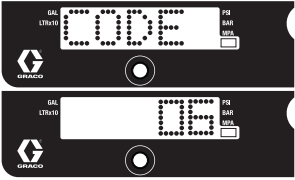
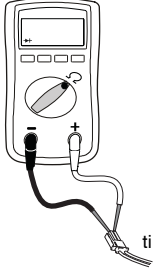
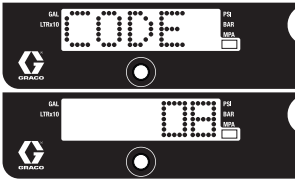
Problem	What to Check	How to check						
<p>Sprayer does not run at all Display shows CODE 06</p> 	<p>Allow sprayer to cool. If sprayer runs when cool, correct cause of overheating. Keep sprayer in cooler location with good ventilation. Make sure motor air intake is not blocked. If sprayer still does not run, follow Step 1.</p>	<p><b>NOTE:</b> Motor must be cooled down for the test.</p> <ol style="list-style-type: none"> <li>1. Check thermal device connector (yellow wires) at control board.</li> <li>2. Disconnect thermal device connector from control board socket. Make sure contacts are clean and secure. Measure resistance of the thermal device. If reading is not correct, replace motor.</li> </ol> <p><b>Check Motor Thermal Switch:</b> Unplug thermal wires. Set meter to ohms. Meter should read the proper resistance for each unit (see table below).</p>  <table border="1" data-bbox="703 907 994 1060"> <thead> <tr> <th colspan="2">Resistance Table:</th> </tr> </thead> <tbody> <tr> <td>APX 5200/ 6200</td> <td>6.2k ohms</td> </tr> <tr> <td>APX 8200</td> <td>10.0k ohms</td> </tr> </tbody> </table> <p>Reconnect thermal device connector to control board socket. Connect power, turn sprayer ON and control knob 1/2 turn clockwise. If sprayer does not run, replace control board.</p>	Resistance Table:		APX 5200/ 6200	6.2k ohms	APX 8200	10.0k ohms
Resistance Table:								
APX 5200/ 6200	6.2k ohms							
APX 8200	10.0k ohms							
<p>Sprayer does not run at all Display shows CODE 08</p> 	<p>Check voltage supply to the sprayer (incoming voltage too low for sprayer operation)</p>	<ol style="list-style-type: none"> <li>1. Set sprayer to OFF and disconnect power to sprayer.</li> <li>2. Remove other equipment that uses the same circuit.</li> <li>3. Locate a good voltage supply to avoid damage to electronics.</li> </ol>						

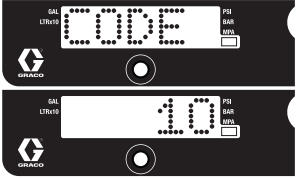
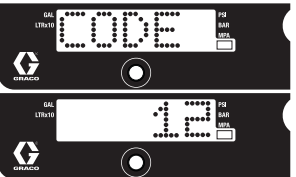
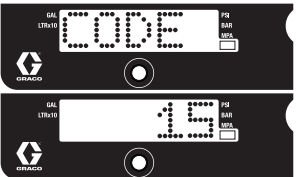
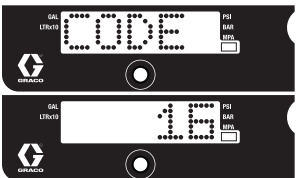
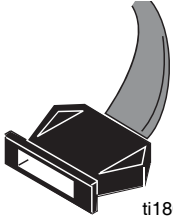
Problem	What to Check	How to check
<p>Sprayer does not run at all Display shows CODE 10</p> 	<p>Check to see if control board is over heating.</p>	<ol style="list-style-type: none"> <li>1. Make sure motor air intake is not blocked.</li> <li>2. Make sure fan has not failed.</li> <li>3. Make sure control board is properly connected to back plate and that conductive thermal paste is used on power components.</li> <li>4. Replace control board.</li> <li>5. Replace motor.</li> </ol>
<p>Sprayer does not run at all Display shows CODE 12</p> 	<p>Excessive current protection enabled</p>	<ol style="list-style-type: none"> <li>1. Cycle power on and off.</li> </ol>
<p>Sprayer does not run at all Display shows CODE 15</p> 	<p>Check the connections above the motor</p>	<ol style="list-style-type: none"> <li>1. Set sprayer to OFF and disconnect power to sprayer.</li> <li>2. Remove motor shroud.</li> <li>3. Disconnect motor control and inspect for damage at connectors.</li> <li>4. Reconnect motor control.</li> <li>5. Turn power on. If code continues, replace motor.</li> </ol>
<p>Sprayer does not run at all Digital display shows CODE 16</p> 	<p>Check the connections. Control is not receiving a motor position sensor signal</p>	<ol style="list-style-type: none"> <li>1. Turn power OFF.</li> <li>2. Disconnect motor position sensor and inspect for damage at connectors.</li> </ol>  <p style="text-align: right;">ti18685a</p> <ol style="list-style-type: none"> <li>3. Reconnect sensor.</li> <li>4. Turn power ON. If code continues, replace motor.</li> </ol>

# Troubleshooting

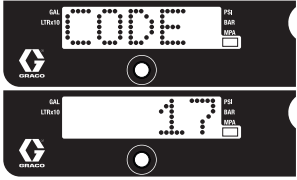
Problem	What to Check	How to check
<p>Sprayer does not run at all</p> <p>Display shows CODE 17</p> 	<p>Check voltage supply to the sprayer (plugged into wrong voltage)</p>	<ol style="list-style-type: none"><li>1. Set sprayer to OFF and disconnect power to sprayer.</li><li>2. Locate a good voltage supply to avoid damage to electronics.</li></ol>

## Sprayer Will Not Run

(See following page for steps)

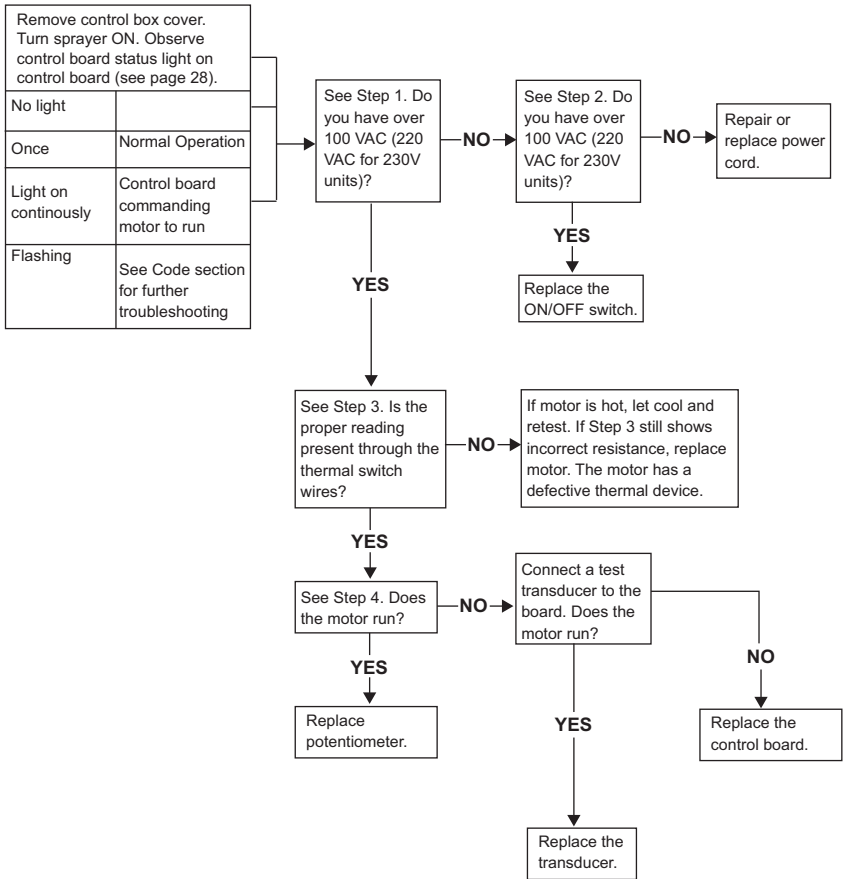

ti29217a

# Troubleshooting

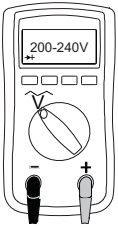

**STEP 1:**  
Plug power cord in and turn switch ON. Connect probes to on/off switch. Turn meter to AC volts

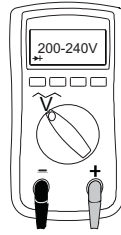
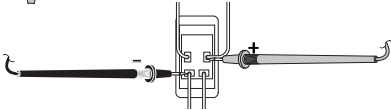

**STEP 2:**  
Plug power cord in and turn switch ON. Connect probes to on/off switch. Turn meter to AC volts

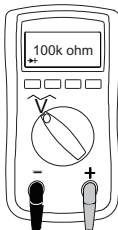
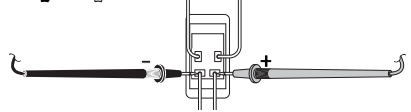

**STEP 3:**  
Check motor thermal switch. Unplug yellow wires. Meter should read according to Resistance Table on Page 31.  
**NOTE:** Motor should be cool during reading.

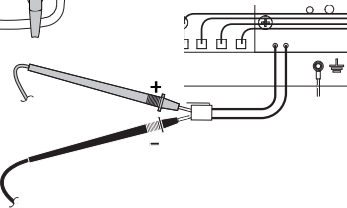

**STEP 4:**  
Plug power cord in and turn switch ON. Disconnect potentiometer.

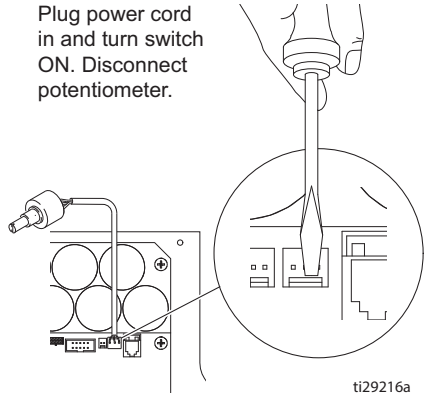

ti29216a

## Sprayer Will Not Shut Off

1. Perform **Pressure Relief Procedure**, page 10. Leave prime valve open and ON/OFF switch **OFF**.

2. Remove control box cover so the control board status light can be viewed if available.



## Troubleshooting Procedure

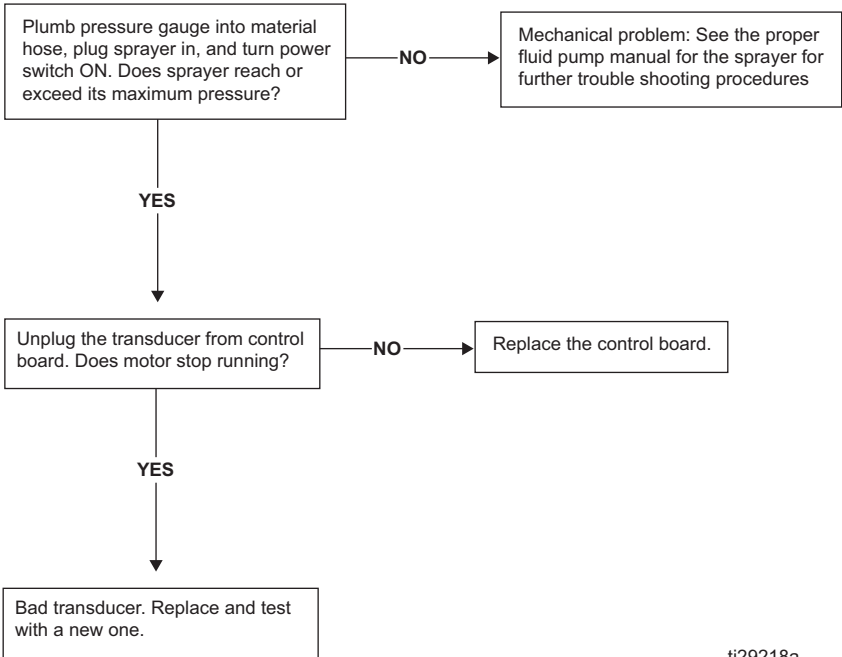

ti29218a

# APX Cart Parts

## APX Cart Parts

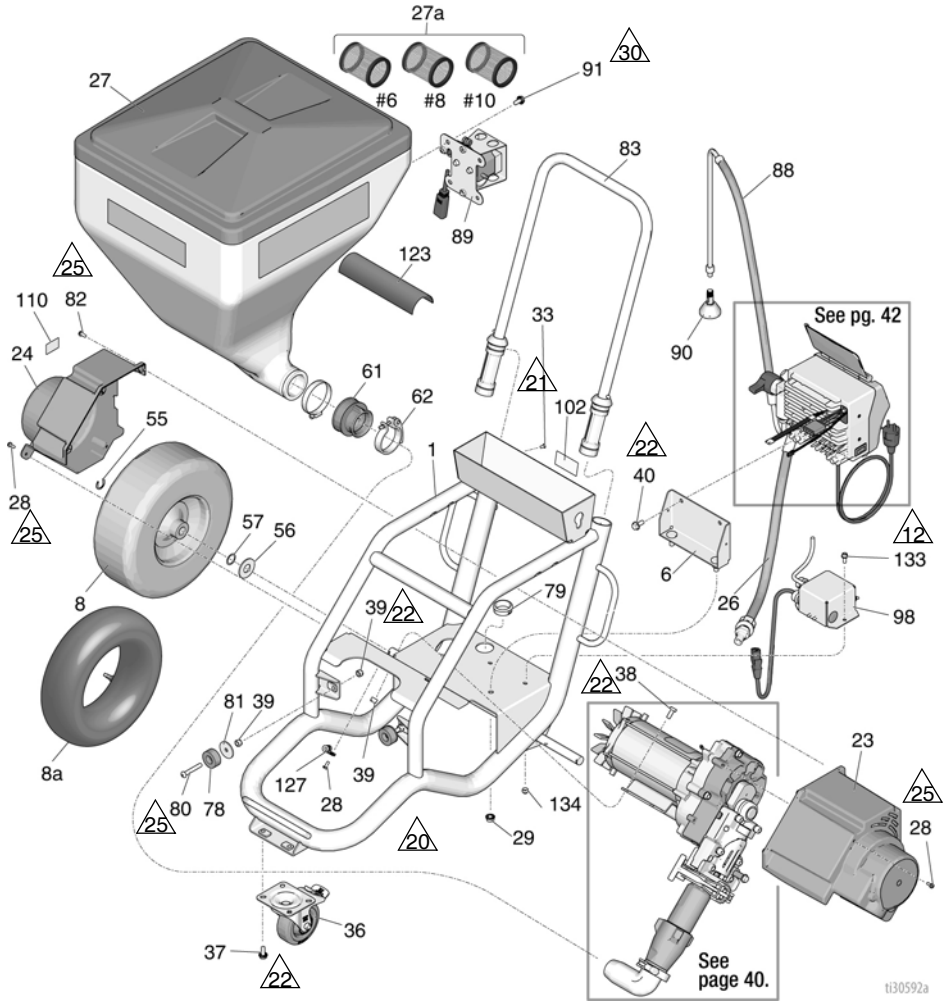

Ref.	Torque	Ref.	Torque
△12	70-80 in-lb (7.9 - 9.0 N•m)	△22	200-230 in-lb (22.6 - 26 N•m)
△20	25-30 ft-lb (33.9 - 40.1 N•m)	△25	30-35 in-lb (3.4 - 3.9 N•m)
△21	22-28 in-lb (2.5 - 3.2 N•m)	△30	170-190 in-lb (19.2 - 21.5 N•m)

## APX Cart Parts List

Ref.	Part	Description	Qty.	Ref.	Part	Description	Qty.
1	17N502	CART, painted	1	81	112717	WASHER	2
6	17N679	BRACKET, control	1	82	114000	SCREW, machine, HWH	3
8	119509	WHEEL, pneumatic	2	83	17N920	ASSEMBLY, handle	1
8a	253131	KIT, repair, tube	1	88	17P774	KIT, hose, drain <i>includes 90</i>	1
23	17N939	SHIELD, drive, painted	1	89	17N661	SHAKER, texture, (APX 6200/8200) See page 44 for parts.	1
24		SHIELD, motor, painted		90	241920	DEFLECTOR, threaded	1
	17N940	APX 5200/6200	1	91	111800	SCREW, cap hex head	4
	17N941	APX 8200	1	98	17S013	BOX, control, shaker, (APX 6200/8200) See page 45 for parts.	1
26	16X905	HOSE, coupled, 1/2"	1	102▲	16G596	EU LABEL, warning	1
27		ASSEMBLY, hopper	1		16Y762	AP	1
	17P817	APX 6200, 17 gal. (26.5L) <i>includes 123</i>	1		16T784	English, French, Spanish	
	17P818	APX 5200/8200, 25 gal. (94.6L) <i>includes 123</i>	1	123	17H490	PAD, isolator, hopper	1
27a		FILTER, hopper	1	127	17P261	CLAMP, loop, cushioned	1
	17R160	#6		133	108296	SCREW, machine, HWH	2
	17P460	#8 (standard)		134	102040	NUT, lock, hex	2
	17R314	#10		▲		Medical alert card (not shown)	
28	118444	SCREW, machine, HWH	6		222385	English, Spanish, French	1
29	112958	NUT, hex, flanged	2		17R476	English, Spanish, Portuguese	1
33	108795	SCREW, machine, PNH	4		17A134	English, Chinese, Korean	1
36	17N602	CASTER, swivel	1		17F690	Dutch, German, Italian	1
37	110963	SCREW, cap, flange head	4				
38	100057	SCREW, cap hex head	4				
39	111040	NUT, lock	8				
40	117791	SCREW, cap	2				
55	15E891	CLIP, retaining	2				
56	156306	WASHER, flat	2				
57	116038	WASHER, wave spring	2				
61	15R609	FITTING, hopper, adapter	1				
62	234188	CLAMP, quick release	1				
78	113817	BUMPER	2				
79	113677	BUSHING	1				
80	551786	SCREW, cap, stainless	2				

▲ Replacement Danger and Warning labels, tags, and cards are available at no cost.

# APX Pump and Motor Parts

## APX Pump and Motor Parts

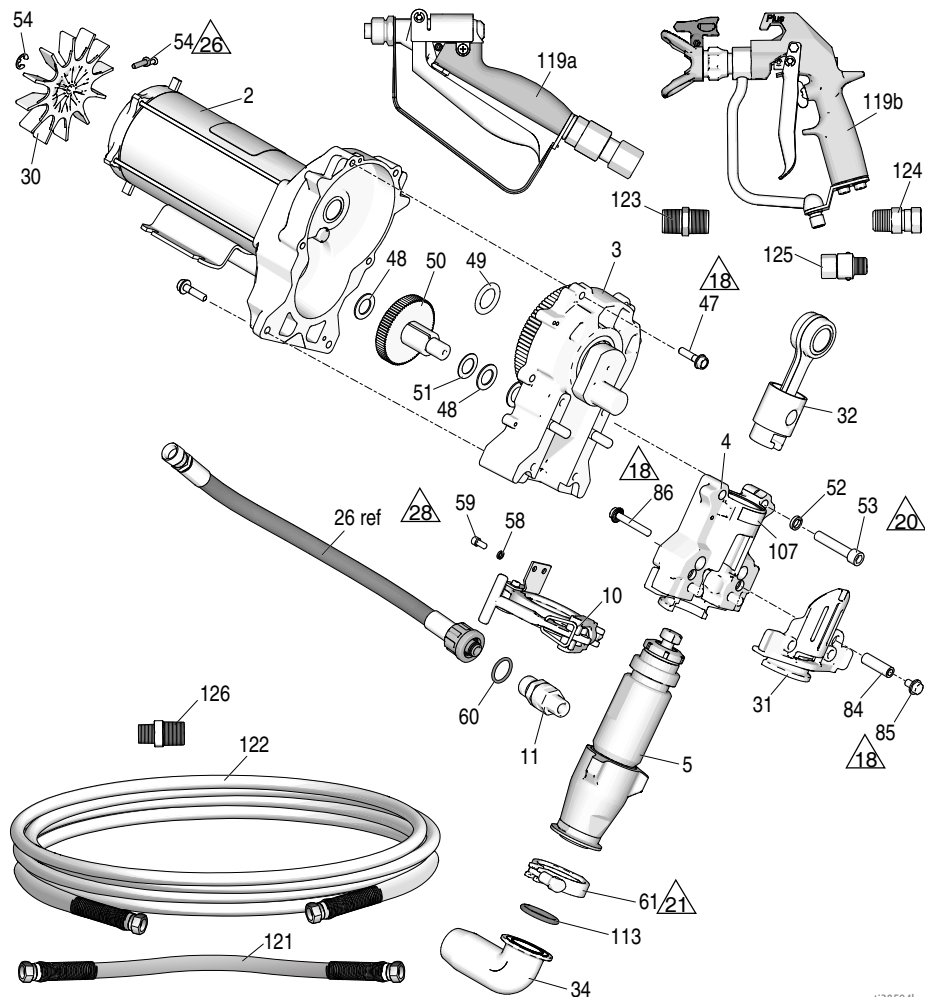

ti30594b

Ref.	Torque	Ref.	Torque
△18	190-210 in-lb (21.5 - 23.7 N•m)	△26	9-11 in-lb (1.1 - 1.2 N•m)
△20	25-30 ft-lb (33.9 - 40.1 N•m)	△28	90-110 in-lb (10.2 - 12.4 N•m)
△21	22-28 in-lb (2.5 - 3.2 N•m)		

# APX Pump and Motor Parts

## APX Pump and Motor Parts List

Ref.	Part	Description	Qty.	Ref.	Part	Description	Qty.
2		KIT, motor, electric <i>includes 30, 54</i>		50		KIT, repair, gear <i>includes 48, 51</i>	
	257188	APX 5200/6200	1		287290	APX 5200/6200	1
	258909	APX 8200	1		288035	APX 8200	1
3		KIT, drive, housing, repair		51	114699	WASHER, thrust	1
	287295	APX 5200 <i>includes</i> <i>47, 49</i>	1	52		WASHER, lock	
	24M417	APX 6200 <i>includes</i> <i>47, 49</i>	1		106115	APX 5200/6200	4
	287990	APX 8200 <i>includes</i> <i>47, 49</i>	1		112600	APX 8200	
4		HOUSING, bearing		53		SCREW, cap SH	
	17R743	APX 5200/6200 <i>includes 4, 10, 31, 52,</i> <i>53, 58, 59, 84, 85, 86,</i> <i>107</i>	1		114666	APX 5200/6200	4
	17R744	APX 8200 <i>includes 4,</i> <i>10, 31, 52, 53, 58, 59,</i> <i>84, 85, 86, 107</i>	1		112599	APX 8200	4
5		PUMP, chrome		54	115477	SCREW, machine, Torx, APX 5200/6200	1
	17R044	APX 5200/6200	1		122347	RING, retaining, external APX 8200	1
	17R042	APX 8200	1		58	105510	WASHER, lock
	17N942	CLAMP, pump	1		59	101550	SCREW, cap
10		FITTING, quick disconnect			60	102982	PACKING, o-ring
11					61	500984	CLAMP, tri-clamp
	16X834	APX 5200/6200	1		84	17N902	SPACER, threaded
	24U755	APX 8200	1		85	111801	SCREW, cap HH
30		FAN, motor			86	114653	SCREW, cap flange head
	15D088	APX 5200/6200	1	107	187437	LABEL, torque	1
	15V577	APX 8200	1	113	110831	PACKING, o-ring	1
31		PLATE, front		119a	245820	KIT, accessory, gun APX 6200/8200	1
	16X385	APX 5200/6200	1	119b	289605	KIT, accessory, gun APX 5200	1
	16X209	APX 8200	1	121	17N982	HOSE, cpld, 1/2" x 15' APX 6200/8200	1
32		ROD, connecting			191239	HOSE, cpld, 3/8" x 12' APX 5200	1
	16X964	APX 5200/6200	1	122	17N984	HOSE, cpld, 5/8" x 50' APX 6200/8200	1
	24V086	APX 8200	1		278499	HOSE, cpld, 1/2" x 50' APX 5200	1
34	17P815	TUBE, intake 90°	1	123	158491	FITTING, nipple APX 6200/8200	1
47	15C753	SCREW, machine HWH		124	189018	FITTING, swivel, gun APX 5200	1
		APX 5200/6200	5	125	110476	ADAPTER, union, swivel APX 5200	1
		APX 8200	6	126	159239	FITTING, nipple APX 5200	1
48	114672	WASHER, thrust	2				
49	116192	WASHER, thrust	1				

# APX Control and Manifold Parts

## APX Control and Manifold Parts

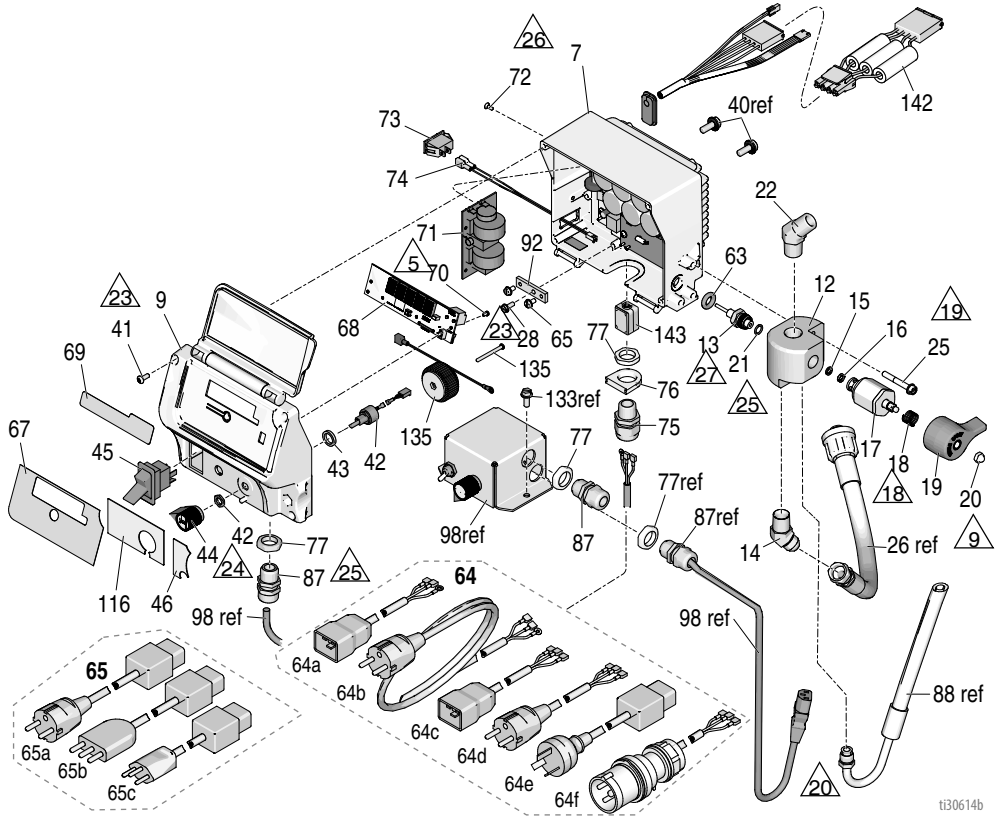

t130614b

Ref.	Torque	Ref.	Torque
	2-3 in-lb (0.23 - 0.34 N•m)		40-45 in-lb (4.5 - 5.1 N•m)
	15-25 in-lb (1.7 - 2.8 N•m)		10-15 in-lb (1.1 - 1.7 N•m)
	190-210 in-lb (21.5 - 23.7 N•m)		30-35 in-lb (3.4 - 3.9 N•m)
	100-120 in-lb (11.3 - 13.6 N•m)		9-11 in-lb (1.1 - 1.2 N•m)
	25-30 ft-lb (33.9 - 40.1 N•m)		35-45 ft-lb (47.5 - 61.1 N•m)

# APX Control and Manifold Parts

## APX Control and Manifold Parts List

Ref.	Part	Description	Qty.	Ref.	Part	Description	Qty.
7	17R029	BOARD, control (APX 6200/8200) <i>includes 25, 28, 40, 63, 65, 72, 76, 82</i>	1	64e	17A242	CORDSET, adapter, Australia	1
	17S871	BOARD, control (APX 5200) <i>includes 25, 28, 40, 63, 65, 72, 82</i>	1	64f	15D530	APX 5200, U.K.	1
9	17R757	COVER, control <i>includes 41, 46, 67, 68, 69, 77, 87, 116</i>	1	65	253103	Italy/Denmark/Switzerland	1
12	17N678	MANIFOLD, transducer	1	66	114391	SCREW, grounding	2
13	243222	TRANSDUCER, pressure control <i>includes 21</i>	1	67	16X796	LABEL, SmartControl3.0	1
14	117556	FITTING, nipple	1	68	16Y496	BOARD, display, LED <i>includes 70</i>	1
15	193710	SEAL, seat, valve	1	69	16X797	LABEL, SmartControl3.0, ProGuard	1
16	193709	SEAT, valve	1	70	115522	SCREW, machine	3
17	287879	ASSEMBLY, valve, drain	1	71	24R597	BOARD, filter	1
18	114708	SPRING, compression	1		24R598	APX 5200	1
19	15G563	HANDLE, valve	1		24R598	APX 6200	1
20	116424	NUT, cap	1		24U823	APX 8200	1
21	111457	PACKING, o-ring	1	72	119228	SCREW, machine	2
22	15J002	FITTING, elbow, 45°	1	73	126029	SWITCH, rocker (APX 6200/8200)	1
25	16U013	SCREW, machine, HWH	3		120059	SWITCH, rocker (APX 5200)	1
28	118444	SCREW, machine, HWH	1	74	15G935	CONNECTOR, electrical	1
41	16V095	SCREW, machine	4	75	117745	BUSHING, strain relief (APX 6200/8200)	1
42	256219	POTENTIOMETER	1	76	16T544	ADAPTER, cord (APX 6200/8200)	1
43	15C973	GASKET	1		16T546	ADAPTER, cord (APX 5200)	1
44	116167	KNOB, potentiometer	1	77	117625	NUT, locking (APX 6200/8200)	2
45	15D527	SWITCH, rocker, 240V (APX 6200/8200)	1	87	260067	FITTING, strain relief (APX 6200/8200)	1
	15C979	SWITCH, rocker, 120V (APX 5200)	1	92	17P272	BAR, ground (APX 6200/8200)	1
46	16Y788	LABEL, blank	1	116	17P395	LABEL, switch	1
63	121889	O-ring	1	126	121249	LOCK, cord	1
64		CORD, power		135	24V030	KIT, repair, coil filter, APX8200 <i>includes 136</i>	1
64a	16M836	APX 6200, Multicord, Model 17N343, 17N347	1	136	16U215	SCREW, Phillips PH	1
64b	16M834	APX 6200, CEE 7/7 Model 17N345	1	137	121249	RETAINER, plug adapter	1
64c	15G938	APX 8200, Models 17N350, 17N354	1	142	17N437	WIRE, jumper (APX 5200)	1
64d	15G957	APX 8200, CEE 7/7 Model 17N352	1	143	17V290	SUPPRESSOR, ferrite (APX 5200)	1

# APX VIBRA-FLO Shaker Parts

## APX VIBRA-FLO Shaker Parts

### APX 6200/8200

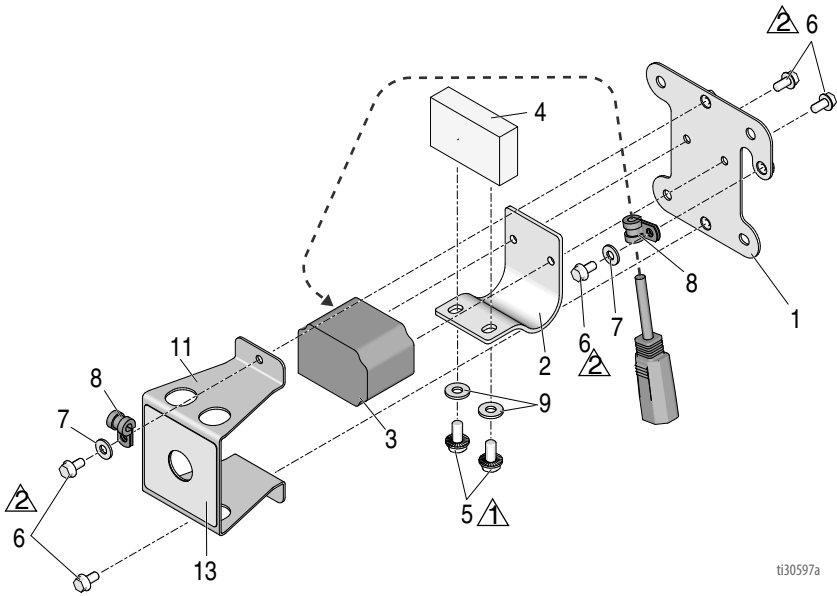

ti30597a

Ref.	Torque	Ref.	Torque
△1	170-190 in-lb (19.2 - 21.5 N•m)	△2	80-100 in-lb (9.0 - 11.2 N•m)

Ref.	Part	Description	Qty.	Ref.	Part	Description	Qty.
1	17N609	PLATE, shaker	1	7	110755	WASHER, flat	2
2	17N607	BRACKET, mounting, armature	1	8	17P261	CLAMP, loop, cushioned	2
3	17N608	COIL, electromagnetic, 230V	1	9	100527	WASHER, flat	2
4	17N606	BLOCK, armature	1	11	17P658	GUARD, shaker	1
5	111800	SCREW, cap, HH	2	13	17P396	LABEL, branding, shaker	1
6	113161	SCREW, flange, HH	5				



# APX VIBRA-FLO Shaker Control Parts

## APX VIBRA-FLO Shaker Control Parts

### APX 6200/8200

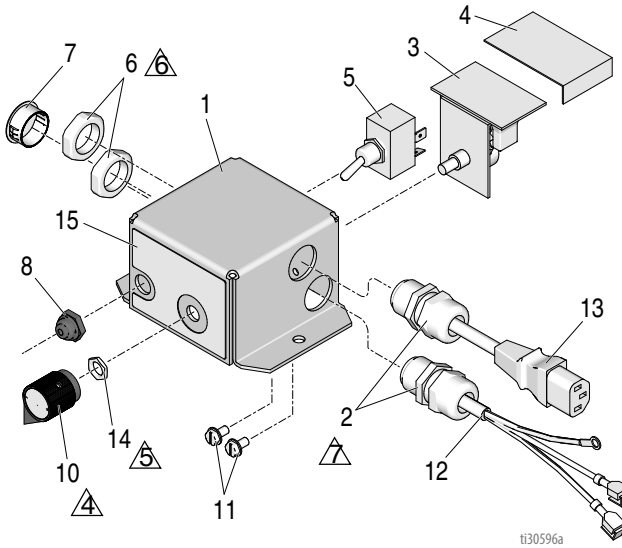

Ref.	Torque	Ref.	Torque
△4	10-15 in-lb (1.1 - 1.7 N•m)	△6	40-45 in-lb (4.5 - 5.1 N•m)
△5	22-28 in-lb (2.5 - 3.2 N•m)	△7	30-35 in-lb (3.4 - 3.9 N•m)

Ref.	Part	Description	Qty.	Ref.	Part	Description	Qty.
1	17R129	ENCLOSURE, control	1	10	116167	KNOB, potentiometer	1
2	260067	FITTING, strain relief, 1/2 NPT	2	11	114391	SCREW, grounding	2
3	17S020	BOARD, control, shaker	1	12	17R137	CORD, junction, shaker box	1
4	17R471	INSULATOR, box	1	13	17P188	CORD, set	1
5	195429	SWITCH, toggle	1	14	119775	NUT, panel	1
6	117625	NUT, locking	2	15	17R346	LABEL, control, shaker	1
7	123812	PLUG, hole	1	16	17P082	WIRE, jumper, brown, not shown	1
8	195428	BOOT, toggle	1		17S013	CONTROL, shaker, complete	1
9	17J017	LABEL	1			<i>includes 1 -16</i>	

## Wiring Diagrams APX 5200

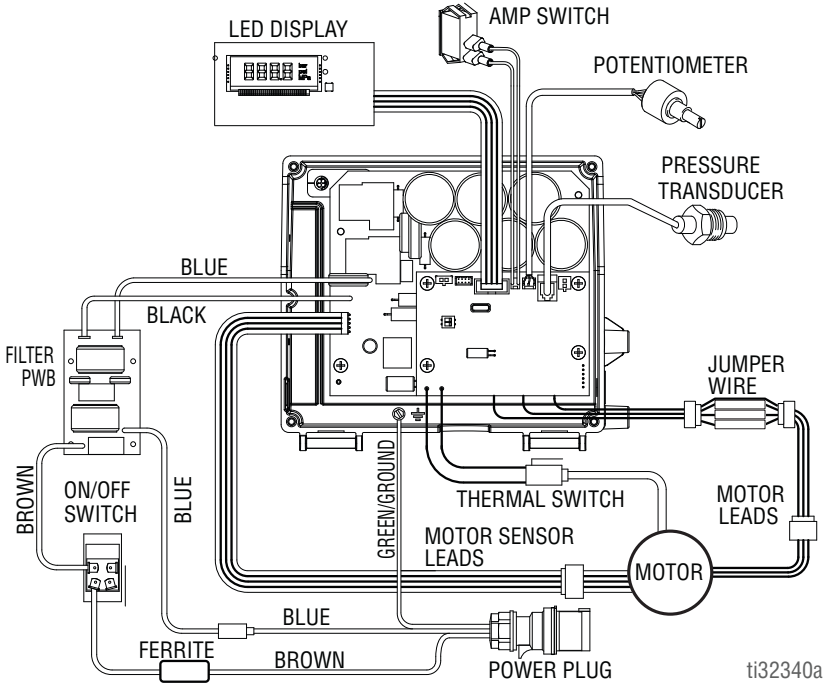

# Wiring Diagrams

## APX 6200/8200

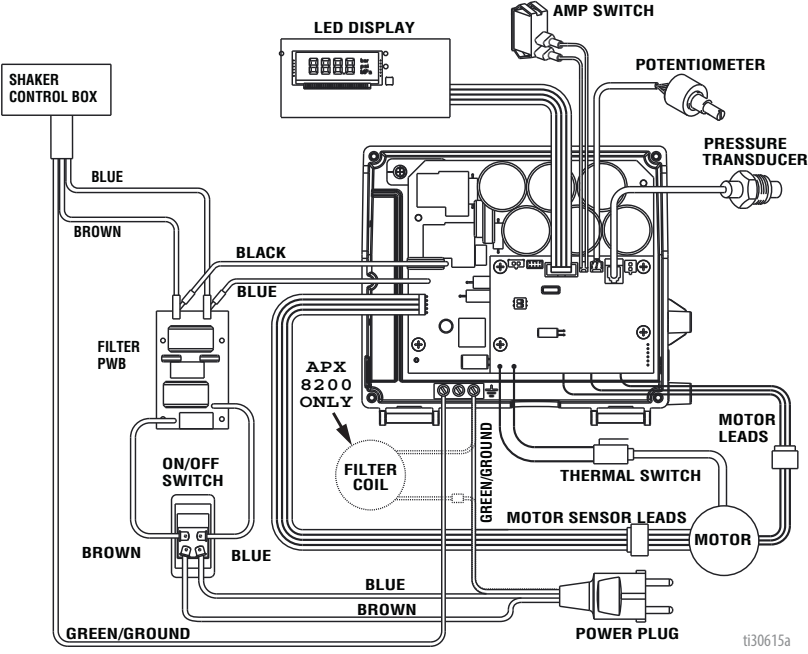

## Shaker Control Box

WIRING DIAGRAM - SHAKER CONTROL BOX

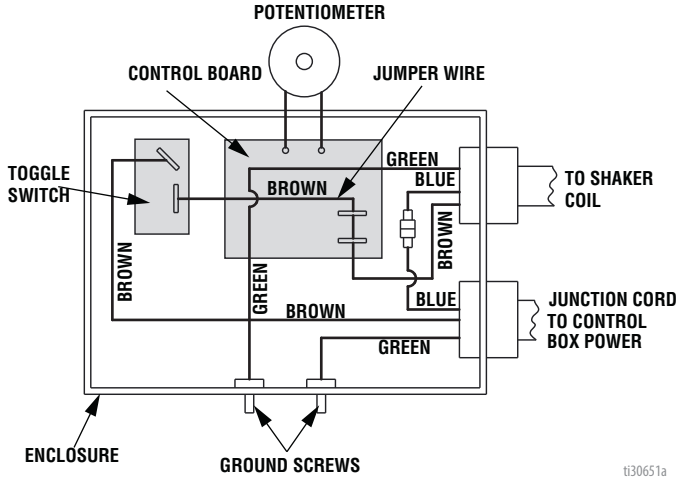

# Technical Specifications

## Technical Specifications

APX 5200		
	US	Metric
<b>Sprayer</b>		
Maximum fluid working pressure	3000 psi	20.7 MPa, 207 bar
Maximum Delivery	1.35 gpm	5.1 lpm
Maximum Tip size	0.039 in.	0.099 cm
Fluid Outlet npsm	1/2 in.	1.27 cm
Cycles	110 per gallon	29 per liter
Generator minimum	5000 W	5000 W
110-120V, Ø, A, Hz	1Ø, 20/15, 50/60	
Environmental temperature range	40°–120°F	4°–49°C
Minimum fluid temperature	40°F	4°C
<b>Dimensions</b>		
Height	42 in.	106.7 cm
Length	43 in.	109.2 cm
Width	25 in.	63.5 cm
Weight	151 lb	69 kg
<b>Noise*</b>		
Sound Power	97 dBa	97 dBa
Sound Pressure	84 dBa	84 dBa
<b>Materials of Construction</b>		
Wetted materials on all models	zinc- and nickel-plated carbon steel, nylon, stainless steel, PTFE, Acetal, leather, UHMWPE, aluminum, tungsten carbide, PEEK, brass, hard chrome	
<b>Notes</b>		
* Sound pressure measured 3 feet (1 meter) from equipment. Sound power measured per ISO-3744.		

# Technical Specifications

APX 6200		
	US	Metric
<b>Sprayer</b>		
Maximum fluid working pressure	3000 psi	20.7 MPa, 207 bar
Maximum Delivery	1.58 gpm	6.0 lpm
Maximum Tip size	0.041 in.	0.104cm
Fluid Outlet npsm	1/2 in.	1.27 cm
Cycles	97 per gallon	26 per liter
Generator minimum	5000 W	5000 W
220–240V, Ø, A, Hz	1Ø, 16, 50/60	
Environmental temperature range	40°–120°F	4°–49°C
Minimum fluid temperature	40°F	4°C
<b>Dimensions</b>		
Height	42 in.	106.7 cm
Length	43 in.	109.2 cm
Width	25 in.	63.5 cm
Weight	151 lb	69 kg
<b>Noise*</b>		
Sound Power	97 dBa	97 dBa
Sound Pressure	84 dBa	84 dBa
<b>Materials of Construction</b>		
Wetted materials on all models	zinc- and nickel-plated carbon steel, nylon, stainless steel, PTFE, Acetal, leather, UHMWPE, aluminum, tungsten carbide, PEEK, brass, hard chrome	
<b>Notes</b>		
* Sound pressure measured 3 feet (1 meter) from equipment. Sound power measured per ISO-3744.		

# Technical Specifications

APX 8200		
	US	Metric
<b>Sprayer</b>		
Maximum fluid working pressure	3000 psi	20.7 MPa, 207 bar
Maximum Delivery	2.1 gpm	8.0 lpm
Maximum Tip size	0.045 in.	0.114 cm
Fluid Outlet npsm	1/2 in.	1.27 cm
Cycles	70 per gallon	19 per liter
Generator minimum	5000 W	5000 W
220–240V, A, Hz	1Ø, 16, 50/60	
Environmental temperature range	40°–120°F	4°–49°C
Minimum fluid temperature	40°F	4°C
<b>Dimensions</b>		
Height	42 in.	106.7 cm
Length	43 in.	109.2 cm
Width	25 in.	63.5 cm
Weight	170 lb	78 kg
<b>Noise*</b>		
Sound Power	97 dBa	97 dBa
Sound Pressure	84 dBa	84 dBa
<b>Materials of Construction</b>		
Wetted materials on all models	zinc- and nickel-plated carbon steel, nylon, stainless steel, PTFE, Acetal, leather, UHMWPE, aluminum, tungsten carbide, PEEK, brass, hard chrome	
<b>Notes</b>		
* Sound pressure measured 3 feet (1 meter) from equipment. Sound power measured per ISO-3744.		

## Graco Standard Warranty

Graco warrants all equipment referenced in this document which is manufactured by Graco and bearing its name to be free from defects in material and workmanship on the date of sale to the original purchaser for use. With the exception of any special, extended, or limited warranty published by Graco, Graco will, for a period of twelve months from the date of sale, repair or replace any part of the equipment determined by Graco to be defective. This warranty applies only when the equipment is installed, operated and maintained in accordance with Graco's written recommendations.

This warranty does not cover, and Graco shall not be liable for general wear and tear, or any malfunction, damage or wear caused by faulty installation, misapplication, abrasion, corrosion, inadequate or improper maintenance, negligence, accident, tampering, or substitution of non-Graco component parts. Nor shall Graco be liable for malfunction, damage or wear caused by the incompatibility of Graco equipment with structures, accessories, equipment or materials not supplied by Graco, or the improper design, manufacture, installation, operation or maintenance of structures, accessories, equipment or materials not supplied by Graco.

This warranty is conditioned upon the prepaid return of the equipment claimed to be defective to an authorized Graco distributor for verification of the claimed defect. If the claimed defect is verified, Graco will repair or replace free of charge any defective parts. The equipment will be returned to the original purchaser transportation prepaid. If inspection of the equipment does not disclose any defect in material or workmanship, repairs will be made at a reasonable charge, which charges may include the costs of parts, labor, and transportation.

**THIS WARRANTY IS EXCLUSIVE, AND IS IN LIEU OF ANY OTHER WARRANTIES, EXPRESS OR IMPLIED, INCLUDING BUT NOT LIMITED TO WARRANTY OF MERCHANTABILITY OR WARRANTY OF FITNESS FOR A PARTICULAR PURPOSE.**

Graco's sole obligation and buyer's sole remedy for any breach of warranty shall be as set forth above. The buyer agrees that no other remedy (including, but not limited to, incidental or consequential damages for lost profits, lost sales, injury to person or property, or any other incidental or consequential loss) shall be available. Any action for breach of warranty must be brought within two (2) years of the date of sale.

**GRACO MAKES NO WARRANTY, AND DISCLAIMS ALL IMPLIED WARRANTIES OF MERCHANTABILITY AND FITNESS FOR A PARTICULAR PURPOSE, IN CONNECTION WITH ACCESSORIES, EQUIPMENT, MATERIALS OR COMPONENTS SOLD BUT NOT MANUFACTURED BY GRACO.** These items sold, but not manufactured by Graco (such as electric motors, switches, hose, etc.), are subject to the warranty, if any, of their manufacturer. Graco will provide purchaser with reasonable assistance in making any claim for breach of these warranties.

In no event will Graco be liable for indirect, incidental, special or consequential damages resulting from Graco supplying equipment hereunder, or the furnishing, performance, or use of any products or other goods sold hereto, whether due to a breach of contract, breach of warranty, the negligence of Graco, or otherwise.

### **FOR GRACO CANADA CUSTOMERS**

The Parties acknowledge that they have required that the present document, as well as all documents, notices and legal proceedings entered into, given or instituted pursuant hereto or relating directly or indirectly hereto, be drawn up in English. Les parties reconnaissent avoir convenu que la rédaction du présente document sera en Anglais, ainsi que tous documents, avis et procédures judiciaires exécutés, donnés ou intentés, à la suite de ou en rapport, directement ou indirectement, avec les procédures concernées.

# Graco Information

For the latest information about Graco products, visit [www.graco.com](http://www.graco.com).

For patent information, see [www.graco.com/patents](http://www.graco.com/patents).

**TO PLACE AN ORDER**, contact your Graco distributor or call 1-800-690-2894 to identify the nearest distributor.

*All written and visual data contained in this document reflects the latest product information available at the time of publication.*

*Graco reserves the right to make changes at any time without notice.*

Original instructions. This manual contains English. MM 3A4442

**Graco Headquarters:** Minneapolis

**International Offices:** Belgium, China, Japan, Korea

**GRACO INC. AND SUBSIDIARIES • P.O. BOX 1441 • MINNEAPOLIS MN 55440-1441 • USA**

**Copyright 2017, Graco Inc. All Graco manufacturing locations are registered to ISO 9001.**

[www.graco.com](http://www.graco.com)

Revision F, August 2021