

SaniForce™ Pail Unloader System

3A5400C
EN

For use with food grade bulk supply of medium to high viscosity product.
For professional use only.



Important Safety Instructions

Read all warnings and instructions in this manual and in manuals identified in the Related Manuals table on page 2. **Save all instructions.**

*Maximum Working Air Pressure: 100
psi (0.7 MPa, 7 bar)*
*Maximum Working Fluid Pressure: 650
psi (4.5 MPa, 45 bar)*

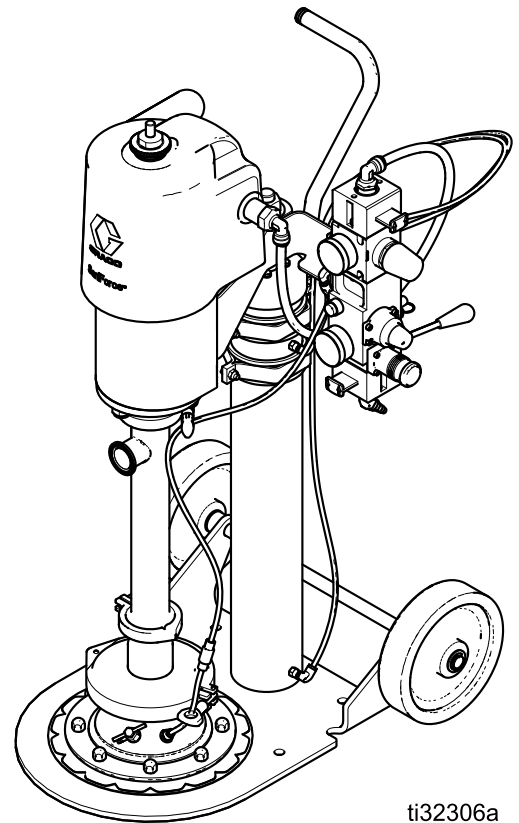





ti32306a

Contents

Models.....	2	Start and Adjust Ram	8
Related Manuals	2	Start and Adjust the Pump	8
Warnings	3	Change Pail.....	9
Configuration Matrix.....	5	Pump Shutdown	9
Installation.....	6	Maintenance	10
General Information	6	Lubrication.....	10
Locate the Pump System.....	6	Flushing and Storage	10
Grounding	7	Cleaning the Platen.....	11
Fluid Outlet Line.....	7	Dimensions	12
Operation.....	8	Technical Data	13
Pressure Relief Procedure.....	8	Graco Standard Warranty.....	14
Flush the Pump Before First Use	8		

Models

Model	Certification	Approvals
SPU.A01AAA1AA0C21	EN 10204, type 2.1	  II 2 GD Ex h IIA T4 Gb X Ex h IIIA 100°C Db X
SPU.A01AAA1AA0C31	EN 10204, type 3.1	
SPU.A01AAB1AA0C21	EN 10204, type 2.1	  II 2 GD Ex h IIA T4 Gb X Ex h IIIA 100°C Db X
SPU.A01AAB1AA0C31	EN 10204, type 3.1	











EC 1935/2004







Related Manuals

Manual Number	Title
3A5564	SaniForce 6:1 Sanitary Pumps, Instructions and Parts
3A5401	SaniForce Pail Unloader System, Parts
3A5800	SaniForce Air Controls, Instructions/Parts

Warnings

The following warnings are for the setup, use, grounding, maintenance, and repair of this equipment. The exclamation point symbol alerts you to a general warning and the hazard symbols refer to procedure-specific risks. When these symbols appear in the body of this manual or on warning labels, refer back to these Warnings. Product-specific hazard symbols and warnings not covered in this section may appear throughout the body of this manual where applicable.

 <h1 style="margin: 0;">WARNING</h1>	
   	<p>FIRE AND EXPLOSION HAZARD</p> <p>Flammable fumes, such as solvent and paint fumes, in work area can ignite or explode. Paint or solvent flowing through the equipment can cause static sparking. To help prevent fire and explosion:</p> <ul style="list-style-type: none"> • Use equipment only in well ventilated area. • Eliminate all ignition sources; such as pilot lights, cigarettes, portable electric lamps, and plastic drop cloths (potential static sparking). • Ground all equipment in the work area. See Grounding instructions. • Keep work area free of debris, including solvent, rags and gasoline. • Do not plug or unplug power cords, or turn power or light switches on or off when flammable fumes are present. • Use only grounded hoses. • Stop operation immediately if static sparking occurs or you feel a shock. Do not use equipment until you identify and correct the problem. • Keep a working fire extinguisher in the work area.
 	<p>SPECIAL CONDITIONS FOR SAFE USE</p> <p>Equipment must comply with the following conditions to avoid hazardous condition which can cause fire or explosion:</p> <ul style="list-style-type: none"> • Clean plastic parts only in well ventilated area. • Do not clean with a dry cloth.
  	<p>PRESSURIZED EQUIPMENT HAZARD</p> <p>Fluid from the equipment, leaks, or ruptured components can splash in the eyes or on skin and cause serious injury.</p> <ul style="list-style-type: none"> • Follow the Pressure Relief Procedure when you stop spraying/dispensing and before cleaning, checking, or servicing equipment. • Tighten all fluid connections before operating the equipment. • Check hoses, tubes, and couplings daily. Replace worn or damaged parts immediately.

 <h1 style="margin: 0;">WARNING</h1>	
 	<p>MOVING PARTS HAZARD</p> <p>Moving parts can pinch or amputate fingers and other body parts.</p> <ul style="list-style-type: none"> • Keep clear of moving parts. • Do not operate equipment with protective guards or covers removed. • Pressurized equipment can start without warning. Before checking, moving, or servicing equipment, follow the Pressure Relief Procedure and disconnect all power sources.
	<p>SPLATTER HAZARD</p> <p>During blow off of platen, splatter may occur.</p> <ul style="list-style-type: none"> • Use minimum air pressure when removing platen from container.
 	<p>EQUIPMENT MISUSE HAZARD</p> <p>Misuse can cause death or serious injury.</p> <ul style="list-style-type: none"> • Do not operate the unit when fatigued or under the influence of drugs or alcohol. • Do not exceed the maximum working pressure or temperature rating of the lowest rated system component. See Technical Data in all equipment manuals. • Use fluids and solvents that are compatible with equipment wetted parts. See Technical Data in all equipment manuals. Read fluid and solvent manufacturer's warnings. For complete information about your material, request Safety Data Sheet (SDS) from distributor or retailer. • Turn off all equipment and follow the Pressure Relief Procedure when equipment is not in use. • Check equipment daily. Repair or replace worn or damaged parts immediately with genuine manufacturer's replacement parts only. • Do not alter or modify equipment. Alterations or modifications may void agency approvals and create safety hazards. • Make sure all equipment is rated and approved for the environment in which you are using it. • Use equipment only for its intended purpose. Call your distributor for information. • Route hoses and cables away from traffic areas, sharp edges, moving parts, and hot surfaces. • Do not kink or over bend hoses or use hoses to pull equipment. • Keep children and animals away from work area. • Comply with all applicable safety regulations.
	<p>PERSONAL PROTECTIVE EQUIPMENT</p> <p>Wear appropriate protective equipment when in the work area to help prevent serious injury, including eye injury, hearing loss, inhalation of toxic fumes, and burns. Protective equipment includes but is not limited to:</p> <ul style="list-style-type: none"> • Protective eyewear, and hearing protection. • Respirators, protective clothing, and gloves as recommended by the fluid and solvent manufacturer.

Configuration Matrix

Check the identification plate (ID) for the Configuration Number of your pump. Use the

following matrix to define the components of your system.

Sample Configuration Number: **SPU A01AAA1AA0C21**

SPU	A	01	A	A	A	1	AA	0	C21
Sanitary Pail Unloader	Frame	Pump	Platen	Seal Style	Seal Material	Controls	Accessories	Wash Bin	Certification

NOTE: Some combinations are not possible. Please check with your local supplier.

Sanitary Pail Unloader	Frame		Pump		Platen		Seal Style	
SPU	A	Stainless Steel	01	6:1 Priming Piston	A	5-7 gallon plastic pail	A	Static

Seal Material		Controls		Accessories		Wash Bin		Certification	
A*	PTFE	1	Exposed pneumatic	AA	Mobile	0	None	C21	EN 10204 type 2.1
B	Buna-N							C31	EN 10204 type 3.1

* Only recommended where required for chemical compatibility.

Installation

General Information

The Typical Installation shown is only a guide for selecting and installing system components.

Reference letters in the text, for example (A), refer to the callouts in the figures.

The Pail Unloader System consists of parts which are stationary and parts attached to the air cylinder piston rod. The parts, such as the pump and the control assembly, attached to the air cylinder center shaft will raise and lower (move) during normal operation. These moving parts comprise the ram.

Locate the Pump System

1. Position the pump system so the air controls are easily accessible. Ensure that there is enough space overhead for the ram to raise fully. (See [Dimensions, page 12](#))
2. Make sure the surface is flat and that the unit doesn't wobble.

NOTE: If the unit is being located in a permanent location, use the four holes in the baseplate as a guide to locate where to drill holes for mounting anchors.

3. For ease of operation and service, locate the pump so fluid outlet port is easily accessible.

NOTE: The outlet can be rotated to accommodate the location.

NOTE: An area should be left clear around the unit to ensure safe access for maintenance.

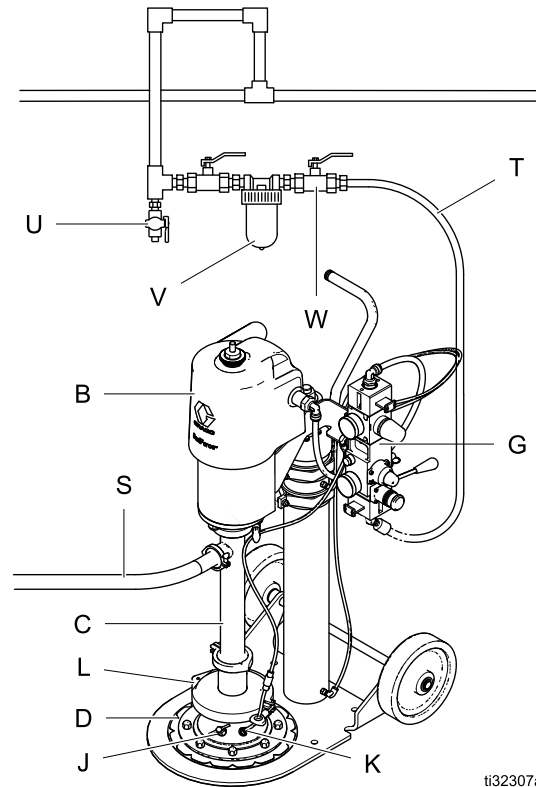

System Components

B	Air Motor
C	Displacement Pump
D	Platen
G	Integrated Air Control
J	Platen Bleed Port
K	Blowoff Port
L	Platen to pump lower clamp

Required Accessories/Components Not Supplied

S	Fluid Line
T	Air Supply Line
U	Air Line Drain Valve
V	Air Filter
W	Bleed Type Air Shutoff Valve

Fig. 1 Typical installation

Integrated Air Control

The integrated air control includes:

- **Source air supply (A1):** facility air supply to power SPU.
- **Air motor drive air (A2):** air supply to drive pump air motor.
- **Main air slider valve (BA):** turns air on and off to the system. When closed, the valve relieves pressure downstream.
- **Ram air regulator (BB):** controls ram up and down pressure and blowoff pressure.
- **Ram air pressure gauge (BC):** displays the air pressure used to raise and lower the ram.
- **Ram director valve (BD):** controls ram direction.
- **Air motor regulator (BE):** controls air pressure to motor.
- **Air motor pressure gauge (BF):** displays the air pressure used to drive the air motor.
- **Blowoff button (BG):** turns air on and off to push the platen out of an empty pail.
- **Air motor slider valve (BH):** turns air on and off to the air motor. When closed, the valve relieves air trapped between it and the air motor. Push the valve in to shutoff.

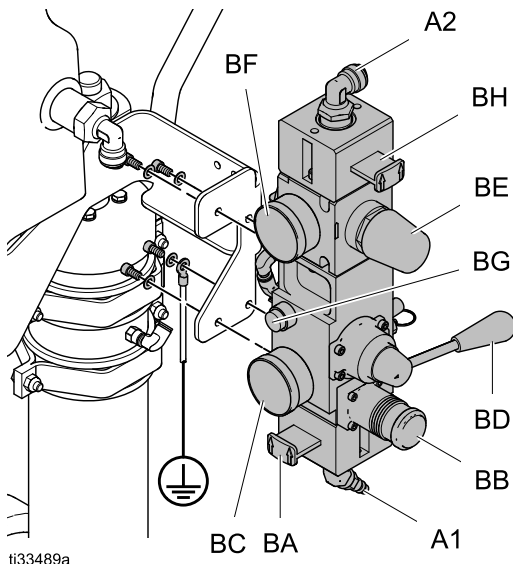

Air Line Accessories

See Fig. 1.

- **Air line drain valve (U)**
- **Air line filter (V):** removes harmful dirt and moisture from compressed air supply.

- **Second bleed-type air valve (W):** isolates air line accessories and supply system for servicing. Locate upstream from all other air line accessories.
- **Air relief valve (100 psi):** (two attached to ram integrated air controls for pump and ram air, not visible): automatically relieves excessive pressure.

Grounding

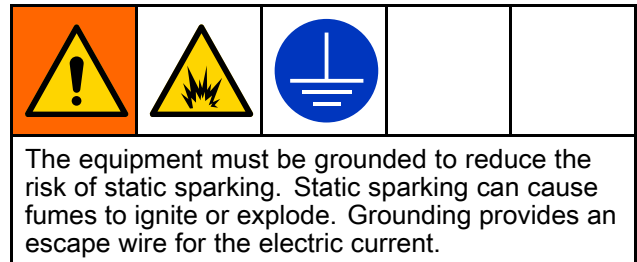

Before operating the pump, ground the system as explained below.

- **Pump:** Connect the grounding wire attached to the bracket to a true earth ground.
- **Air and fluid hoses:** Use only grounded hoses with a maximum of 500 ft (150 m) combined hose length to ensure grounding continuity. Check electrical resistance of hoses. If total resistance to ground exceeds 29 megohms, replace hose immediately.
- **Spray gun/dispense valve:** ground through connection to a properly grounded fluid hose and pump.
- **Fluid supply container:** Follow local code.
- **Solvent pails used when flushing:** Follow local code. Use only conductive metal pails, placed on a grounded surface. Do not place the pail on a nonconductive surface, such as paper or cardboard, which interrupts grounding continuity.

Check your system electrical continuity between the ground wire end and the pump fluid outlet after the initial installation, and then set up a regular schedule for checking continuity to be sure proper grounding is maintained. The resistance should not exceed 10 ohms. Ground cable 244524 is available separately.

Fluid Outlet Line

Connect a grounded, flexible fluid hose (S) to the fluid outlet port. The port is a 1.5 in (38 mm) sanitary flange.

Operation

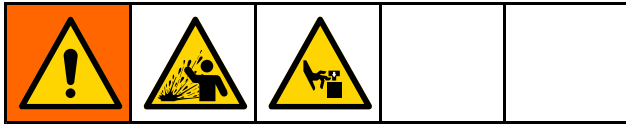

Pressure Relief Procedure



Follow the Pressure Relief Procedure whenever you see this symbol.

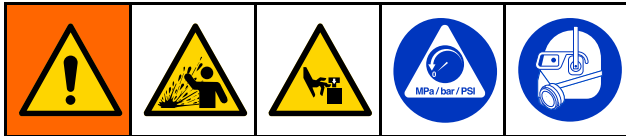

This equipment stays pressurized until pressure is relieved manually. To help prevent serious injury from moving parts, or from pressurized fluid, such as splashing in the eyes or on skin, follow the Pressure Relief Procedure when you stop pumping and before you clean, check, or service the equipment.

1. Close the air motor slider valve (BH) and the main air slider valve (BA).
NOTE: Both are relieving air valves.
2. Set the ram director valve (BD) to DOWN. The ram will slowly drop.
3. Jog the ram director valve (BD) up and down to bleed air from ram cylinder.
4. Open dispense valve or trigger gun to relieve pump output pressure.

Flush the Pump Before First Use

The pump was tested in water. If water could contaminate the fluid you are pumping, flush the pump thoroughly with a compatible solvent. See pump manual for detailed cleaning instructions.

Start and Adjust Ram

1. Raise the ram:
 - a. Open the main air slider valve (BA) and set the ram air regulator (BB) to 30 psi (0.21 MPa, 2.1 bar).
 - b. Move the ram director valve (BD) handle to UP. Allow the ram to rise to full height.
 - c. When the ram is at its full height, move the ram director valve (BD) handle to the neutral (center) position.

2. Place a full pail on the base and center it under the Platen (D).
3. Adjust the pail to be sure it is aligned with the platen, and open the platen bleed port (J).

NOTE: If the platen is not aligned properly for entering the pail, when the platen reaches the top of the pail, move the ram director valve (BD) handle to the neutral position and move the pail. Then continue lowering the platen into the pail.

4. With hands away from the pail and the platen, move the ram director valve (BD) handle to DOWN, and lower the ram until the platen lowers into the pail and fluid begins to come out of the platen bleed port (J).
5. Move the ram director valve (BD) handle to the neutral position.
6. Close the platen bleed port (J).

Start and Adjust the Pump

1. Connect pump outlet fittings and hose (not supplied).
NOTE: Be sure all components are adequately sized and pressure rated to meet the system's requirements.
2. Be sure the pump air valve (BE) is closed. Set the pump air regulator (BB) to about 30 psi (0.21 MPa, 2.1 bar). Set the ram director valve (BD) handle to DOWN. See manual 3A5800 for SaniForce air controls instructions and parts.
3. Open the pump air motor slider valve (BH).
4. Keep the ram director valve (BD) handle DOWN while pump is operating.

NOTE: Increase air pressure to the ram if the pump does not prime properly with heavier fluids. Decrease air pressure if fluid is forced out around the top seal or platen.

Change Pail

1. Turn off pump air supply by pushing the air motor slider valve (BH) to the off position.
2. Raise the platen out of the pail:

NOTE: When raising the ram, the pail must be pushed off of the platen by use of the blowoff button (BG). When the blowoff button (BG) is pushed, the air supply raising the ram is diverted to the blowoff connection on the platen and creates a pressure to push the pail off of the platen. If the ram director valve (BD) is not in the up (raise ram) position, the blowoff button (BG) has no functionality.

- a. Move the director valve handle (BD) to the UP position.
 - b. As the ram raises the pail off of the base, periodically press the blowoff button (BG) to create a pressure in the pail to push it off of the platen.
 - c. When the platen is free of the pail and the ram reaches its full height, move the director valve handle (BD) to the neutral position.
3. Remove the empty pail.

4. Inspect platen and, if necessary, remove any remaining material or material build-up. If full cleaning is necessary, see [Cleaning the Platen, page 11](#).
5. To empty another pail, perform the steps of [Start and Adjust Ram, page 8](#).

Pump Shutdown

At the end of the work shift, after any necessary flushing, and before you check, clean, adjust, or repair the system, follow the [Pressure Relief Procedure, page 8](#). Always stop the pump at the bottom of its stroke to prevent fluid from drying on the displacement rod. (The air motor will exhaust at the bottom or top of the stroke.)

Turn off the air supply shutoff valve (W).

NOTICE

To prevent leakage or damage to the wiper, ensure the platen is removed from the pail when the system is not operating.

Maintenance

Lubrication

The pump is lubricated at the factory. It is designed to require no further lubrication for the life of the packings. There is no need to add an inline lubricator under normal operating conditions.

Flushing and Storage

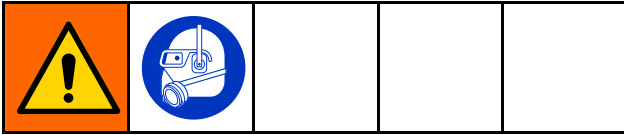

- Flush before fluid can dry in the equipment, at the end of the day, before storing, and before disassembling or repairing equipment.
- Flush at the lowest pressure possible. Check connectors for leaks and tighten as necessary.

- Flush with a fluid that is compatible with the fluid being dispensed and the equipment wetted parts.
- Always flush the pump and relieve the pressure before storing it for any length of time.



NOTICE

Flush the pump often enough to prevent the fluid you are pumping from drying or freezing in the pump and damaging it. Store the pump at 32°F (0°C) or higher. Exposure to extreme low temperatures may result in damage to plastic parts.

NOTICE

To prevent leakage or damage to the wiper, ensure the platen is removed from the pail when the system is not operating.

Cleaning the Platen

				
<p>This equipment stays pressurized during the removal of the platen from the pump. To help prevent serious injury from moving parts while you remove the platen for cleaning, keep fingers above the platen. Do not attempt to grab the platen at the edges while it is above the baseplate.</p>				

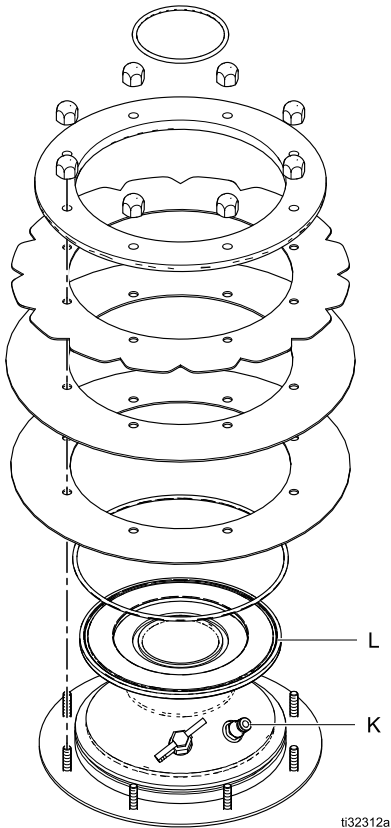

PTFE platen shown

When done using the pail unloader system for the day, or when cleaning is needed so that a different product can be pumped, perform the following:

1. Remove the pail. See [Change Pail, page 9](#).
2. Lower the ram so that the platen is resting flat against the baseplate.
3. Disconnect the blowoff air hose at the blowoff port (K).
4. Remove the clamp at the large flange (L) connection where the platen attaches to the pump lower.
5. If the platen doesn't independently separate from the pump, use the air controls to slightly raise the platen off the baseplate. Then, using open hands on opposite sides of the platen, apply downward hand pressure to break the seal. When the platen is loose from the pump lower unit, continue raising the ram until the lower unit clears the platen. Move the ram director valve (BD) handle to neutral to stop raising the ram.
6. Slide the platen out from under the pump lower and lower the ram as far as possible.
7. If more than flushing of the pump is necessary, follow the steps in the pump manual for cleaning the pump lower unit.
8. Clean the platen:
 - a. Refer to the drawing at left for items of the platen assembly.
 - b. Remove the cap nuts and disassemble the platen assembly.
 - c. Use a solvent compatible with the product being unloaded and the materials of platen construction.
 - d. Reassemble the platen assembly. Tighten the cap nuts hand tight, then torque to 40–50 in-lb in a crisscross pattern.
 - e. Raise the ram and locate the platen under the pump lower. Move fingers and tools out of the way and slowly lower the pump into the platen.
9. If necessary, remove the lower unit of the pump and disassemble for cleaning as specified in the pump manual.
10. Attach the platen to the pump lower at the flange (L) and re-attach the blowoff hose to the blowoff port (K) on the platen, routing the hose through the sanitary clamp handle eyelets.

Dimensions

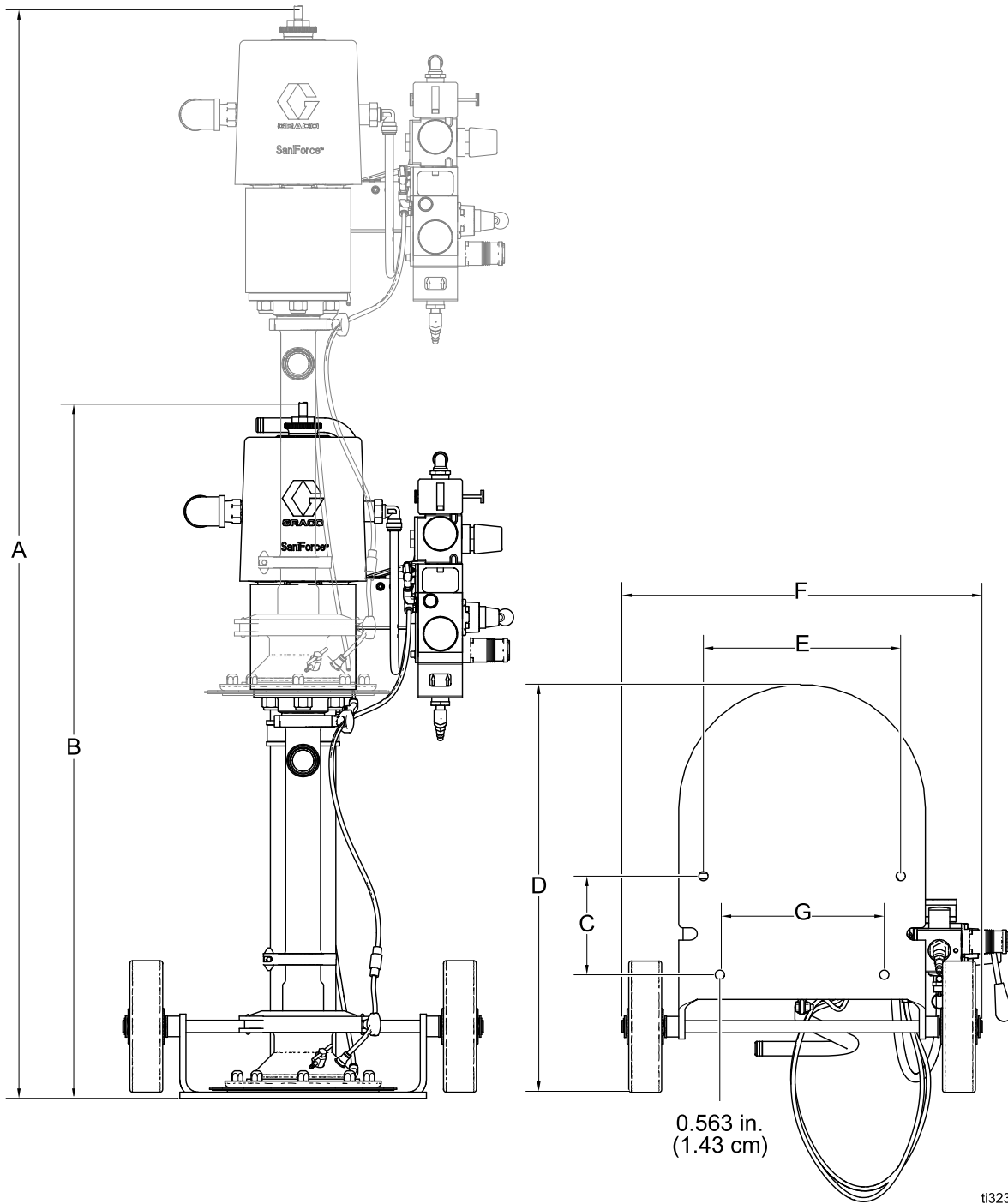

t132309a

A In. (mm)	B In. (mm)	C In. (mm)	D In. (mm)	E In. (mm)	F In. (mm)	G In. (mm)
62.82 (1596)	42.34 (1075)	6.0 (152)	24.82 (630)	12.0 (305)	22.0 (559)	10.0 (254)

Technical Data

Sanitary Pail Unloader		
	US	Metric
Maximum fluid working pressure	650 psi	4.5 MPa, 44.8 bar
Maximum air inlet pressure	100 psi	0.7 MPa, 6.9 bar
Air consumption	See pump manual	
Maximum recommended pump speed	60 cycles/min, 4 gpm (15 liters/min) delivery	
Maximum ambient temperature (air motor)	90° F	32° C
Maximum fluid temperature†	120° F	49° C
Fluid Outlet Size		
Stainless Steel	1.5 in. Sanitary Flange	
Weight		
Stainless Steel	approximately. 160 lb	approximately 72.6 kg
Wetted Parts (See pump manual for pump wetted parts)		
316 Stainless Steel, Polyethylene, Nitrile, PTFE.		
Sound data		
Sound power*	78.5 dBa	
Sound pressure**	71.6 dBa	

* Sound power at 70 psi (0.48 MPa, 4.8 bar), 20 cpm. Sound power measured per ISO-9614-2.

** Sound pressure was tested 3.28 feet (1 m) from equipment.

Graco Standard Warranty

Graco warrants all equipment referenced in this document which is manufactured by Graco and bearing its name to be free from defects in material and workmanship on the date of sale to the original purchaser for use. With the exception of any special, extended, or limited warranty published by Graco, Graco will, for a period of twelve months from the date of sale, repair or replace any part of the equipment determined by Graco to be defective. This warranty applies only when the equipment is installed, operated and maintained in accordance with Graco's written recommendations.

This warranty does not cover, and Graco shall not be liable for general wear and tear, or any malfunction, damage or wear caused by faulty installation, misapplication, abrasion, corrosion, inadequate or improper maintenance, negligence, accident, tampering, or substitution of non-Graco component parts. Nor shall Graco be liable for malfunction, damage or wear caused by the incompatibility of Graco equipment with structures, accessories, equipment or materials not supplied by Graco, or the improper design, manufacture, installation, operation or maintenance of structures, accessories, equipment or materials not supplied by Graco.

This warranty is conditioned upon the prepaid return of the equipment claimed to be defective to an authorized Graco distributor for verification of the claimed defect. If the claimed defect is verified, Graco will repair or replace free of charge any defective parts. The equipment will be returned to the original purchaser transportation prepaid. If inspection of the equipment does not disclose any defect in material or workmanship, repairs will be made at a reasonable charge, which charges may include the costs of parts, labor, and transportation.

THIS WARRANTY IS EXCLUSIVE, AND IS IN LIEU OF ANY OTHER WARRANTIES, EXPRESS OR IMPLIED, INCLUDING BUT NOT LIMITED TO WARRANTY OF MERCHANTABILITY OR WARRANTY OF FITNESS FOR A PARTICULAR PURPOSE.

Graco's sole obligation and buyer's sole remedy for any breach of warranty shall be as set forth above. The buyer agrees that no other remedy (including, but not limited to, incidental or consequential damages for lost profits, lost sales, injury to person or property, or any other incidental or consequential loss) shall be available. Any action for breach of warranty must be brought within two (2) years of the date of sale.

GRACO MAKES NO WARRANTY, AND DISCLAIMS ALL IMPLIED WARRANTIES OF MERCHANTABILITY AND FITNESS FOR A PARTICULAR PURPOSE, IN CONNECTION WITH ACCESSORIES, EQUIPMENT, MATERIALS OR COMPONENTS SOLD BUT NOT MANUFACTURED BY GRACO. These items sold, but not manufactured by Graco (such as electric motors, switches, hose, etc.), are subject to the warranty, if any, of their manufacturer. Graco will provide purchaser with reasonable assistance in making any claim for breach of these warranties.

In no event will Graco be liable for indirect, incidental, special or consequential damages resulting from Graco supplying equipment hereunder, or the furnishing, performance, or use of any products or other goods sold hereto, whether due to a breach of contract, breach of warranty, the negligence of Graco, or otherwise.

FOR GRACO CANADA CUSTOMERS

The Parties acknowledge that they have required that the present document, as well as all documents, notices and legal proceedings entered into, given or instituted pursuant hereto or relating directly or indirectly hereto, be drawn up in English. Les parties reconnaissent avoir convenu que la rédaction du présente document sera en Anglais, ainsi que tous documents, avis et procédures judiciaires exécutés, donnés ou intentés, à la suite de ou en rapport, directement ou indirectement, avec les procédures concernées.

Graco Information

For the latest information about Graco products, visit www.graco.com.
For patent information, see www.graco.com/patents.

To place an order, contact your Graco Distributor or call to identify the nearest distributor.

Phone: 612-623-6921 **or Toll Free:** 1-800-328-0211 **Fax:** 612-378-3505

All written and visual data contained in this document reflects the latest product information available at the time of publication.

Graco reserves the right to make changes at any time without notice.

Original Instructions. This manual contains English. MM 3A5400

Graco Headquarters: Minneapolis

International Offices: Belgium, China, Japan, Korea

GRACO INC. AND SUBSIDIARIES • P.O. BOX 1441 • MINNEAPOLIS MN 55440-1441 • USA
Copyright 2018, Graco Inc. All Graco manufacturing locations are registered to ISO 9001.

www.graco.com
Revision C, August 2021