

Operation, Repair, Parts



SaniSpray HP™ 130 Cart Airless Sprayer

3A7656E

EN

For portable spraying of water-based disinfectants approved for spray application only. Not for applying architectural paints and coatings. Not approved for use in explosive atmospheres or hazardous (classified) locations. For professional use only.







Important Safety Instructions

Read all warnings and instructions in this manual, in related manuals, and on the unit before using the equipment. Be familiar with the controls and the proper usage of the equipment. Save these instructions.



Important Medical Information

Read the medical alert card provided with the sprayer. It contains injection injury treatment information for a doctor. Keep it with you when operating the equipment.

 WARNING	
   	<p>CHEMICAL HAZARD To prevent serious injury:</p> <ul style="list-style-type: none">• Follow all directions and requirements on disinfectant label. It is a violation of Federal law to use an EPA-approved disinfectant in a manner inconsistent with its labeling.• Flush after each use. Never store disinfectant in equipment.• Use only with appropriate personal protective equipment.

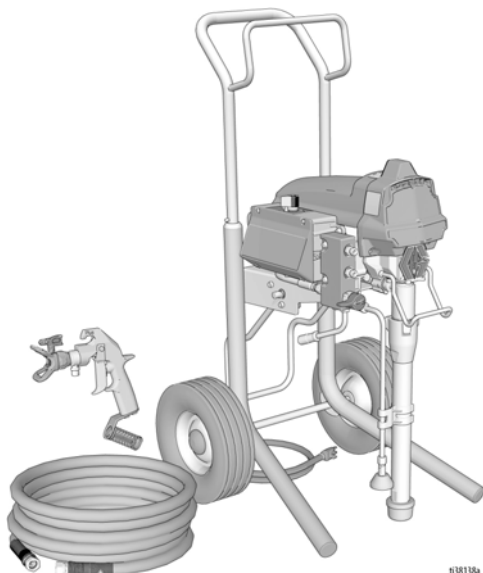

938138a

 SERVICE <small>to every customer, every time</small>	 ??  ?? www.graco.com/techsupport	
---	--	---



*Use only genuine Graco replacement parts.
The use of non-Graco replacement parts may void warranty.*

PROVEN QUALITY. LEADING TECHNOLOGY.

Contents

Models	3
Important User Information	4
Warnings	5
Know Your Sprayer	9
Grounding	10
Power Requirements	10
Extension Cords	10
Pails	10
Setup	11
Start Up	12
Pressure Relief Procedure	12
Flushing a New Sprayer	14
Fill Pump	15
Fill Spray Gun and Airless Hose	16
How to Spray	17
Choose Your Spray Tip	17
Spray Tip Orientation	18
Starting Your Spray and Adjusting Pressure	18
Clear Tip Clog	19
Cleanup	20
Clean the Gun	23
Storage	23
Maintenance	24
Recycling and Disposal	25
End of Product Life	25
Troubleshooting	26
Mechanical/Fluid Flow	26
Electrical	29
Parts - SaniSpray HP 130 (Quick Repair)	34
Parts - SaniSpray HP 130 (Extended Repair)	36
Wiring Diagrams	38
120V	38
110V UK & 220-240V	39
Technical Specifications	40
California Proposition 65	41
Graco Warranty	42
Graco Information	43

Models

	VAC	Model
 Intertek 110474 Certified to CAN/CSA C22.2 No. 68 Conforms to UL 1450	120V USA	25R793
	230V Europe Multi	25R947
	110V UK	25R951
	240 APV Multi	25R955
	100V JP/TW	25T301

Maximum Working Pressure: 1000 psi (6.9 MPa, 69 bar)

Important User Information

Important User Information



Before using your disinfectant sprayer, read this manual for complete instructions on proper use and safety warnings.



You must also read and follow the information on the disinfectant container label and ask for a Safety Data Sheet (SDS) from your supplier. The container label and SDS will explain the contents of the material, instructions for use and the specific precautions related to the contents of the material. Those precautions include personal protective equipment (PPE).



The sprayer is designed to spray disinfectants that are water-based and clean up with water.



KNOW YOUR DISINFECTANT'S ACTIVE INGREDIENTS

For the purpose of safely using this sprayer, you need to know what kind of **active ingredients** are in the disinfectant. Look on the container label for the list of active ingredients. There are two categories:



ALCOHOL: This type of disinfectant contains flammable active ingredients such as ethanol (ethyl alcohol) or isopropanol (IPA). The container label should indicate that this material is **COMBUSTIBLE** or **FLAMMABLE**. Your sprayer is compatible with this type of material. Use flammable materials in a well-ventilated area with a flow of fresh air. See the safety warnings in this manual.



NON-ALCOHOL: This type of disinfectant contains active ingredients such as aldehydes, phenols, quaternary ammonium compounds, sodium hypochlorite (bleach), peroxyacetic acid, hydrogen peroxide, and hypochlorous acid. Your sprayer is compatible with this type of material.

Warnings

The following warnings are for the setup, use, grounding, maintenance, and repair of this equipment. The exclamation point symbol alerts you to a general warning and the hazard symbols refer to procedure-specific risks. When these symbols appear in the body of this manual or on warning labels, refer back to these Warnings. Product-specific hazard symbols and warnings not covered in this section may appear throughout the body of this manual where applicable.

WARNING



CHEMICAL HAZARD

Toxic disinfectant or fumes can cause serious injury or death if splashed in the eyes or on skin, inhaled, or swallowed.



- Keep away from children.
- Use only to spray surfaces. Do not spray humans or animals.
- Use only with appropriate personal protective equipment. See **PERSONAL PROTECTIVE EQUIPMENT**, page 7.
- Follow all directions and requirements on disinfectant label. It is a violation of Federal law to use an EPA-approved disinfectant in a manner inconsistent with its labeling.
- Flush with water after each use. Never store disinfectant in equipment.
- Read Safety Data Sheets (SDSs) to know the specific hazards of the disinfectants you are using.
- Store and dispose of disinfectants according to instructions on disinfectant container labels.



SKIN INJECTION HAZARD

High-pressure spray is able to inject toxins into the body and cause serious bodily injury that can result in amputation. In the event that injection occurs, **get immediate surgical treatment**.



- Use only to spray surfaces. Do not spray humans or animals.
- Do not point spray tip at anyone or place any part of your body in front of tip. For example, do not try to stop leaks with any part of the body.
- Always use the spray tip guard. Do not spray without spray tip guard in place. Use only Graco spray tips.
- Use caution when cleaning and changing spray tips. In the case where the spray tip clogs while spraying, follow the **Pressure Relief Procedure**, page 12, for relieving the pressure before removing the spray tip to clean.
- Equipment maintains pressure after power is shut off. Do not leave the equipment energized or under pressure while unattended. Unplug the sprayer and follow the **Pressure Relief Procedure**, page 12, when the equipment is unattended or not in use, and before servicing, cleaning, or removing parts.
- Check hoses and parts for signs of damage. Replace any damaged hoses or parts.
- This system is capable of producing 1000 psi (69 bar, 6.9 MPa). Use Graco parts or accessories that are rated a minimum of 1000 psi (69 bar, 6.9MPa).
- Always engage the trigger lock when not spraying. Verify the trigger lock is functioning properly.
- Verify that all connections are secure before operating the unit.
- Know how to stop the unit and bleed pressure quickly. Be thoroughly familiar with the controls.

WARNING



FIRE AND EXPLOSION HAZARD

Flammable fumes, such as disinfectants, in work area can ignite or explode. To help prevent fire and explosion:



- Do not spray flammable disinfectants near an open flame or sources of ignition such as cigarettes, motors, and electrical equipment.



- Disinfectants flowing through the equipment are able to result in static electricity. Static electricity creates a risk of fire or explosion in the presence of disinfectant fumes. All parts of the spray system, including the pump, hose assembly, spray gun, and objects in and around the spray area shall be properly grounded to protect against static discharge and sparks. Use Graco conductive or grounded high-pressure airless sprayer hoses.



- Verify that all containers and collection systems are grounded to prevent static discharge. Do not use pail liners unless they are anti-static or conductive.
- Connect to a grounded outlet and use grounded extensions cords. Do not use a 3-to-2 adapter.
- Keep spray area well-ventilated. Keep a good supply of fresh air moving through the area.
- Sprayer generates sparks. Keep pump assembly in a well ventilated area a least 20 feet (6.1 m) from the spray area when spraying, flushing, cleaning, or servicing. Do not spray pump assembly.
- Do not smoke in the spray area or spray where sparks or flame is present.
- Do not operate light switches, engines, or similar spark producing products in the spray area.
- Keep area clean and free of disinfectant containers, rags, and other flammable materials.
- Know the contents of the disinfectants being sprayed. Read all Safety Data Sheet (SDS) and container labels provided with the disinfectants. Follow the disinfectant manufacturer's safety instructions.
- Keep a working fire extinguisher in the work area.



EQUIPMENT MISUSE HAZARD

Misuse can cause death or serious injury.



- Do not operate or spray near children. Keep children away from equipment at all times.
- Do not overreach or stand on an unstable support. Keep effective footing and balance at all times.
- Stay alert and watch what you are doing.
- Do not operate the unit when fatigued or under the influence of drugs or alcohol.
- Do not kink or over-bend the hose.
- Do not expose the hose to temperatures or to pressures in excess of those specified by Graco.
- Do not use the hose as a strength member to pull or lift the equipment.
- Do not spray with a hose shorter than 25 feet.
- Do not alter or modify equipment. Alterations or modifications may void agency approvals and create safety hazards.
- Make sure all equipment is rated and approved for the environment in which you are using it.

WARNING



ELECTRIC SHOCK HAZARD

This equipment must be grounded. Improper grounding, setup, or usage of the system can cause electric shock.



- Turn off and disconnect power cord before servicing equipment.
- Connect only to grounded electrical outlets.
- Use only 3-wire extension cords.
- Ensure ground prongs are intact on power and extension cords.
- Do not get wet or expose to rain. Store indoors.
- Wait five minutes after disconnecting power cord before servicing.



MOVING PARTS HAZARD

Moving parts can pinch, cut, or amputate fingers and other body parts.



- Keep clear of moving parts.
- Do not operate equipment with protective guards or covers removed.
- Pressurized equipment can start without warning. Before checking, moving, or servicing equipment, follow the **Pressure Relief Procedure** and disconnect all power sources.



PERSONAL PROTECTIVE EQUIPMENT

Wear appropriate protective equipment when in the work area to help prevent serious injury, including eye injury, burns, hearing loss, and inhalation of disinfectant chemical mists and vapors. Protective equipment includes but is not limited to:

- Protective eye-wear, and hearing protection.
- Appropriate respirators, protective clothing, and gloves.
- All protective equipment specified by the disinfectant manufacturer.

WARNING



GROUNDING

This product must be grounded. In the event of an electrical short circuit, grounding reduces the risk of electric shock by providing an escape wire for the electric current. This product is equipped with a cord having a grounding wire with an appropriate grounding plug. The plug must be plugged into an outlet that is properly installed and grounded in accordance with all local codes and regulations.

- Improper installation of the grounding plug is able to result in a risk of electric shock.
- This product is for use on a nominal 120V or 230V circuit and has a grounding plug similar to the plug illustrated below.

120 V

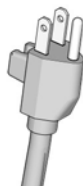

230 V



230 V ANZ



230 V India

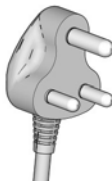

ti24583c

- Only connect the product to an outlet having the same configuration as the plug.
- Do not modify the plug provided; if it does not fit the outlet, have the proper outlet installed by a qualified electrician.
- Do not use an adapter with this product.
- When repair or replacement of the cord or plug is required, do not connect the grounding wire to either power terminal.
- The wire with insulation having an outer surface that is green with or without yellow stripes is the grounding wire.
- Check with a qualified electrician or serviceman when the grounding instructions are not completely understood, or when in doubt as to whether the product is properly grounded.

Extension Cords:

- Use only a 3-wire extension cord that has a grounding plug and a grounding receptacle that accepts the plug on the product.
- When using the sprayer outdoors, use an extension cord suitable for outdoor use.
- Make sure your extension cord is not damaged.
- When using an extension cord, be sure to use a cord heavy enough to carry the current that your sprayer draws. An undersized cord results in a drop in line voltage and loss of power and overheating. When in doubt use the next heavier gauge. The smaller the gauge number the heavier the cord. See chart for appropriate sizes and lengths:

Conductor Size		Length
AWG (American Wire Gauge)	Metric	Maximum
16	1.5 mm ²	25 ft. (8 m)
12	2.5 mm ²	50 ft. (15 m)

Know Your Sprayer

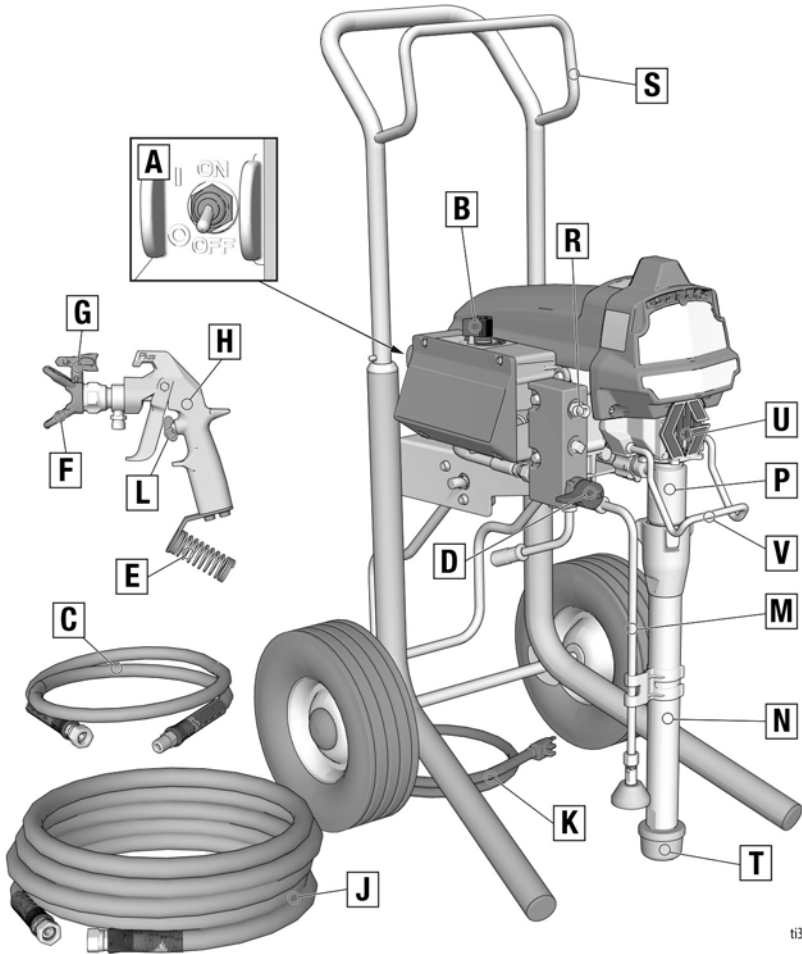





ti38139a

A	ON/OFF Switch
B	Pressure Control Knob
C	Airless Whip Hose
D	Prime/Spray Valve
E	Hose Guard
F	Spray Tip Guard
G	Spray Tip
H	SaniSpray HP Airless Spray Gun
J	Airless Hose
K	Power Cord

L	Trigger Lock
M	Drain Tube
N	Suction Tube
P	Pump
R	Fluid Outlet Fitting
S	Hanger
T	Inlet Strainer
U	Finger Guard
V	Pail Hook
	Model/Serial Tag, bottom of unit (not shown)

Grounding

Grounding

				
<p>The equipment must be grounded to reduce the risk of static sparking and electric shock. An electric or static spark can cause fumes to ignite or explode. An improper ground can cause electric shock. A good ground provides an escape wire for the electric current.</p>				

This sprayer is equipped with a Power Cord that has a ground wire and an appropriate grounding plug.

The plug must be plugged into an outlet that is properly installed and grounded in accordance with all local codes and ordinances.

Do not modify the plug provided; if it does not fit the outlet, have the proper outlet installed by a qualified electrician.

Power Requirements

- 100-120V units require 100-120 VAC, 50/60 Hz, 15A, 1 phase.
- 230V units require 220-240 VAC, 50/60 Hz, 9A, 1 phase.

Extension Cords

Use an extension cord with an undamaged ground contact. If an extension cord is necessary, use a 3-wire, 12 AWG (2.5mm²) minimum.

NOTE: Smaller gauge or longer extension cords may reduce sprayer performance.

Pails

For disinfectants with alcohol active ingredients: Follow local code. Use only conductive metal pails. Ground the metal pail by either placing it on a grounded surface, or by attaching a ground wire.

Grounded surface method: Place pail on a grounded surface such as concrete. Do not place pail on a non-conductive surface such as paper or cardboard which interrupts grounding continuity.



Ground wire method: Connect a ground wire to the pail. Clamp one end to the pail and the other end to a true earth ground such as a water pipe.

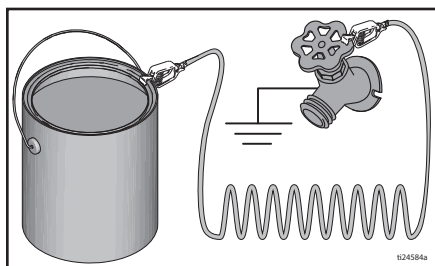

To maintain ground continuity when sprayer is flushed or pressure is relieved: Hold metal part of Spray Gun firmly to the side of a grounded metal pail then trigger the Spray Gun.

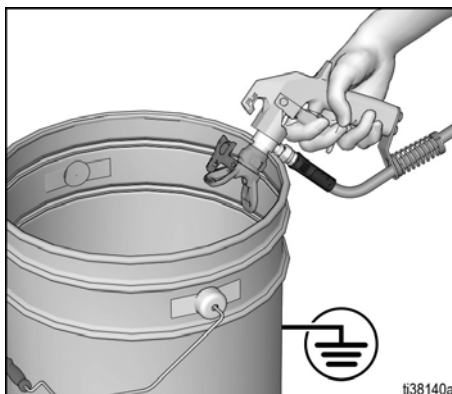

Setup

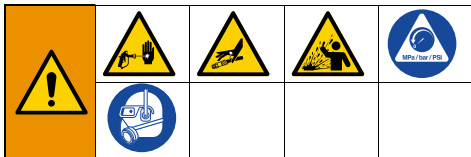

When unpacking sprayer for the first time or after long term storage, perform Setup procedure.

1. Connect 1/4" Graco Airless Hose to Fluid Outlet Fitting (remove red storage plug from fitting if present). Use wrenches to tighten securely.

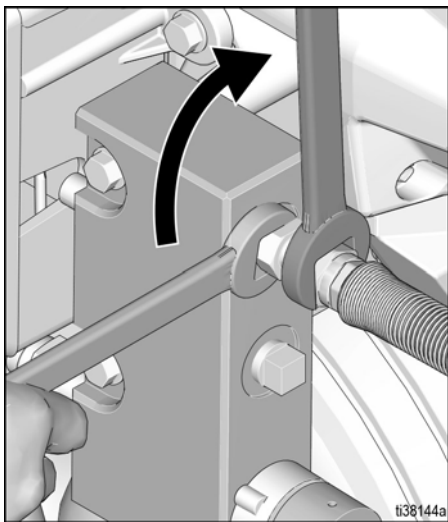

2. Assemble optional 1/8" Airless Whip Hose to end of 1/4" Airless Hose. Use wrenches to tighten securely.

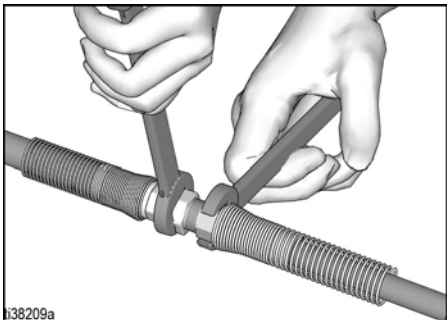

3. Insert other end of Airless Whip Hose through Hose Guard at base of Spray Gun. Connect to Spray Gun. Use wrenches to tighten securely.

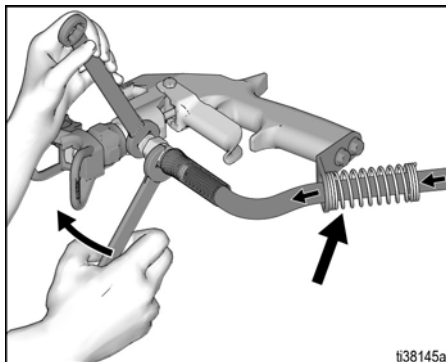

4. Remove Spray Tip Guard assembly from Spray Gun.

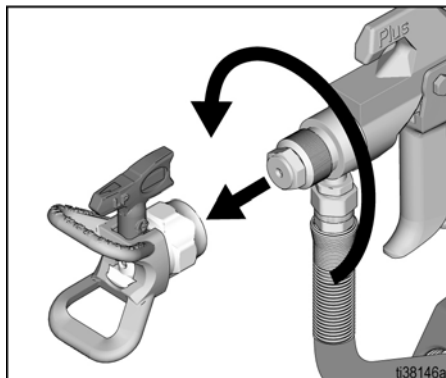

NOTE: This sprayer can be configured to spray with two guns. To setup:

- a. Replace plug in manifold with provided fitting.
- b. Follow **Setup** instructions 1-4 for assembly of second Airless Hose and Spray Gun.

The provided fitting may also be used to connect two 50 foot hoses to provide 100 feet of hose to one Spray Gun.

Start Up

Start Up

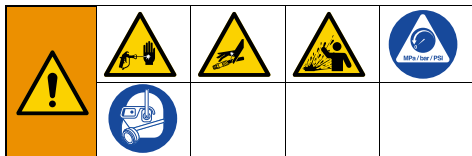

Pressure Relief Procedure



Follow the Pressure Relief Procedure whenever you see this symbol.

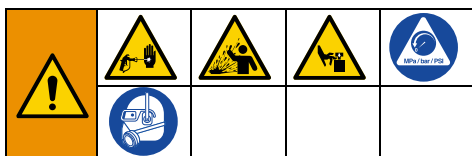

This equipment stays pressurized until pressure is manually relieved. To help prevent serious injury from pressurized fluid, such as skin injection, splashing fluid and moving parts, follow the **Pressure Relief Procedure** whenever sprayer is stopped and before sprayer is cleaned or checked, and before equipment is serviced.

1. Turn ON/OFF Switch to the **OFF** position.



2. Engage the Trigger Lock. Always engage the Trigger Lock when sprayer is stopped to prevent the Spray Gun from being triggered accidentally.

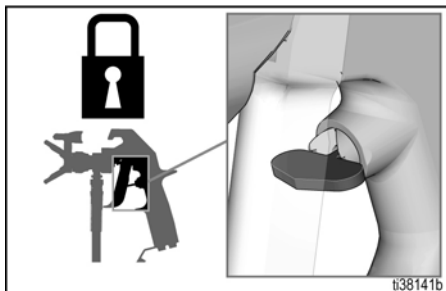

3. Turn Pressure Control Knob to the lowest setting.

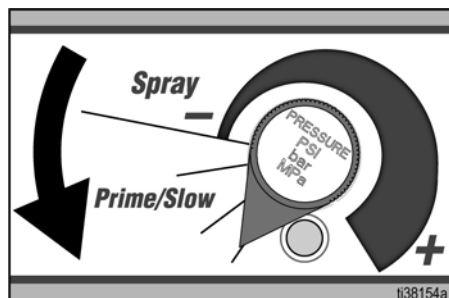

4. Put Drain Tube in a pail and turn Prime/Spray Valve down to PRIME position to relieve pressure.

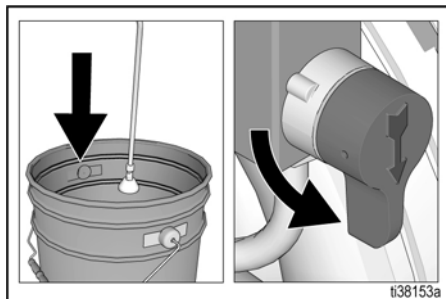

5. Hold a metal part of the Spray Gun firmly to a grounded metal pail. Point Spray Gun into pail. Disengage the Trigger Lock and trigger the Spray Gun to relieve pressure.

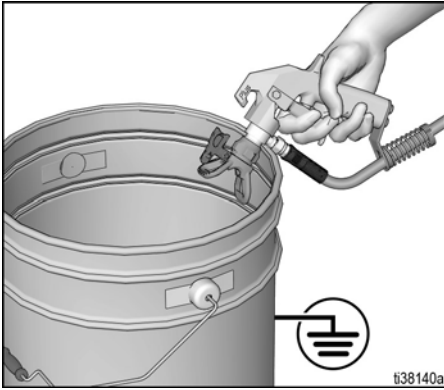

6. Engage the Trigger Lock.

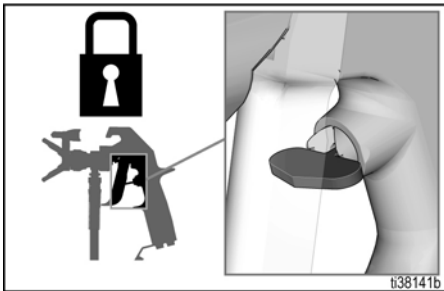

7. If you suspect the Spray Tip or Airless Hose is clogged or that pressure has not been fully relieved:
 - a. **VERY SLOWLY** loosen the Spray Tip Guard retaining nut or the Airless Hose end coupling to relieve pressure gradually.
 - b. Loosen the nut or coupling completely.
 - c. Clear hose or tip obstruction.

Trigger Lock

Always engage the Trigger Lock when sprayer is stopped to prevent the Spray Gun from being triggered accidentally by hand or if dropped or bumped.

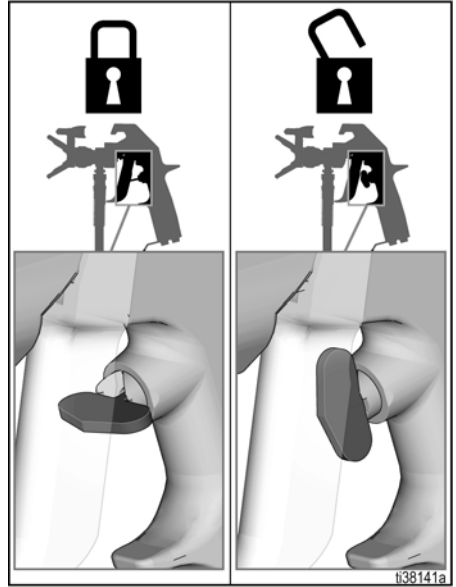

Start Up

Flushing a New Sprayer

This sprayer arrives from the factory with a small amount of test fluid in the system. **It is important that you flush this fluid from the sprayer before using it for the first time.**

1. Perform **Pressure Relief Procedure**, page 12.
2. Make certain ON/OFF Switch is **OFF**.



3. Place Suction Tube with Drain Tube in grounded metal pail partially filled with warm water. See **Grounding**, page 10.

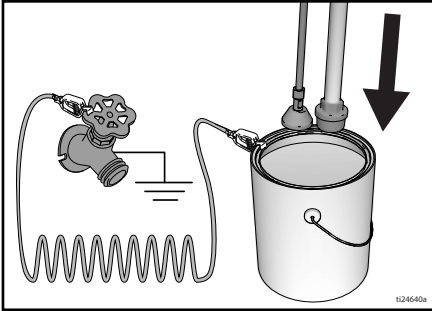

4. Turn Prime/Spray Valve down to PRIME position.

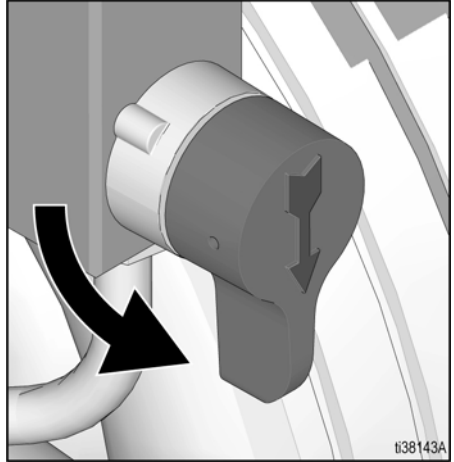

5. Plug power supply cord into a properly grounded electrical outlet.

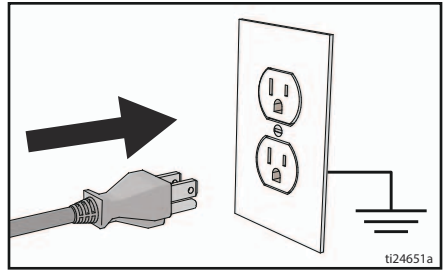

- Turn ON/OFF Switch to **ON** position.

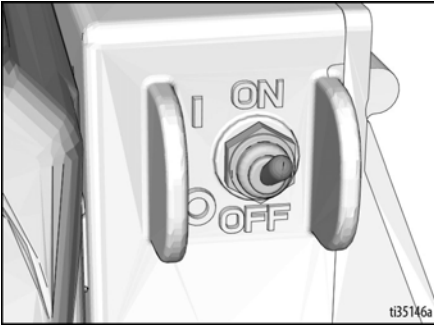

- Turn Pressure Control Knob to Prime/Slow to start motor.

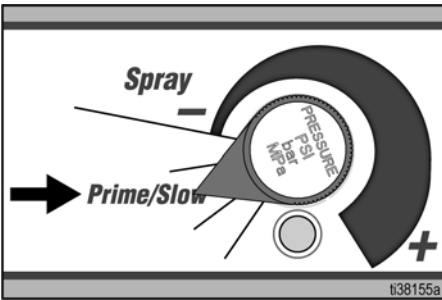

- When sprayer starts pumping, water and air bubbles will be purged from the system. Allow fluid to flow out of drain tube for 1 to 3 minutes.
- Turn ON/OFF Switch to **OFF** position.

Fill Pump

Refer to disinfectant label for manufacturer's directions on proper use. If dilution is required, properly dilute disinfectant prior to use.

- Turn Pressure Control Knob to lowest setting.

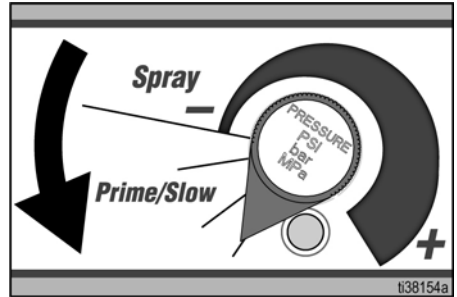

- Turn ON/OFF Switch to **ON** position.

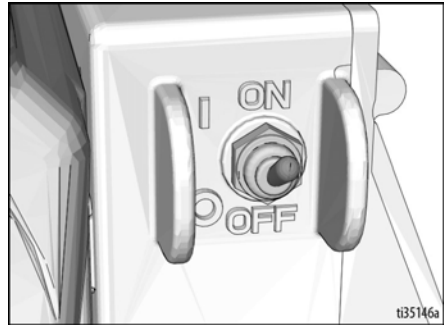

- Place Suction Tube in pail of properly prepared disinfectant. Place Drain Tube in waste bucket.

Start Up

4. Turn Pressure Control Knob to Prime/Slow to start motor. Wait until disinfectant flows from the Drain Tube.

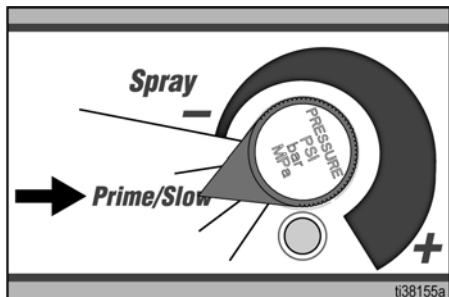

5. Turn ON/OFF Switch to **OFF** position.

Fill Spray Gun and Airless Hose

1. Hold Spray Gun against grounded metal waste bucket. Point Spray Gun into waste bucket.
 - a. Disengage Trigger Lock.
 - b. Pull and hold Spray Gun trigger.
 - c. Turn Prime/Spray Valve horizontal to SPRAY position.
 - d. Turn ON/OFF Switch to **ON** position.

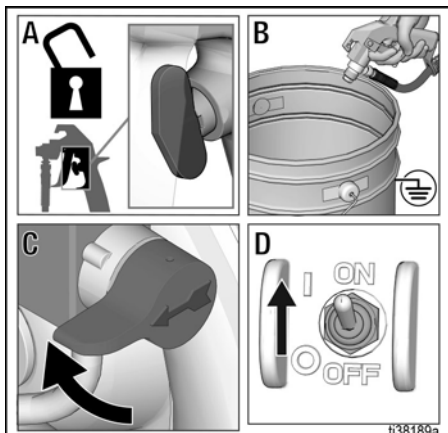

2. Trigger Spray Gun into waste bucket until only disinfectant comes out.
3. Release trigger. Engage Trigger Lock.



High-pressure spray is able to inject toxins into the body and cause serious bodily injury. Do not stop leaks with hand or rag.

4. Inspect Airless Hose connections for leaks. If leaks occur, perform **Pressure Relief Procedure**, page 12, then tighten all fittings and repeat **Start Up**. If there are no leaks, continue with the next step.
5. Clip Drain Tube to Suction Tube.

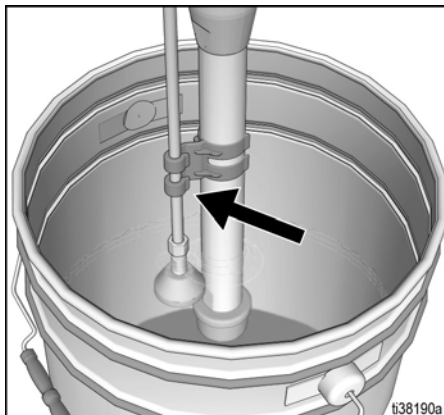

NOTE: When motor stops, sprayer is pressurized. If motor continues to run, sprayer is not properly primed, repeat **Fill Pump** and **Fill Spray Gun and Airless Hose**, pages 15 and 16.

How to Spray

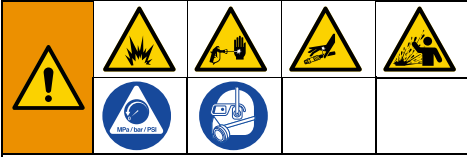

Use only disinfectants approved for spray application.

Fumes from disinfectants with alcohol active ingredients, or from other flammable disinfectants, can explode or ignite. Pump motor generates sparks. To help prevent fumes from exploding or igniting:

- Keep pump at least 20 ft from spray area.
- Do not spray pump.
- Keep spray area well-ventilated.
- Keep a good supply of fresh air moving through the area.

Choose Your Spray Tip



To avoid serious injury from skin injection, do not put your hand in front of the Spray Tip when installing or removing the Spray Tip and Spray Tip Guard.

Your sprayer comes with 3 Spray Tip sizes:

Fine	FFLP310
Medium	LP515
Coarse	LP619

Select the appropriate Spray Tip size to provide the acceptable spray of disinfectant. Refer to the disinfectant label for manufacturer's recommendations.

To prevent Spray Tip leaks, make certain Spray Tip and Spray Tip Guard are installed properly.

1. Perform **Pressure Relief Procedure**, page 12.

2. Use Spray Tip (A) to align TipSeal™ (B) (gasket and seal) into the Spray Tip Guard (C).

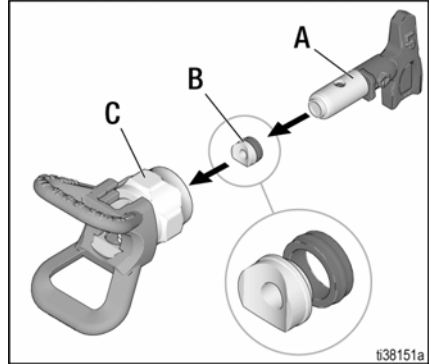

3. Insert Spray Tip into Spray Tip Guard. Verify Spray Tip is forward in the SPRAY position.

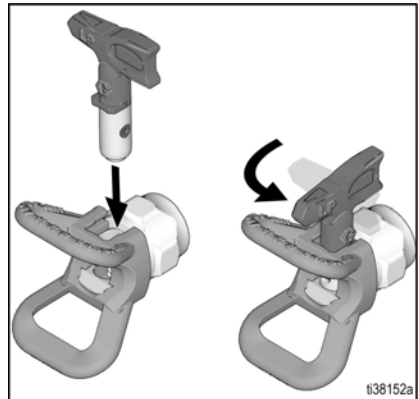

4. Screw Spray Tip Guard assembly onto Spray Gun and tighten.

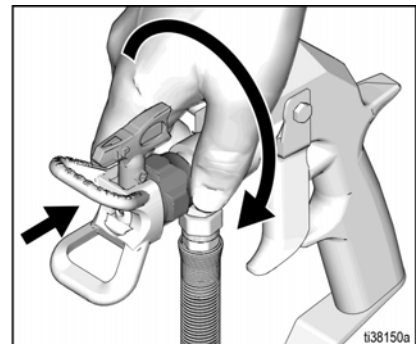

NOTE: Spray Tip will wear with use and need periodic replacement.

How to Spray

Spray Tip Orientation



To avoid serious injury from skin injection, do not put your hand in front of the Spray Tip Guard when rotating it.

Adjust the Spray Tip Guard for desired vertical or horizontal spraying direction.

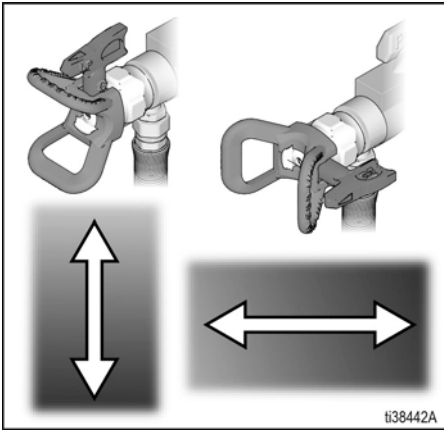

Starting Your Spray and Adjusting Pressure

Always refer to the disinfectant manufacturer's recommendations for an acceptable spray of disinfectant.

1. Point Spray Gun towards the surface to be sprayed.
2. Confirm the Pressure Control Knob is at the lowest setting.
3. Disengage Trigger Lock.
4. Pull and hold Spray Gun trigger.
5. Slowly increase pressure using the Pressure Control Knob. Set to the minimum setting necessary to produce an acceptable spray of disinfect. This will help reduce overspray.



6. Adjust the Spray Gun's distance from the surface and your hand speed to achieve the desired surface coverage.

Clear Tip Clog



To avoid injury, never point gun at your hand or into a rag!

In the event debris clogs the Spray Tip, the Spray Gun is designed with a reversible Spray Tip that quickly and easily clears the particles without disassembling the Spray Gun.

1. Release Trigger. Engage Trigger Lock. Rotate Spray Tip to UNCLOG position. Disengage Trigger Lock. Trigger Spray Gun into waste bucket to clear clog.

UNCLOG



2. Engage Trigger Lock. Rotate Spray Tip back to SPRAY position. Disengage Trigger Lock and continue spraying.

SPRAY

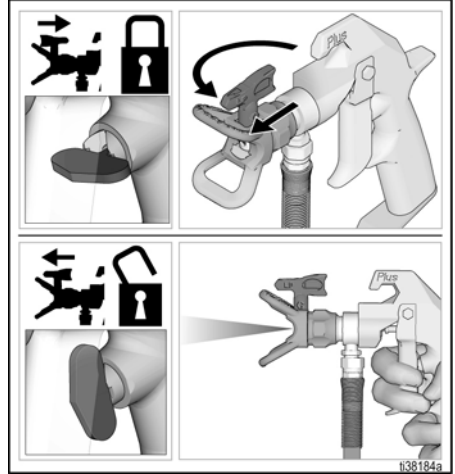

Cleanup

Cleanup

Cleaning the sprayer is required after each use to remove any disinfectants and residues from the sprayer. It will also help ensure a trouble free start up the next time the sprayer is used.



Use only water for cleaning.

Clean in a well-ventilated area. Keep a good supply of fresh air moving through the area.

NOTICE

Disinfectant left in sprayer will damage the sprayer. To avoid damage, always completely flush with warm water after every use. See **Cleanup**, page 20. Do not store sprayer with disinfectant in it.

1. Perform **Pressure Relief Procedure**, page 12.
2. Remove Spray Tip Guard and Spray Tip. For additional information, see **Clean the Gun**, page 23.

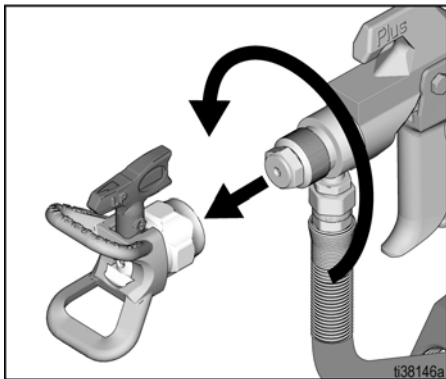

Clean Drain Tube

3. Remove Suction Tube and Drain Tube from pail of disinfectant, wipe excess disinfectant off outside.

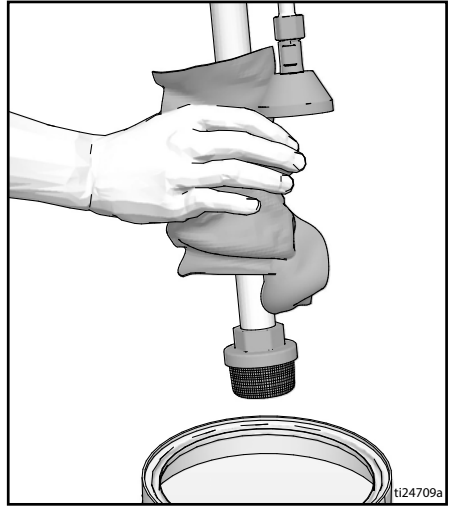

4. Place Suction Tube in bucket of warm water. Place Drain Tube in waste bucket. For disinfectants with alcohol active ingredients, ground the bucket according to **Grounding**, page 10.

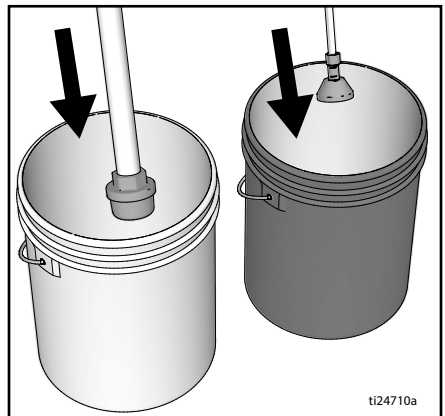

- To flush Drain Tube and Pump, turn Prime/Spray Valve down to PRIME position.

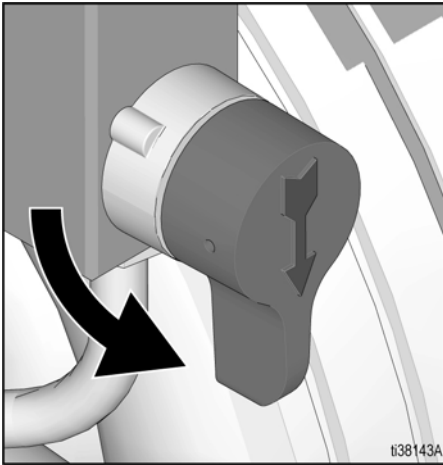

t38143A

- Turn Pressure Control Knob to Prime/Slow and turn ON/OFF Switch to ON position. Allow water to flow out of the Drain Tube into the waste bucket for 1 to 3 minutes.

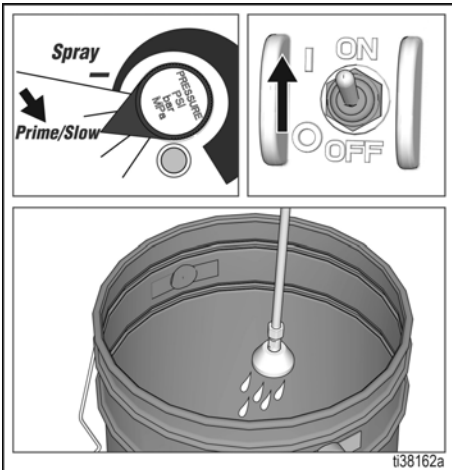

t38162a

- Turn Pressure Control Knob to the lowest setting.

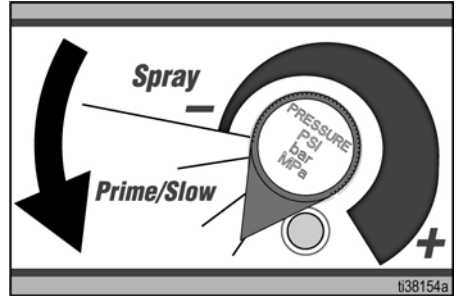

t38154a

Clean Hose and Spray Gun

NOTE: Step 8 is for removing disinfectant from the Airless Hose. One 50 ft Airless Hose holds approximately 1 quart of fluid.

- To remove disinfectant from Airless Hose:
 - Hold Spray Gun against waste bucket.
 - Disengage Trigger Lock.
 - Pull and hold Spray Gun Trigger.
 - Turn Prime/Spray Valve horizontal to SPRAY position.
 - Turn Pressure Control Knob to 12 o'clock position to begin flushing.

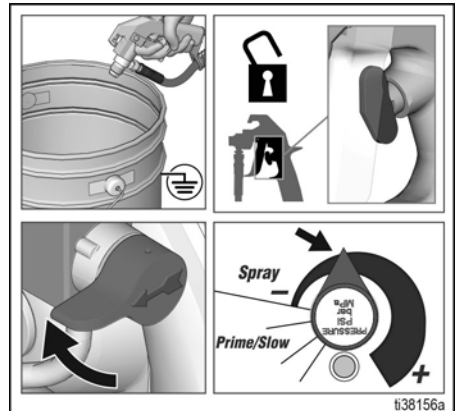

t38156a

Cleanup

- Continue triggering Spray Gun into waste bucket for 1 to 3 minutes.
- Stop triggering Spray Gun. Engage the Trigger Lock.
- Raise Suction Tube above water level.

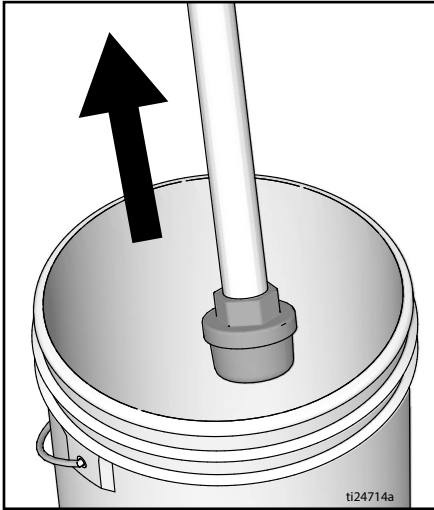

- Disengage the Trigger Lock.
- Trigger Spray Gun into waste bucket until all water is emptied from the Airless Hose. Stop triggering Spray Gun. Engage Trigger Lock.

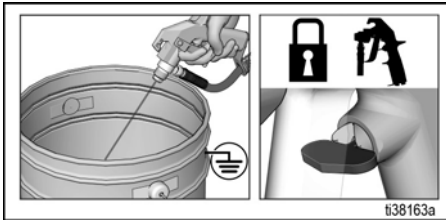

- Turn Prime/Spray Valve down to PRIME position.

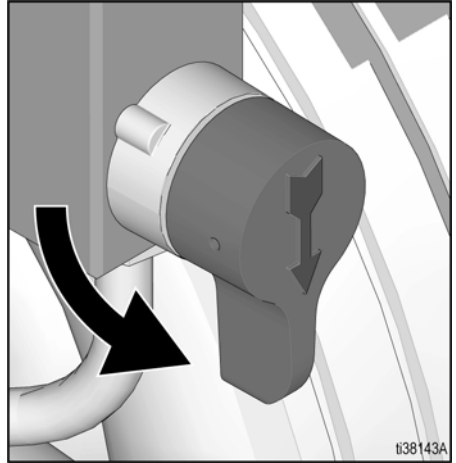

- Turn Pressure Control Knob to lowest setting and turn ON/OFF Switch to OFF position. Disconnect power to sprayer.

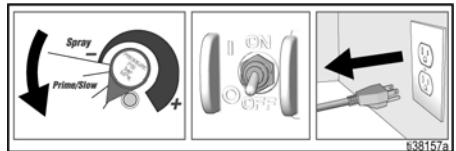

- Wipe sprayer and Airless Hose with soft cloth moistened with water.

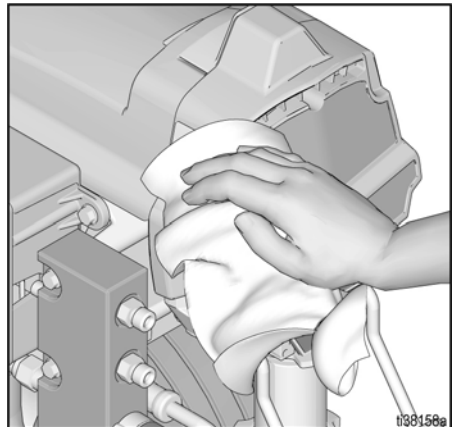

- Dispose of unused disinfectant and fluid in the waste bucket according to the instructions on the disinfectant container label and applicable regulations.

Clean the Gun

- Remove Spray Tip and Spray Tip Guard assembly. Clean with water and a brush.

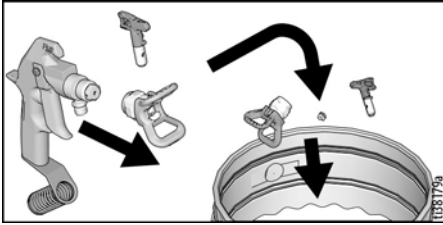

- Wipe Spray Gun with soft cloth moistened with water.

Storage

With proper storage, the sprayer will be ready to use the next time it is needed.

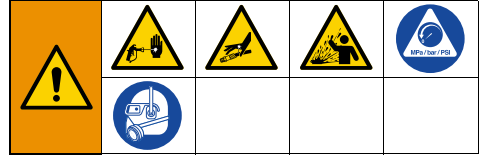

NOTICE

Disinfectant left in sprayer will damage the sprayer. To avoid damage, always completely flush with warm water after every use. See **Cleanup**, page 20. Do not store sprayer with disinfectant in it.

- Before storing sprayer, make sure all water is drained out of sprayer and Airless Hose.
- Do not allow water to freeze in sprayer or Airless Hose.
- Do not store sprayer under pressure.
- Store sprayer indoors.

Maintenance

Maintenance

Routine maintenance is important to ensure proper operation of your sprayer.

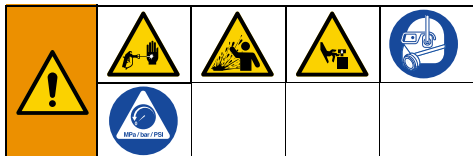

Perform **Pressure Relief Procedure**, page 12, before performing maintenance.

Activity	Interval
Inspect/clean Inlet Strainer.	Daily or each time you spray
Inspect motor shield vents for blockage.	Daily or each time you spray
<p>Check sprayer stall.</p> <p>With Spray Gun NOT triggered, sprayer motor should stall and not restart until Spray Gun is triggered again.</p> <p>If sprayer starts again with Spray Gun NOT triggered, inspect Pump for internal/external leaks and check Prime/Spray Valve for leaks.</p>	Every 1000 gallons (3785 liters)
<p>Throat packing adjustment</p> <p>When Pump packing begins to leak after extended use, tighten packing nut down until leakage stops or lessens. This allows approximately 100 gallons of additional operation before a repacking is required. Packing nut can be tightened without O-ring removal.</p>	As necessary based on usage

Recycling and Disposal

End of Product Life

At the end of the product's useful life, dismantle and recycle it in a responsible manner.

- Perform the **Pressure Relief Procedure**, page 12.
- Drain and dispose of fluids according to applicable regulations. Refer to the material manufacturer's Safety Data Sheet.

- Remove motors, batteries, circuit boards, LCDs (liquid crystal displays), and other electronic components. Recycle according to applicable regulations.
- Do not dispose of electronic components with household or commercial waste.



- Deliver remaining product to a recycling facility.

Troubleshooting

Mechanical/Fluid Flow

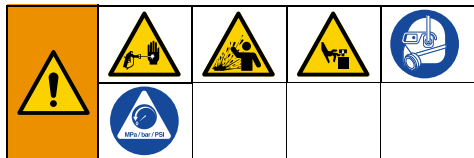

1. Disconnect power cord and follow **Pressure Relief Procedure**, page 12, before checking or repairing.
2. Check all possible problems and causes before disassembling the unit.



Problem	What to Check If check is OK, go to next check	What to Do When check is not OK, refer to this column
Pump output is low	Spray Tip worn.	Follow Pressure Relief Procedure , page 12, then replace Spray Tip.
	Fluid supply.	Refill and reprime Pump.
	Inlet Strainer clogged.	Remove and clean, then reinstall.
	Intake valve ball and piston ball are not seating properly.	Remove intake valve and clean. Check balls and seats for nicks. Replace Pump if necessary. See Parts , pages 34-36.
	Prime/Spray Valve leaking.	Follow Pressure Relief Procedure , page 12, then replace Prime Valve or entire Manifold Assembly. See Parts , pages 34-36.
	Verify Pump does not continue to stroke when Spray Gun trigger is released. (Prime/Spray Valve not leaking.)	Replace Prime Valve and/or Pump if necessary. See Parts , pages 34-36.
	Leaking around throat packing nut which may indicate worn or damaged packings.	Replace Pump if necessary. See Parts , pages 34-36.

Problem	What to Check If check is OK, go to next check	What to Do When check is not OK, refer to this column
Pump output is low	Pump rod damage.	Replace Pump if necessary. See Parts , pages 34-36.
	Low stall pressure.	Turn pressure knob fully clockwise. Make sure Pressure Control Knob is properly installed to allow full clockwise position. If problem persists, replace Transducer or entire Control Assembly. See Parts , pages 34-36.
	Piston packings are worn or damaged.	Replace Pump if necessary. See Parts , pages 34-36.
	O-ring in Pump is worn or damaged.	Replace Pump if necessary. See Parts , pages 34-36.
	Large pressure drop in hose with heavy materials.	Reduce overall length of hose.
	Check extension cord for correct size.	See Extension Cords , page 10.
Motor runs but Pump does not stroke	Connecting rod assembly damaged.	Replace Motor and Drive assembly. See Parts , pages 34-36.
	Gears or drive housing damaged.	Inspect drive housing assembly and gears for damage. Replace Motor and Drive assembly if necessary. See Parts , pages 34-36.
Excessive material leakage into throat packing nut	Throat packing nut is loose.	Remove throat packing nut spacer. Tighten throat packing nut just enough to stop leakage.
	Throat packings are worn or damaged.	Replace Pump assembly. See Parts , pages 34-36.
	Displacement rod is worn or damaged.	Replace Pump assembly. See Parts , pages 34-36.
Fluid is spitting from Spray Gun	Air in Pump or hose.	Check and tighten all fluid connections. Cycle Pump as slowly as possible during priming.
	Fluid supply is low or empty.	Refill fluid supply. Prime Pump. Check fluid supply often to prevent running Pump dry.

Troubleshooting

Problem	What to Check If check is OK, go to next check	What to Do When check is not OK, refer to this column
Pump is difficult to prime	Air in Pump or hose.	Check and tighten all fluid connections. Cycle Pump as slowly as possible during priming.
	Intake valve is leaking.	Clean intake valve. Be sure ball seat is not nicked or worn and that ball seats well. Reassemble valve.
	Pump packings are worn.	Replace Pump assembly. See Parts , pages 34-36.
Sprayer operates for 5 to 10 minutes then stops	Pump packing nut too tight. When Pump packing nut is too tight the packings on the Pump rod restrict Pump action and overloads the motor.	Loosen Pump packing nut. Check for leaks around throat. If necessary, replace Pump assembly. See Parts , pages 34-36.

Electrical

Symptom: Sprayer does not run, stops running, or will not shut off.



1. Perform **Pressure Relief Procedure**, page 12.
2. Plug sprayer into correct voltage, grounded outlet.
3. Turn the ON/OFF Switch **OFF** wait 30 seconds and then turn power back **ON** again (this ensures sprayer is in normal run mode).

4. Turn Pressure Control Knob clockwise 1/2 turn.
5. Turn the ON/OFF Switch **OFF**, remove the control cover then turn power back **ON**. Observe the status light. Blinking LED total count equals the error code (for example: two blinks equals CODE 02).



Keep clear of electrical and moving parts during troubleshooting procedures. To avoid electrical shock hazards when covers are removed for troubleshooting, wait 5 minutes after disconnecting Power Cord for stored electricity to dissipate.

Error Code Messages



CODE	MESSAGE	ACTION
02	HIGH PRESSURE DETECTED - RELIEVE PRESSURE	Check for clogs. Use only Graco Airless Hoses, use a minimum of 50 ft.
03	PRESSURE TRANSDUCER NOT DETECTED	Check transducer connection.
05	MOTOR NOT SPINNING	Check for mechanical failure and check motor connections.
06	MOTOR OVERHEATED	Turn sprayer OFF. Check motor connections. Check shroud vents for blockage. Sprayer may take up to an hour to cool.

Troubleshooting

Problem	What to Check	How to check
Sprayer does not shut off AND Control board status light blinks 2 times repeatedly	Control board.	Replace control box or control assembly. See Parts , pages 34-36.
Sprayer does not run at all AND Control board status light blinks 2 times repeatedly	Check transducer or transducer connections	<p>Make sure there is no pressure in the system (see Pressure Relief Procedure, page 12). Check fluid path for clogs, such as clogged Inlet Strainer.</p> <p>Use airless spray hose with no metal braid. A small hose or metal braid hose may result in high-pressure spikes.</p> <p>Turn ON/OFF Switch OFF and disconnect power to sprayer. Check transducer and connections to control board.</p> <p>Disconnect transducer from control board socket. Check that transducer and control board contacts are clean and secure.</p> <p>Reconnect transducer to control board socket. Connect power, turn ON/OFF Switch ON and control knob 1/2 turn clockwise. If sprayer does not run properly, turn ON/OFF Switch OFF and go to next step.</p> <p>Install new transducer. Connect power, turn ON/OFF Switch ON and turn control knob half turn clockwise. Replace Control Box or Control Assembly if sprayer does not run properly. See Parts, pages 34-36.</p>
Sprayer does not run at all AND Control board status light blinks 3 times repeatedly	Check transducer or transducer connections (control board is not detecting a pressure signal).	<p>Turn ON/OFF Switch OFF and disconnect power to sprayer. Check transducer and connections to control board.</p> <p>Disconnect transducer from control board socket. Check to see if transducer and control board contacts are clean and secure.</p> <p>Reconnect transducer to control board socket. Connect power, turn ON/OFF Switch ON and control knob to 1/2 turn clockwise. If sprayer does not run, turn ON/OFF Switch OFF and go to next step.</p> <p>Connect a confirmed working transducer to control board.</p> <p>Turn ON/OFF switch ON and turn control knob half turn clockwise. If sprayer runs, install new transducer. Replace control box or Control Assembly if sprayer does not run.</p> <p>Check transducer resistance with an ohmmeter (less than 9k ohm between red and black wires and 3-6k ohm between green and yellow wires).</p>

Problem	What to Check	How to check
Sprayer does not run at all AND Control board status light blinks 5 times repeatedly	Control is commanding motor to run but motor shaft does not rotate. Possibly locked rotor condition, an open connection exists between motor and control, there is a problem with motor or control board, or motor amp draw is excessive.	<ol style="list-style-type: none">1. Remove Pump and try to run sprayer. If motor runs, check for locked or frozen Pump or drive train. If sprayer does not run, continue to step 2.2. Turn ON/OFF Switch OFF and disconnect power to sprayer.3. Disconnect motor connector(s) from control board socket(s). Check that motor connector and control board contacts are clean and secure. If contacts are clean and secure, continue to step 4.4. Set sprayer to OFF and spin motor fan 1/2 turn. Restart sprayer. If sprayer runs replace control box or control assembly. If sprayer does not run, continue to step 5.

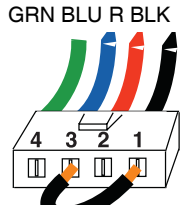
Troubleshooting

Problem	What to Check	How to check
		<p>5. Perform Spin Test: Test at large 4-pin motor field connector. Disconnect fluid Pump from sprayer. Test motor by placing a jumper across pins 1 & 2. Rotate motor fan at about 2 revolutions per second. A cogging resistance to motion should be felt at the fan. The motor should be replaced if no resistance is felt. Repeat for pin combinations 1 & 3 and 2 & 3. Pin 4 (the green wire) is not used in this test. If all spin test is positive, continue to step 6.</p> <p>STEP 1:</p>  <p>STEP 2:</p>  <p>STEP 3:</p> 
		<p>6. Perform Field Short Test: Test at large 4-pin motor field connector. There should not be continuity from pin 4, the ground wire, and any of the remaining 3 pins. If motor field connector tests fail, replace motor.</p> <p>7. Reconnect motor connector(s) to control board socket(s). Connect power, turn ON/OFF Switch ON and control knob to 1/2 turn clockwise. If motor does not run, replace control box or control assembly.</p>

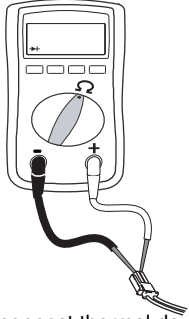
Problem	What to Check	How to check
<p>Sprayer does not run at all AND Control board status light blinks 6 times repeatedly</p>	<p>Motor is hot or there is a fault in the motor thermal device.</p>	<p>Allow sprayer to cool. If sprayer runs when cool, correct cause of overheating. Keep sprayer in cooler location with good ventilation. Make sure motor air intake is not blocked. If sprayer still does not run, replace motor. NOTE: Motor must be cooled down for the test.</p> <ol style="list-style-type: none"> 1. Check thermal device connector (yellow wires) at control board. 2. Disconnect thermal device connector from control board socket. Make sure contacts are clean and secure. Measure resistance of the thermal device. If reading is not correct, replace Motor and Drive Assembly.
		<p>Check Motor Thermal Switch: Unplug thermal wires. Set meter to ohms. Meter should read 100k ohms.</p>  <ol style="list-style-type: none"> 3. Reconnect thermal device connector to control board socket. Connect power, turn sprayer ON and control knob 1/2 turn clockwise. If sprayer does not run, replace control box or control assembly.
<p>Basic electrical problems</p>	<p>Motor leads are securely fastened and properly mated</p> <p>Motor armature commutator for burn spots, gouges or extreme roughness.</p>	<p>Replace loose terminals; crimp to leads. Be sure terminal are firmly connected. Clean circuit board terminals. Securely reconnect leads.</p> <p>Remove motor and have motor shop resurface commutator if possible.</p>

Parts - SaniSpray HP 130 (Quick Repair)

Parts - SaniSpray HP 130 (Quick Repair)

 Torque to 140-160 in-lb (15.8-18.1 N•m)

 Hammer Tight

 Torque to 30-35 in-lb (3.4-4.0 N•m)

 Torque to 25-30 ft-lb (33.9-47.0 N•m)

 Torque to 23-27 in-lb (2.6-3.0 N•m)

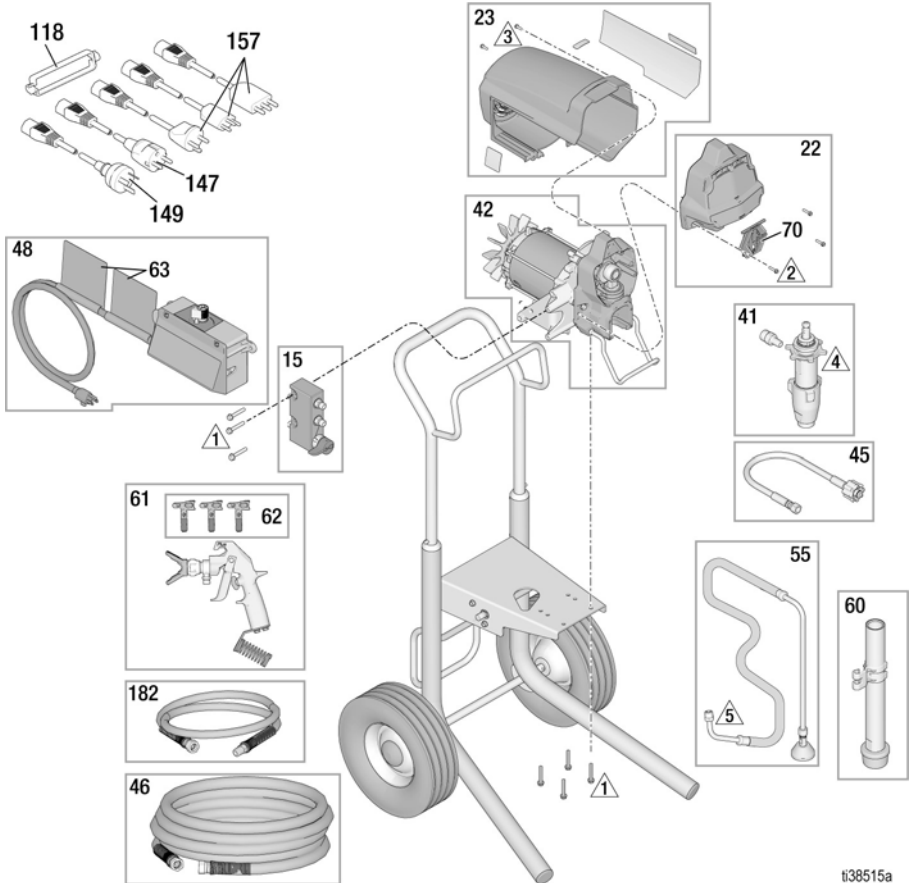

t38515a

Parts - SaniSpray HP 130 (Quick Repair)

Parts List - SaniSpray HP 130 (Quick Repair)

Ref.	Sprayer Model	Part	Description	Qty.
15	All	25T412	KIT, manifold assembly	1
22	All	25T411	KIT, front cover	1
23	All	25T422	KIT, motor enclosure	1
24	All	16A005	FITTING, 1/4 NPSM x 1/4 NPT, SST (not shown)	1
41	All	25R916	KIT, pump	1
42	All	25R917	KIT, motor, drive	1
45	All	24W830	KIT, hose, coupled	1
46	All	240794	HOSE, 1/4 in. x 50 ft.	1
48	25R793, 25T301	25T427❖	KIT, control assembly, 120V, <i>includes 63</i>	1
	25R947, 25R955	25T428❖	KIT, control assembly, 230V, Multi, <i>includes 63</i>	
	25R951	25T429	KIT, control assembly, 110V, UK, <i>includes 63</i>	
55	All	25T413	KIT, drain line	1
60	All	25T423	KIT suction tube	1
61†	25R793	25R874	GUN, SaniSpray HP, NA	1
	25R947, 25R951	25T289	GUN, SaniSpray HP, EU	
	25R955, 25T301	25T290	GUN, SaniSpray HP, AP	
62	All	FFLP310	TIP, FFLP310	1
		LP515 †	TIP, LP515	
		LP619	TIP, LP619	
63▲	All	25T410	KIT, warning labels, cord	1
70	All	17C483	COVER, pump	1
118	25R947, 25R955	195551	PLUG, retainer	1
144	25T301	244285	CORDSET, Japan (not shown)	1
146	25R955	17N232	CORDSET, India (not shown)	1
147	25R947, 25R955	242001	CORDSET, EU Schuko	1
149	25R955	242005	CORDSET, ANZ	1
157	25R947	287121	CORDSET, Italy, Denmark, Switzerland	1
165▲	All		CARD, medical alert (not shown)	1
		222385	English, Spanish, French	
		17F690	Dutch, German, Italian	
		17A134	English, Chinese, Korean	
		17R476	English, Spanish, Portuguese (Brazil)	
		26A997	English, Indonesian, Hindi	
		26A998	English, Chinese, Japanese	
179	All	25T282	EXTENSION, 15 in. (not shown)	1
181*	All	25R872	TIPSEAL, 5-pack (not shown)	1
182	All	25C828	HOSE, 1/8 in. x 4-1/2 ft.	1
❖ Control Kit 25T427 does not include cordset adapter for Japan. Cordset adapter must be ordered separate (see Ref. 144). Control Kit 25T428 does not include cordset adapter. Cordset adapter must be ordered separate (see Ref. 146-157).				
* Two extra TipSeals (polymer spray tip seals) are included with the sprayer. For disinfectant applications, use TipSeal (polymer spray tip seal) instead of the OneSeal (metal seal) that is included with the replacement spray tips.				
† SaniSpray HP Gun includes LP515 Spray Tip.				
▲Replacement safety labels, tags, and cards are available at no cost.				

Parts - SaniSpray HP 130 (Extended Repair)

Parts - SaniSpray HP 130 (Extended Repair)

 Torque to 140-160 in-lb (15.8-18.1 N•m)

 Torque to 20-25 in-lb (2.3-2.8 N•m)

 Torque to 37-43 in-lb (50.2-58.3 N•m)

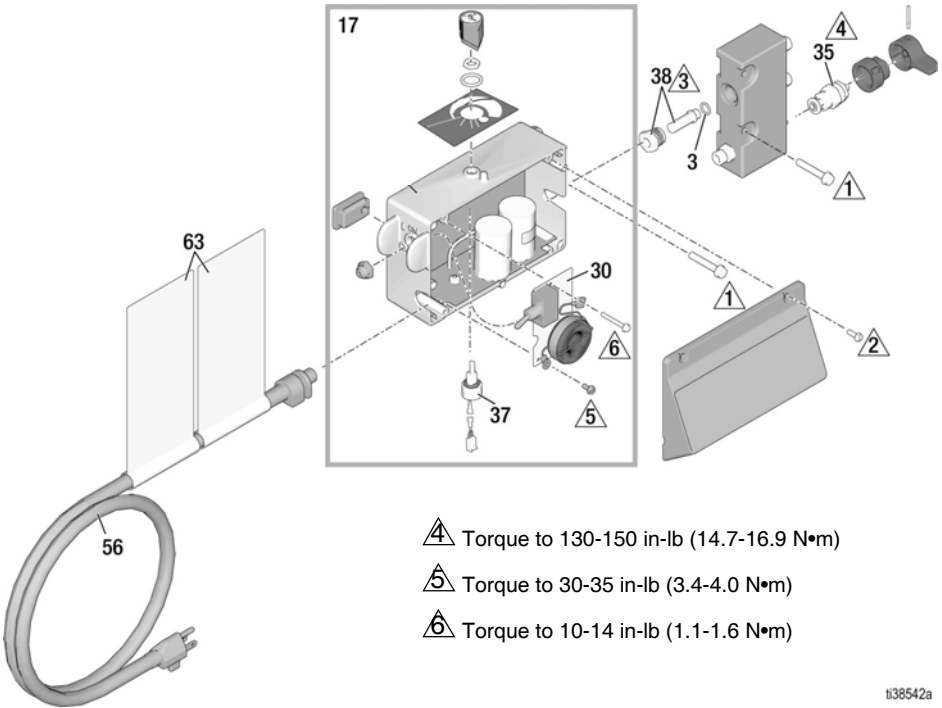

 Torque to 130-150 in-lb (14.7-16.9 N•m)

 Torque to 30-35 in-lb (3.4-4.0 N•m)

 Torque to 10-14 in-lb (1.1-1.6 N•m)

i38542a

Ref.	Sprayer Model	Part	Description	Qty.
17	25R793, 25T301	25T404	KIT, control box, 100-120V	1
	25R947, 25R955	25T406	KIT, control box, 220-240V	
	25R951	25T405	KIT, control box, 110V UK	
30	25R793, 25T301	25T407	KIT, filter board, 100-120V	1
	25R947, 25R955	25T408	KIT, filter board, 220-240V	
	25R951	25T409	KIT, filter board, 100V UK	
35	All	239914	KIT, prime valve	1
37	All	256219	POTENTIOMETER	1
38	All	243222	KIT, transducer	1
56	25R793, 25T301	25T293	CORD, power, USA	1
	25R947, 25R955	15B471	CORD, power, multicord	
	25R951	15B469	CORD, power, UK	
63▲	All	25T410	KIT, warning labels, cord	1

▲Replacement safety labels, tags, and cards are available at no cost.

Wiring Diagrams

Wiring Diagrams

120V

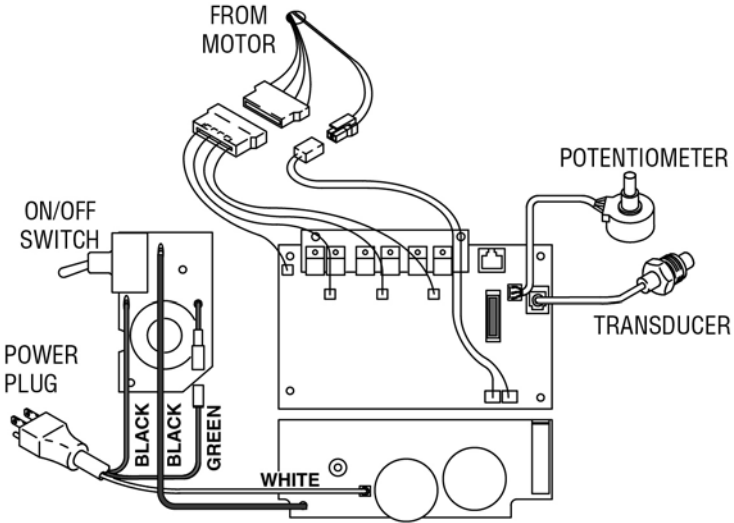

t37024a

110V UK & 220-240V

NOTICE

Heat from inductor coil of filter board may destroy wire insulation that comes in contact with it. Exposed wires could cause shorts and component damage. Bundle and tie loose wires so none lay in contact with inductor coil on the filter board.

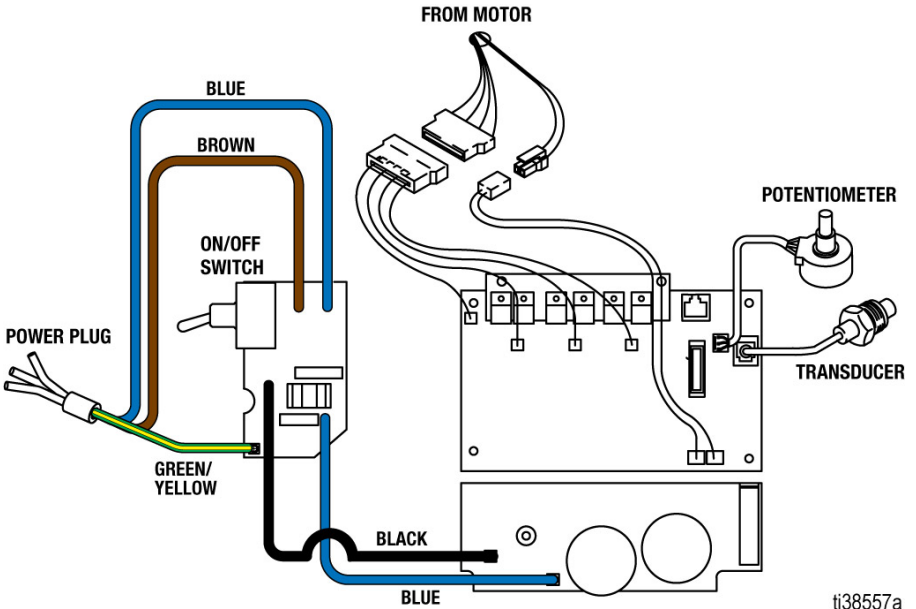

ti38557a

Technical Specifications

Technical Specifications

SaniSpray HP 130 Cart Airless Sprayer		
	US	Metric
Sprayer		
Maximum fluid working pressure	1000 psi	69 bar, 6.9 MPa
Maximum Delivery	1.0 gpm	3.8 lpm
Maximum Tip Size		
Single Gun	0.031 in	0.79 mm
Two Guns	0.023 in	0.58 mm
Fluid Outlet npsm	1/4 in.	
Generator Minimum	4000 W	
Power Requirements	100-120V, 15A, 1Ø or 220-240V, 9A, 1Ø	
Dimensions		
Height	28.25 in. (Handle down) 38.25 in. (Handle up)	71.8 cm (Handle down) 97.2 cm (Handle up)
Length	23.25 in.	59.1 cm
Width	20.5 in.	52.1 cm
Weight	75 lb.	34 kg
Noise** (dBa) @ 70 psi (0.48 MPa, 4.8 bar)		
Sound pressure	90 dBa	
Sound power	100 dBa	
Materials of Construction		
Wetted materials on all models	stainless steel, PTFE, acetal, leather, UHMWPE, anodized aluminum, tungsten carbide, polyethylene, fluoroelastomer, urethane, nylon, PE-RT	
Notes		
* <i>Startup pressures and displacement per cycle may vary based on suction condition, discharge head, air pressure, and fluid type.</i>		
** <i>Sound pressure measured 3 feet (1 meter) from equipment.</i>		
Sound power measured per ISO-3744.		
◆ Never store with disinfectant or water in sprayer.		
All trademarks or registered trademarks are the property of their respective owners.		

California Proposition 65

CALIFORNIA RESIDENTS

 **WARNING:** Cancer and reproductive harm –
www.P65warnings.ca.gov.

Graco Warranty

Graco warrants all equipment referenced in this document which is manufactured by Graco and bearing its name to be free of defects in material and workmanship on the date of sale by an authorized Graco distributor to the original purchaser for use. Graco will, for a period of ninety (90) days from the date of sale, provide repair parts for equipment determined by Graco to be defective. This warranty applies only when the equipment is installed, operated and maintained in accordance with Graco's written recommendations.

This warranty does not cover, and Graco shall not be liable for general wear and tear, or any malfunction, damage or wear caused by faulty installation, misapplication, abrasion, corrosion, inadequate or improper maintenance, negligence, accident, tampering, or substitution of non-Graco component parts. Nor shall Graco be liable for malfunction, damage or wear caused by the incompatibility of Graco equipment with structures, accessories, equipment or materials not supplied by Graco, or the improper design, manufacture, installation, operation or maintenance of structures, accessories, equipment or materials not supplied by Graco.

THIS WARRANTY IS EXCLUSIVE, AND IS IN LIEU OF ANY OTHER WARRANTIES, EXPRESS OR IMPLIED, INCLUDING BUT NOT LIMITED TO WARRANTY OF MERCHANTABILITY OR WARRANTY OF FITNESS FOR A PARTICULAR PURPOSE.

Graco's sole obligation and buyer's sole remedy for any breach of warranty shall be as set forth herein. The buyer agrees that no other remedy (including, but not limited to, incidental or consequential damages for lost profits, lost sales, injury to person or property, or any other incidental or consequential loss) shall be available. Any action for breach of warranty must be brought within two (2) years of the date of sale.

GRACO MAKES NO WARRANTY, AND DISCLAIMS ALL IMPLIED WARRANTIES OF MERCHANTABILITY AND FITNESS FOR A PARTICULAR PURPOSE, IN CONNECTION WITH ACCESSORIES, EQUIPMENT, MATERIALS OR COMPONENTS SOLD BUT NOT MANUFACTURED BY GRACO.

These items sold, but not manufactured by Graco (such as electric motors, switches, hose, etc.), are subject to the warranty, if any, of their manufacturer. Graco will provide purchaser with reasonable assistance in making any claim for breach of these warranties.

IN NO EVENT WILL GRACO BE LIABLE FOR INDIRECT, INCIDENTAL, SPECIAL OR CONSEQUENTIAL DAMAGES RESULTING FROM GRACO SUPPLYING EQUIPMENT HEREUNDER, OR THE FURNISHING, PERFORMANCE, OR USE OF ANY PRODUCTS OR OTHER GOODS SOLD HERETO, WHETHER DUE TO A BREACH OF CONTRACT, BREACH OF WARRANTY, THE NEGLIGENCE OF GRACO, OR OTHERWISE.

FOR GRACO NORTH AMERICA CUSTOMERS

Please call 1-844-241-9499 or visit www.graco.com/techsupport regarding any potential defect in equipment under warranty. If the claimed defect is verified, Graco will either, at its discretion, send repair parts for owner installation or replace the product, free of charge. Warranty claims and/or service for this product are not administrated by Graco's distributors or service centers for Graco paint equipment.

FOR GRACO EUROPE, MIDDLE EAST, AFRICA AND ASIA PACIFIC CUSTOMERS

Please contact your regional service center or authorized distributor to administer a warranty claim.

FOR GRACO CANADA CUSTOMERS

The Parties acknowledge that they have required that the present document, as well as all documents, notices and legal proceedings entered into, given or instituted pursuant hereto or relating directly or indirectly hereto, be drawn up in English. Les parties reconnaissent avoir convenu que la rédaction du présente document sera en Anglais, ainsi que tous documents, avis et procédures judiciaires exécutés, donnés ou intentés, à la suite de ou en rapport, directement ou indirectement, avec les procédures concernées.

Graco Information

For the latest information about Graco products, visit www.graco.com.

For patent information, see www.graco.com/patents.

TO PLACE AN ORDER, contact your Graco distributor or call 1-800-690-2894 to identify the nearest distributor.

All written and visual data contained in this document reflects the latest product information available at the time of publication. Graco reserves the right to make changes at any time without notice.

Original instructions. This manual contains English. MM 3A7656

Graco Headquarters: Minneapolis

International Offices: Belgium, China, Japan, Korea

GRACO INC. AND SUBSIDIARIES • P.O. BOX 1441 • MINNEAPOLIS MN 55440-1441 • USA

Copyright 2020, Graco Inc. All Graco manufacturing locations are registered to ISO 9001.

www.graco.com

Revision E, February 2021