

# PR70™ and PR70v™

312759ZAC

with Advanced Display Module

EN

***Fixed or variable ratio systems. For accurate metering, mixing, and dispensing of two-component materials. For professional use only.***

***Not approved for use in European explosive atmosphere locations.***

3000 psi (21 MPa, 207 bar) Maximum Working Pressure

100 psi (0.7 MPa, 7 bar) Maximum Air Inlet Pressure



**Important Safety Instructions**

Read all warnings and instructions in all supplied manuals. Save these instructions.



ti12385b

PR70v Shown with Advanced Display Module



# Contents

<b>Related Manuals</b> .....	<b>3</b>	<b>Troubleshooting</b> .....	<b>70</b>
<b>Product Configurator</b> .....	<b>4</b>	Error Codes .....	72
<b>Warnings</b> .....	<b>11</b>	<b>Kits</b> .....	<b>77</b>
Moisture Sensitivity of Isocyanates .....	13	<b>Dimensions</b> .....	<b>78</b>
<b>Component Identification</b> .....	<b>14</b>	Machine with On-Board Tanks .....	78
Advanced Display Module (ADM) .....	16	Machine with Off-Board Tanks .....	79
<b>Screen Navigation Diagram</b> .....	<b>17</b>	<b>Technical Data</b> .....	<b>80</b>
<b>Grounding</b> .....	<b>18</b>	<b>California Proposition 65</b> .....	<b>81</b>
<b>Installation</b> .....	<b>18</b>	<b>Graco Standard Warranty</b> .....	<b>82</b>
Machine Installation .....	18		
Tank Refill Kit 256577 Installation .....	20		
<b>Startup</b> .....	<b>22</b>		
<b>Setup</b> .....	<b>23</b>		
Setup Screens .....	23		
Edit Settings .....	37		
Piston Position Calibration .....	37		
Prime the Dispense Head .....	39		
Phasing Adjustment .....	40		
Adjust Dispense Valve Snuff Back .....	42		
Adjust Open Dispense Valve (ODV) Timing ...	43		
Calibrate Dispense Weight Ratio (PR70v only) .	44		
Shot Calibration .....	47		
Flow Meter/Ratio Monitoring Calibration .....	48		
Dispense Verification .....	49		
External Control Interface Setup .....	50		
<b>Operation</b> .....	<b>54</b>		
Operation Screens .....	54		
Auto-Refill .....	63		
Temperature Control .....	64		
Purge Timer .....	64		
<b>USB Data</b> .....	<b>65</b>		
USB Logs .....	65		
Download Procedure .....	65		
<b>Pressure Relief</b>			
<b>Procedure</b> .....	<b>66</b>		
<b>Shutdown</b> .....	<b>66</b>		
<b>Maintenance</b> .....	<b>67</b>		
Schedule .....	67		
Clean the Pump Shafts .....	67		
Disassemble and Clean the Dispense Head ...	67		
Flush Pneumatic Air Motor 82/0216/11 .....	68		
Lubricate Pneumatic Air Motor .....	68		
Lubricate Gear Box of Pneumatic Air Motor			
01/0368-1/11 .....	68		
Install Upgrade Token .....	69		
Light Tower (Optional) .....	69		

## Related Manuals

<b>PR70 and PR70v Operation and Parts Manuals</b>	
<b>Part</b>	<b>Description</b>
3A0429	PR70™ with Standard Display Module Operation-Maintenance Manual
312760	PR70™ and PR70v™ Repair-Parts Manual
312394	PR70™ and PR70v™ Feed Systems Instructions-Parts Manual
312761	PR70™ and PR70v™ Integrated Heat Instructions - Parts Manual
334984	PR70f™ with Flow Control Operation-Maintenance Manual
3A6225	PR70™ and PR70f™ Conversion Kit Instructions - Parts Manual
3A8824	PR70™ and PR70v™ ISO Lube Recirculation Kit Instructions-Parts Manual
<b>MD2 Dispense Valve Manual</b>	
<b>Part</b>	<b>Description</b>
312185	MD2 Dispense Valve Instructions and Parts Manual

# Product Configurator

**PR7F** - - - - -

Code:	A	B-C	D-E	F	G-H	I-J	K	L	M	N	O	P	Q	R	S	T	U	V
	Air Motor	High Volume Side Piston	Low Volume Side Piston	Controls	High Volume Side Hose	Low Volume Side Hose	Dispense Valve	Mixer	Applicator Mounting	Power Cord	Flow Monitoring	High Volume Side Tank	High Volume Side Tank Cover	Low Volume Side Tank	Low Volume Side Tank Cover	Tank Level Sensors	Heat Zone Controller	Off-Board Tank Stand

An example of the product configurator would be the following configurator code.

**PR7F** - **J** - **A5** - **A5** - **E** - **A6** - **A6** - **3** - **1** - **2** - **A** - **N** - **3** - **N** - **H** - **N** - **6** - **N** - **N**

Code:	A	B-C	D-E	F	G-H	I-J	K	L	M	N	O	P	Q	R	S	T	U	V
	Air Motor	High Volume Side Piston	Low Volume Side Piston	Controls	High Volume Side Hose	Low Volume Side Hose	Dispense Valve	Mixer	Applicator Mounting	Power Cord	Flow Monitoring	High Volume Side Tank	High Volume Side Tank Cover	Low Volume Side Tank	Low Volume Side Tank Cover	Tank Level Sensors	Heat Zone Controller	Off-Board Tank Stand

The following part number fields apply for the PR70 and PR70v part numbering configurator fields. Shaded items listed in the configurator table below are “Super Standard” items that are typically stocked and provide the best delivery dates.

Code A	Part	Air Motor
A	LC0262	PR70 with 3.0 in. (4.56 mm) Air Motor
B	LC0264	PR70 with 4.5 in. (10.26 mm) Air Motor
C	LC0263	PR70 with 3.0 in. (4.56 mm) Air Motor and Hydracheck
D	LC0265	PR70 with 4.5 in. (10.26 mm) Air Motor and Hydracheck
F	LC0242	PR70v with 3.0 in. (4.56 mm) Air Motor
G	LC0244	PR70v with 4.5 in. (10.26 mm) Air Motor
H	LC0243	PR70v with 3.0 in. (4.56 mm) Air Motor and Hydracheck

J	LC0245	PR70v with 4.5 in. (10.26 mm) Air Motor and Hydracheck
L	LC4000	PR70f with 3.0 in. (4.56 mm) Air Motor and Hydracheck
M	LC4001	PR70f with 4.5 in. (10.26 mm) Air Motor and Hydracheck
P	LC4002	PR70f with 3.0 in. (4.56 mm) Air Motor and Hydracheck
R	LC4003	PR70f with 4.5 in. (10.26 mm) Air Motor and Hydracheck

Code B	Part	High Volume Side Piston and Metering Tube Material
A	LC1___	Nylon Piston, Stainless Steel Metering Tube (last three digits of part number is the mm <sup>2</sup> piston size)
B	LC2___	UHMWPE Piston, Stainless Steel Metering Tube (last three digits of part number is the mm <sup>2</sup> piston size)
C	LC3___	UHMWPE Piston, Ceramic Metering Tube (last three digits of part number is the mm <sup>2</sup> piston size)
Code C	Part	High Volume Piston Size (mm <sup>2</sup> )
1		80, Available in Nylon Only
2		100, Available in Nylon Only
3		120, Available in Nylon Only
4		140, Available in Nylon Only
5		160
6		180
7		200
8		220
9		240
A		260
B		280
C		300
F		320
G		360
H		400
J		440
L		480
M		520
R		560
S		600
T		640
U		720
W		800
X		880
Y		960
Z		Custom High Volume side, consult factory (stainless steel only)
Code D	Part	Low Volume Side Piston and Metering Tube Material
A	LC1___	Nylon Piston, Stainless Steel Metering Tube (last three digits of part number is the mm <sup>2</sup> piston size)
B	LC2___	UHMWPE Piston, Stainless Steel Metering Tube (last three digits of part number is the mm <sup>2</sup> piston size)
C	LC3___	UHMWPE Piston, Ceramic Metering Tube (last three digits of part number is the mm <sup>2</sup> piston size)

Code E	Part	Low Volume Side Piston Size (mm <sup>2</sup> )
1		80, Available in Nylon Only
2		100, Available in Nylon Only
3		120, Available in Nylon Only
4		140, Available in Nylon Only
5		160
6		180
7		200
8		220
9		240
A		260
B		280
C		300
F		320
G		360
H		400
J		440
L		480
M		520
R		560
S		600
T		640
U		720
W		800
X		880
Y		960
Z		Custom Low Volume side, consult factory (stainless steel only)
Code F	Part	Controls
B	LC0272	Standard Display Module with 1 Fluid Control Module
D	LC0274	Advanced Display Module with 1 Fluid Control Module
E	LC0275	Advanced Display Module with 2 Fluid Control Modules
Codes G-H, I-J	Part	High Volume Hose / Low Volume Hose
A1	LC0801	3/16 in. (4.8 mm) - 2.5 ft (0.6 m)
A2	LC0802	3/16 in. (4.8 mm) - 10 ft (3.0 m)
A3	LC0803	3/16 in. (4.8 mm) - 15 ft (4.6 m)
A4	LC0804	1/4 in. (6.5 mm) - 2.5 ft (0.6 m)
A5	LC0805	1/4 in. (6.5 mm) - 10 ft (3.0 m)
A6	LC0806	1/4 in. (6.5 mm) - 15 ft (4.6 m)
A7	LC0807	3/8 in. (9.5 mm) - 2.5 ft (0.6 m)
A8	LC0808	3/8 in. (9.5 mm) - 10 ft (3.0 m)
A9	LC0809	3/8 in. (9.5 mm) - 15 ft (4.6 m)
AA	LC0810	1/2 in. (13 mm) - 2.5 ft (0.6 m)
AB	LC0811	1/2 in. (13 mm) - 10 ft (3.0 m)
AC	LC0812	1/2 in. (13 mm) - 15 ft (4.6 m)
AG	LC0813	3/4 in. (19 mm) - 10 ft (3.0 m)

AH	LC0814	3/4 in. (19 mm) - 15 ft (4.6 m)
B4	LC0881	Heated, 1/4 in. (6.5 mm) - 2.5 ft (0.6 m)
B5	LC0882	Heated, 1/4 in. (6.5 mm) - 10 ft (3.0 m)
B6	LC0883	Heated, 1/4 in. (6.5 mm) - 15 ft (4.6 m)
B7	LC0884	Heated, 3/8 in. (9.5 mm) - 2.5 ft (0.6 m)
B8	LC0885	Heated, 3/8 in. (9.5 mm) - 10 ft (3.0 m)
B9	LC0886	Heated, 3/8 in. (9.5 mm) - 15 ft (4.6 m)
BA	LC0887	Heated, 1/2 in. (13 mm) - 2.5 ft (0.6 m)
BB	LC0888	Heated, 1/2 in. (13 mm) - 10 ft (3.0 m)
BC	LC0889	Heated, 1/2 in. (13 mm) - 15 ft (4.6 m)
BG	LC0890	Heated, 3/4 in. (19 mm) - 10 ft (3.0 m)
BH	LC0891	Heated, 3/4 in. (19 mm) - 15 ft (4.6 m)
C1	LC0161	Recirculating, On-Board Tanks, 3/16 in. (4.8 mm) - 2.5 ft (0.6 m)
C2	LC0162	Recirculating, On-Board Tanks, 3/16 in. (4.8 mm) - 10 ft (3.0 m)
C3	LC0163	Recirculating, On-Board Tanks, 3/16 in. (4.8 mm) - 15 ft (4.6 m)
C4	LC0164	Recirculating, On-Board Tanks, 1/4 in. (6.5 mm) - 2.5 ft (0.6 m)
C5	LC0165	Recirculating, On-Board Tanks, 1/4 in. (6.5 mm) - 10 ft (3.0 m)
C6	LC0166	Recirculating, On-Board Tanks, 1/4 in. (6.5 mm) - 15 ft (4.6 m)
C7	LC0167	Recirculating, On-Board Tanks, 3/8 in. (9.5 mm) - 2.5 ft (0.6 m)
C8	LC0168	Recirculating, On-Board Tanks, 3/8 in. (9.5 mm) - 10 ft (3.0 m)
C9	LC0169	Recirculating, On-Board Tanks, 3/8 in. (9.5 mm) - 15 ft (4.6 m)
CA	LC0170	Recirculating, On-Board Tanks, 1/2 in. (13 mm) - 2.5 ft (0.6 m)
CB	LC0171	Recirculating, On-Board Tanks, 1/2 in. (13 mm) - 10 ft (3.0 m)
CC	LC0172	Recirculating, On-Board Tanks, 1/2 in. (13 mm) - 15 ft (4.6 m)
CD	LC0173	Recirculating, On-Board Tanks, 3/4 in. (19 mm) - 10 ft (3.0 m)
CE	LC0174	Recirculating, On-Board Tanks, 3/4 in. (19 mm) - 15 ft (4.6 m)
D1	LC0175	Recirculating, Off-Board Tanks, 3/16 in. (4.8 mm) - 2.5 ft (0.6 m)
D2	LC0176	Recirculating, Off-Board Tanks, 3/16 in. (4.8 mm) - 10 ft (3.0 m)
D3	LC0177	Recirculating, Off-Board Tanks, 3/16 in. (4.8 mm) - 15 ft (4.6 m)
D4	LC0178	Recirculating, Off-Board Tanks, 1/4 in. (6.5 mm) - 2.5 ft (0.6 m)
D5	LC0179	Recirculating, Off-Board Tanks, 1/4 in. (6.5 mm) - 10 ft (3.0 m)
D6	LC0180	Recirculating, Off-Board Tanks, 1/4 in. (6.5 mm) - 15 ft (4.6 m)
D7	LC0181	Recirculating, Off-Board Tanks, 3/8 in. (9.5 mm) - 2.5 ft (0.6 m)

D8	LC0182	Recirculating, Off-Board Tanks, 3/8 in. (9.5 mm) - 10 ft (3.0 m)
D9	LC0183	Recirculating, Off-Board Tanks, 3/8 in. (9.5 mm) - 15 ft (4.6 m)
DA	LC0184	Recirculating, Off-Board Tanks, 1/2 in. (13 mm) - 2.5 ft (0.6 m)
DB	LC0185	Recirculating, Off-Board Tanks, 1/2 in. (13 mm) - 10 ft (3.0 m)
DC	LC0186	Recirculating, Off-Board Tanks, 1/2 in. (13 mm) - 15 ft (4.6 m)
DD	LC0187	Recirculating, Off-Board Tanks, 3/4 in. (19 mm) - 10 ft (3.0 m)
DE	LC0188	Recirculating, Off-Board Tanks, 3/4 in. (19 mm) - 15 ft (4.6 m)
E1	LC0190	Recirculating, Heated, On-Board Tanks, 1/4 in. (6.5 mm) - 2.5 ft (0.6 m)
E2	LC0191	Recirculating, Heated, On-Board Tanks, 1/4 in. (6.5 mm) - 10 ft (3.0 m)
E3	LC0192	Recirculating, Heated, On-Board Tanks, 1/4 in. (6.5 mm) - 15 ft (4.6 m)
E4	LC0193	Recirculating, Heated, On-Board Tanks, 3/8 in. (9.5 mm) - 2.5 ft (0.6 m)
E5	LC0194	Recirculating, Heated, On-Board Tanks, 3/8 in. (9.5 mm) - 10 ft (3.0 m)
E6	LC0195	Recirculating, Heated, On-Board Tanks, 3/8 in. (9.5 mm) - 15 ft (4.6 m)
E7	LC0196	Recirculating, Heated, On-Board Tanks, 1/2 in. (13 mm) - 2.5 ft (0.6 m)
E8	LC0197	Recirculating, Heated, On-Board Tanks, 1/2 in. (13 mm) - 10 ft (3.0 m)
E9	LC0198	Recirculating, Heated, On-Board Tanks, 1/2 in. (13 mm) - 15 ft (4.6 m)
EA	LC0199	Recirculating, Heated, On-Board Tanks, 3/4 in. (19 mm) - 10 ft (3.0 m)
EB	LC0200	Recirculating, Heated, On-Board Tanks, 3/4 in. (19 mm) - 15 ft (4.6 m)
F1	LC0201	Recirculating, Heated, Off-Board Tanks, 1/4 in. (6.5 mm) - 2.5 ft (0.6 m)
F2	LC0202	Recirculating, Heated, Off-Board Tanks, 1/4 in. (6.5 mm) - 10 ft (3.0 m)
F3	LC0203	Recirculating, Heated, Off-Board Tanks, 1/4 in. (6.5 mm) - 15 ft (4.6 m)
F4	LC0204	Recirculating, Heated, Off-Board Tanks, 3/8 in. (9.5 mm) - 2.5 ft (0.6 m)
F5	LC0205	Recirculating, Heated, Off-Board Tanks, 3/8 in. (9.5 mm) - 10 ft (3.0 m)
F6	LC0206	Recirculating, Heated, Off-Board Tanks, 3/8 in. (9.5 mm) - 15 ft (4.6 m)
F7	LC0207	Recirculating, Heated, Off-Board Tanks, 1/2 in. (13 mm) - 2.5 ft (0.6 m)
F8	LC0208	Recirculating, Heated, Off-Board Tanks, 1/2 in. (13 mm) - 10 ft (3.0 m)
F9	LC0209	Recirculating, Heated, Off-Board Tanks, 1/2 in. (13 mm) - 15 ft (4.6 m)

FA	LC0210	Recirculating, Heated, Off-Board Tanks, 3/4 in. (19 mm) - 10 ft (3.0 m)
FB	LC0211	Recirculating, Heated, Off-Board Tanks, 3/4 in. (19 mm) - 15 ft (4.6 m)
GA	LC0400	High Pressure, 3/8 in. (9.5 mm) - 2.5 ft (0.6 m)
GB	LC0401	High Pressure, 3/8 in. (9.5 mm) - 10 ft (3.0 m)
GC	LC0402	High Pressure, 3/8 in. (9.5 mm) - 15 ft (4.6 m)
GD	LC0403	High Pressure, 1/2 in. (13 mm) - 2.5 ft (0.6 m)
GE	LC0404	High Pressure, 1/2 in. (13 mm) - 10 ft (3.0 m)
GF	LC0405	High Pressure, 1/2 in. (13 mm) - 15 ft (4.6 m)
GH	LC0406	High Pressure, 3/4 in. (19 mm) - 10 ft (3.0 m)
GJ	LC0407	High Pressure, 3/4 in. (19 mm) - 15 ft (4.6 m)
GK	LC0432	High Pressure, Recirculating, On-Board Tanks, 3/8 in. (9.5 mm) - 2.5 ft (0.6 m)
GL	LC0433	High Pressure, Recirculating, On-Board Tanks, 3/8 in. (9.5 mm) - 10 ft (3.0 m)
GM	LC0434	High Pressure, Recirculating, On-Board Tanks, 3/8 in. (9.5 mm) - 15 ft (4.6 m)
GQ	LC0435	High Pressure, Recirculating, On-Board Tanks, 1/2 in. (13 mm) - 2.5 ft (0.6 m)
GR	LC0436	High Pressure, Recirculating, On-Board Tanks, 1/2 in. (13 mm) - 10 ft (3.0 m)
GS	LC0437	High Pressure, Recirculating, On-Board Tanks, 1/2 in. (13 mm) - 15 ft (4.6 m)
GT	LC0438	High Pressure, Recirculating, On-Board Tanks, 3/4 in. (19 mm) - 10 ft (3.0 m)
GU	LC0439	High Pressure, Recirculating, On-Board Tanks, 3/4 in. (19 mm) - 15 ft (4.6 m)
GW	LC0440	High Pressure, Recirculating, On-Board Tanks, 3/8 in. (9.5 mm) - 2.5 ft (0.6 m)
GX	LC0441	High Pressure, Recirculating, On-Board Tanks, 3/8 in. (9.5 mm) - 10 ft (3.0 m)
GY	LC0442	High Pressure, Recirculating, On-Board Tanks, 3/8 in. (9.5 mm) - 15 ft (4.6 m)
G1	LC0443	High Pressure, Recirculating, On-Board Tanks, 1/2 in. (13 mm) - 2.5 ft (0.6 m)

G2	LC0444	High Pressure, Recirculating, On-Board Tanks, 1/2 in. (13 mm) - 10 ft (3.0 m)
G3	LC0445	High Pressure, Recirculating, On-Board Tanks, 1/2 in. (13 mm) - 15 ft (4.6 m)
G4	LC0446	High Pressure, Recirculating, On-Board Tanks, 3/4 in. (19 mm) - 10 ft (3.0 m)
G5	LC0447	High Pressure, Recirculating, On-Board Tanks, 3/4 in. (19 mm) - 15 ft (4.6 m)
HA	LC0472	High Pressure, Heated, 3/8 in. (9.5 mm) - 2.5 ft (0.6 m)
HB	LC0473	High Pressure, Heated, 3/8 in. (9.5 mm) - 10 ft (3.0 m)
HC	LC0474	High Pressure, Heated, 3/8 in. (9.5 mm) - 15 ft (4.6 m)
HF	LC0475	High Pressure, Heated, 1/2 in. (13 mm) - 2.5 ft (0.6 m)
HG	LC0476	High Pressure, Heated, 1/2 in. (13 mm) - 10 ft (3.0 m)
HJ	LC0477	High Pressure, Heated, 1/2 in. (13 mm) - 15 ft (4.6 m)
HL	LC0478	High Pressure, Heated, 3/4 in. (19 mm) - 10 ft (3.0 m)
HM	LC0479	High Pressure, Heated, 3/4 in. (19 mm) - 15 ft (4.6 m)
HQ	LC0480	High Pressure, Heated, 3/8 in. (9.5 mm) - 2.5 ft (0.6 m)
HR	LC0481	High Pressure, Heated, 3/8 in. (9.5 mm) - 10 ft (3.0 m)
HS	LC0482	High Pressure, Heated, 3/8 in. (9.5 mm) - 15 ft (4.6 m)
HT	LC0483	High Pressure, Heated, 1/2 in. (13 mm) - 2.5 ft (0.6 m)
HU	LC0484	High Pressure, Heated, 1/2 in. (13 mm) - 10 ft (3.0 m)
HX	LC0485	High Pressure, Heated, 1/2 in. (13 mm) - 15 ft (4.6 m)
HY	LC0486	High Pressure, Heated, 3/4 in. (19 mm) - 10 ft (3.0 m)
H2	LC0487	High Pressure, Heated, 3/4 in. (19 mm) - 15 ft (4.6 m)
NN	---	Not required
Code K	Part	Dispense Valve
N	N/A	None
2	255179	MD2, Valve Only with 1:1 Nose
3	255181	MD2, Valve Only with 10:1 Nose
4	LC0120	MD2, Handheld with 1:1 Nose
5	LC0122	MD2, Handheld with 10:1 Nose
6	LC0121	MD2, Lever with 1:1 Nose
7	LC0123	MD2, Lever with 10:1 Nose

<b>Code L Part Mixer Type</b>		
N	N/A	None
1	LC0063	3/16 in. (4.8 mm) x 32
2	LC0057	1/4 in. (6.4 mm) x 24
3	LC0058	3/8 in. (9.5 mm) x 24
4	LC0059	3/8 in. (9.5 mm) x 36
5	LC0060	3/8 in. (9.5 mm) Combo
6	LC0062	1/4 in. (6.4 mm) x 24 Luer Lock
7	LC0061	3/16 in. (4.8 mm) x 32 Luer Lock
8	LC0295	1/2 in. (12.7 mm) x 24
9	LC0296	1/2 in. (12.7 mm) x 36
<b>Code M Part Applicator Mounting</b>		
N	LC0294	None, Customer Mount Controls and Applicator
1	LC0292	Mast Mount, Controls & MD2 Applicator Machine Mounted
2	LC0293	Mast Mount, Controls Only
3	256439	Tank Stand Mount, Controls & MD2 Applicator Machine Mounted
4	256438	Tank Stand Mount, Controls Only
<b>Code N Part Power Cord Option</b>		
1	121055	120VAC North American Cord Set
2	121054	10A, 250V US Cord Set
3	121056	10A, 250V Continental Europe
4	121057	10A, 250V U.K./Ireland
5	121058	10A, 250V Israel
6	124864	10A, 250V Australia
7	124861	10A, 250V Italy
8	124863	10A, 250V Switzerland
9	124862	10A, 250V Denmark
A	121060	10A, 250V India
B	N/A	Heat Controller Option
<b>Code O Part Flow Monitoring</b>		
N	LC0041	None
1	257433	Pressure Transducer
2	LC0302	Two 0.5 gpm Flow Meters, No Pressure Transducers
3	LC0305	Two 1.0 gpm Flow Meters, No Pressure Transducers
4	LC0303	One 1.0 gpm Flow Meter, One 0.5 gpm Flow Meter, No Pressure Transducers
5	LC0307	Two 2.0 gpm Flow Meters, No Pressure Transducers
6	LC0306	One 2.0 gpm Flow Meter, One 1.0 gpm Flow Meter, No Pressure Transducers
7	LC0304	One 2.0 gpm Flow Meter, One 0.5 gpm Flow Meter, No Pressure Transducers
A	LC0312	Two 0.5 gpm Flow Meters, With Pressure Transducers
B	LC0315	Two 1.0 gpm Flow Meters, With Pressure Transducers

C	LC0313	One 1.0 gpm Flow Meter, One 0.5 gpm Flow Meter, With Pressure Transducers
D	LC0317	Two 2.0 gpm Flow Meters, With Pressure Transducers
E	LC0316	One 2.0 gpm Flow Meter, One 1.0 gpm Flow Meter, With Pressure Transducers
F	LC0314	One 2.0 gpm Flow Meter, One 0.5 gpm Flow Meter, With Pressure Transducers
<b>Code P Part High Volume Side Tank</b>		
N	N/A	None
1	256896	No Tanks, 1 1/2 in. npt flange
2	255241	8 L, Twin Polyethylene Tanks and Lids
3	255250	8 L, Twin Polyethylene Tanks and Lids, One 120V Agitator
4	255251	8 L, Twin Polyethylene Tanks and Lids, Two 120V Agitators
5	255281	8 L, Twin Polyethylene Tanks and Lids, with Shut-Off Valves
6	255282	8 L, Twin Polyethylene Tanks and Lids, One 120V Agitator, with Shut-Off Valves
7	255283	8 L, Twin Polyethylene Tanks and Lids, Two 120V Agitators, with Shut-Off Valves
8	LC0235★	7.5 L, Stainless Steel, High Level Sensors
9	LC0236★	7.5 L, Stainless Steel, High Level Sensors, with Shut-Off Valve
A	LC0013★	3 L, Stainless Steel
B	LC0012★	7.5 L, Stainless Steel
C	255285★	3 L, Stainless Steel, with Shut-Off Valve
D	LC0156	8 L, Twin Polyethylene Tanks and Lids, One Pneumatic Agitator
E	LC0157	8 L, Twin Polyethylene Tanks and Lids, Two Pneumatic Agitator
F	255284★	7.5 L, Stainless Steel, with Shut-Off Valve
G	LC0254★	7.5 L, Stainless Steel, 240V Heat
H	LC0255★	7.5 L, Stainless Steel, 240V Heat, with Shut-Off Valve
J	LC0054	30 L, Stainless Steel
K	LC0158	8 L, Twin Polyethylene Tanks and Lids, One Pneumatic Agitator, with Shut-Off Valves
L	LC0259	30 L, Stainless Steel, 240V Heat
M	LC0055	60 L, Stainless Steel
P	LC0159	8 L, Twin Polyethylene Tanks and Lids, Two Pneumatic Agitators, with Shut-Off Valves
R	LC0260	60 L, Stainless Steel, 240V Heat



S	LC0126	8 L, Twin Polyethylene Tanks and Lids, One 240V Agitator
T	LC0127	8 L, Twin Polyethylene Tanks and Lids, Two 240V Agitators
U	LC0128	8 L, Twin Polyethylene Tanks and Lids, One 240V Agitator, with Shut-Off Valves
V	LC0238★	7.5 L, Stainless Steel, High Level Sensors, 240V Heat, with Shut-Off Valve
W	LC0129	8 L, Twin Polyethylene Tanks and Lids, Two 240V Agitators, with Shut-Off Valves
X	LC0160	Accumulator, Fluoroelastomer
Y	LC0297	Accumulator, EP
Z	LC0237★	7.5 L, Stainless Steel, High Level Sensors, 240V Heat
---	★	When ordering tanks for spare or replacement parts, refer to <b>Parts</b> section of the PR70 and PR70v Feed Systems manual.
Code Q Part High Volume Side Tank Cover		
N	N/A	None
1	LC0018	On-Board Dust Cover
2	LC0019	On-Board Clamp Down
3	LC0020	On-Board Vacuum De-gas
4	LC0021	On-Board Agitate 120VAC 50/60 Hz
5	LC0022	On-Board Agitate 240VAC 50/60 Hz
6	LC0023	On-Board Agitate 120 VAC 50/60 Hz and De-gas
7	LC0024	On-Board Agitate 240 VAC 50/60 Hz and De-gas
8	LC0025	On-Board 120VAC 50/60 Hz, De-gas and Fill-Port
9	LC0026	On-Board 240 VAC 50/60 Hz, De-gas and Fill-Port
A	LC0142	Off-Board Clamp Down - 30L
B	LC0101	Off-Board Clamp Down - 60L
C	LC0043	Off-Board Vacuum De-gas - 30L
F	LC0102	Off-Board Vacuum De-gas - 60L
G	LC0047	Off-Board Electric Agitator - 30L
H	LC0048	Off-Board Electric Agitator - 60L
K	LC0147	Off-Board Vacuum De-gas, Pneumatic Agitator, Fill Port, Slinger - 60 L
M	LC0051	Off-Board Vacuum De-gas, Electric Agitator, Fill Port, Slinger - 30 L
R	LC0052	Off-Board Vacuum De-gas, Electric Agitator, Fill Port, Slinger - 60 L
S	LC0130	On-Board, Pneumatic Agitate
T	LC0131	On-Board, Pneumatic Agitate, De-gas





U	LC0132	On-Board, Pneumatic Agitate, De-gas, Fill Port
V	LC0142	Off-Board Pneumatic Agitator - 30 L
W	LC0143	Off-Board Pneumatic Agitator - 60 L
Z	LC0146	Off-Board Vacuum De-gas, Pneumatic Agitator, Fill Port, Slinger - 30 L
Code R Part Low Volume Side Tank		
N	N/A	None
1	256896	No Tanks, 1 1/2 in. npt flange
8	LC0235★	7.5 L, Stainless Steel, High Level Sensors
9	LC0236★	7.5 L, Stainless Steel, High Level Sensors, with Shut-Off Valve
A	LC0013★	3 L, Stainless Steel
B	LC0012★	7.5 L, Stainless Steel
C	255285★	3 L, Stainless Steel, with Shut-Off Valve
F	255284★	7.5 L, Stainless Steel, with Shut-Off Valve
G	LC0254★	7.5 L, Stainless Steel, 240V Heat
H	LC0255★	7.5 L, Stainless Steel, 240V Heat, with Shut-Off Valve
J	LC0054	30 L, Stainless Steel
L	LC0259	30 L, Stainless Steel, 240V Heat
M	LC0055	60 L, Stainless Steel
R	LC0260	60 L, Stainless Steel, 240V Heat
V	LC0238★	7.5 L, Stainless Steel, High Level Sensors, 240V Heat, with Shut-Off Valve
X	LC0160	Accumulator, Fluoroelastomer
Y	LC0297	Accumulator, EP
Z	LC0237★	7.5 L, Stainless Steel, High Level Sensors, 240V Heat
---	★	When ordering tanks for spare or replacement parts, refer to <b>Parts</b> section of the PR70 and PR70v Feed Systems manual.
Code S Part Low Volume Side Tank Covers		
N	N/A	None
1	LC0018	On-Board Dust Cover
2	LC0019	On-Board Clamp Down
3	LC0020	On-Board Vacuum De-gas
4	LC0021	On-Board Agitate 120VAC 50/60 Hz
5	LC0022	On-Board Agitate 240VAC 50/60 Hz
6	LC0023	On-Board Agitate 120 VAC 50/60 Hz and De-gas
7	LC0024	On-Board Agitate 240 VAC 50/60 Hz and De-gas
8	LC0025	On-Board 120VAC 50/60 Hz, De-gas and Fill-Port
9	LC0026	On-Board 240 VAC 50/60 Hz, De-gas and Fill-Port

A	LC0142	Off-Board Clamp Down - 30L
B	LC0101	Off-Board Clamp Down - 60L
C	LC0043	Off-Board Vacuum De-gas - 30L
F	LC0102	Off-Board Vacuum De-gas - 60L
G	LC0047	Off-Board Electric Agitator - 30L
H	LC0048	Off-Board Electric Agitator - 60L
K	LC0147	Off-Board Vacuum De-gas, Pneumatic Agitator, Fill Port, Slinger - 60 L
M	LC0051	Off-Board Vacuum De-gas, Electric Agitator, Fill Port, Slinger - 30 L
R	LC0052	Off-Board Vacuum De-gas, Electric Agitator, Fill Port, Slinger - 60 L
S	LC0130	On-Board, Pneumatic Agitate
T	LC0131	On-Board, Pneumatic Agitate, De-gas
U	LC0132	On-Board, Pneumatic Agitate, De-gas, Fill Port
V	LC0142	Off-Board Pneumatic Agitator - 30 L
W	LC0143	Off-Board Pneumatic Agitator - 60 L
Z	LC0146	Off-Board Vacuum De-gas, Pneumatic Agitator, Fill Port, Slinger - 30 L
Code T	Part	Tank Level Sensors
N	N/A	None
2	LC0278	Polyethylene Tanks - Low Level Sensors Only
3	LC0279	Two 7.5 L Stainless Steel Tanks - Low Level Sensors Only
4	LC0282	Two 30 L or 60 L Stainless Steel Tanks - Low Level Sensors Only
5	LC0281	7.5 L Stainless Steel - Low Level Sensors Only, and 30 L or 60 L Stainless Steel - Low Level Sensors Only
6	LC0280	Accumulator Sensors, and 7.5 L Low Level Sensors
7	LC0283	Accumulator Sensors, and 30 L or 60 L Low Level Sensors
9	LC0284	Two 7.5 L Stainless Steel Tanks - High and Low Level Sensors with Refill Logic
A	LC0287	Two 30 L or 60 L Stainless Steel Tanks - High and Low Level Sensors with Refill Logic
B	LC0286	7.5 L Stainless Steel - Low Level Sensors, and 30 L or 60 L Stainless Steel - High and Low Level Sensors with Refill Logic
C	LC0289	7.5 L Stainless Steel - High and Low Level Sensors with Refill Logic, and 30 L or 60 L Stainless Steel - High and Low Level Sensors with Refill Logic
D	LC0285	Accumulator Sensors, and 7.5 L High and Low Level Sensors
E	LC0288	Accumulator Sensors, and 30 L or 60 L High and Low Level Sensors
G	N/A	Two Sets of Accumulator Sensors





Code U	Part	Heat Zone Controller
N	N/A	None
C	LC0250	1 Tank or 1 Hose
D	LC0251	2 Tanks, 1 Tank and 1 Hose, or 2 Hoses
E	LC0252	2 Tanks and 1 Hose, or 1 Tank and 2 Hoses
F	LC0253	2 Tanks and 2 Hoses
Code V	Part	Off-Board Tank Stands
N	N/A	None
2	LC0103	PR70 Tank Stand
3	LC0247	PR70v Tank Stand

# Warnings

The following warnings are for the setup, use, grounding, maintenance, and repair of this equipment. The exclamation point symbol alerts you to a general warning and the hazard symbol refers to procedure-specific risk. Refer back to these warnings. Additional, product-specific warnings may be found throughout the body of this manual where applicable.

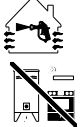
 <b>WARNING</b>	
	<p><b>ELECTRIC SHOCK HAZARD</b></p> <p>Improper grounding, setup, or usage of the system can cause electric shock.</p> <ul style="list-style-type: none"> <li>• Turn off and disconnect power cord before servicing equipment.</li> <li>• Use only grounded electrical outlets.</li> <li>• Use only 3-wire extension cords.</li> <li>• Ensure ground prongs are intact on power and extension cords.</li> <li>• Do not expose to rain. Store indoors.</li> </ul>
	<p><b>SKIN INJECTION HAZARD</b></p> <p>High-pressure fluid from dispense valve, hose leaks, or ruptured components will pierce skin. This may look like just a cut, but it is a serious injury that can result in amputation. <b>Get immediate surgical treatment.</b></p> <ul style="list-style-type: none"> <li>• Do not point dispense valve at anyone or at any part of the body.</li> <li>• Do not put your hand over the end of the dispense nozzle.</li> <li>• Do not stop or deflect leaks with your hand, body, glove, or rag.</li> <li>• Follow <b>Pressure Relief Procedure</b> in this manual, when you stop spraying and before cleaning, checking, or servicing equipment.</li> </ul>
	<p><b>TOXIC FLUID OR FUMES HAZARD</b></p> <p>Toxic fluids or fumes can cause serious injury or death if splashed in the eyes or on skin, inhaled, or swallowed.</p> <ul style="list-style-type: none"> <li>• Read MSDS's to know the specific hazards of the fluids you are using.</li> <li>• Store hazardous fluid in approved containers, and dispose of it according to applicable guidelines.</li> <li>• Always wear impervious gloves when spraying or cleaning equipment.</li> </ul>
	<p><b>PERSONAL PROTECTIVE EQUIPMENT</b></p> <p>You must wear appropriate protective equipment when operating, servicing, or when in the operating area of the equipment to help protect you from serious injury, including eye injury, inhalation of toxic fumes, burns, and hearing loss. This equipment includes but is not limited to:</p> <ul style="list-style-type: none"> <li>• Protective eyewear</li> <li>• Clothing and respirator as recommended by the fluid and solvent manufacturer</li> <li>• Gloves</li> <li>• Hearing protection</li> </ul>

**WARNING**

 	<p><b>FIRE AND EXPLOSION HAZARD</b></p> <p>Flammable fumes, such as solvent and paint fumes, in work area can ignite or explode. To help prevent fire and explosion:</p> <ul style="list-style-type: none"> <li>• Use equipment only in well ventilated area.</li> <li>• Eliminate all ignition sources; such as pilot lights, cigarettes, portable electric lamps, and plastic drop cloths (potential static arc).</li> <li>• Keep work area free of debris, including solvent, rags and gasoline.</li> <li>• Do not plug or unplug power cords or turn lights on or off when flammable fumes are present.</li> <li>• Ground all equipment in the work area. See <b>Grounding</b> instructions.</li> <li>• If there is static sparking or you feel a shock, <b>stop operation immediately</b>. Do not use equipment until you identify and correct the problem.</li> <li>• Keep a working fire extinguisher in the work area.</li> </ul>
	<p><b>EQUIPMENT MISUSE HAZARD</b></p> <p>Misuse can cause death or serious injury.</p> <ul style="list-style-type: none"> <li>• Do not operate the unit when fatigued or under the influence of drugs or alcohol.</li> <li>• Do not exceed the maximum working pressure or temperature rating of the lowest rated system component. See <b>Technical Data</b> in all equipment manuals.</li> <li>• Use fluids and solvents that are compatible with equipment wetted parts. See <b>Technical Data</b> in all equipment manuals. Read fluid and solvent manufacturer's warnings. For complete information about your material, request MSDS forms from distributor or retailer.</li> <li>• Check equipment daily. Repair or replace worn or damaged parts immediately with genuine manufacturer's replacement parts only.</li> <li>• Do not alter or modify equipment.</li> <li>• Use equipment only for its intended purpose. Call your distributor for information.</li> <li>• Route hoses and cables away from traffic areas, sharp edges, moving parts, and hot surfaces.</li> <li>• Do not kink or over bend hoses or use hoses to pull equipment.</li> <li>• Keep children and animals away from work area.</li> <li>• Comply with all applicable safety regulations.</li> </ul>
	<p><b>MOVING PARTS HAZARD</b></p> <p>Moving parts can pinch or amputate fingers and other body parts.</p> <ul style="list-style-type: none"> <li>• Keep clear of moving parts.</li> <li>• Do not operate equipment with protective guards or covers removed.</li> <li>• Pressurized equipment can start without warning. Before checking, moving, or servicing equipment, follow the <b>Pressure Relief Procedure</b> in this manual. Disconnect power or air supply.</li> </ul>
	<p><b>BURN HAZARD</b></p> <p>Equipment surfaces and fluid that's heated can become very hot during operation. To avoid severe burns, do not touch hot fluid or equipment. Wait until equipment/fluid has cooled completely.</p>

## Moisture Sensitivity of Isocyanates

Isocyanates (ISO) are catalysts used in two component foam and polyurea coatings. ISO will react with moisture (such as humidity) to form small, hard, abrasive crystals, which become suspended in the fluid. Eventually a film will form on the surface and the ISO will begin to gel, increasing in viscosity. If used, this partially cured ISO will reduce performance and the life of all wetted parts.

**NOTE:** The amount of film formation and rate of crystallization varies depending on the blend of ISO, the humidity, and the temperature.

To prevent exposing ISO to moisture:

- Always use a sealed container with a desiccant dryer in the vent, or a nitrogen atmosphere. **Never** store ISO in an open container.
- The PR70 has exposed shafts, so extra precautions must be taken when using ISO Materials. Make sure that the shafts are wiped clean and lubricated if sitting unused for any length of time, such as overnight shutdowns. The lubricant creates a barrier between the ISO and the atmosphere. Evaluate your system and follow this procedure more often if necessary.
- Use moisture-proof hoses specifically designed for ISO, such as those supplied with your system.
- Never use reclaimed solvents, which may contain moisture. Always keep solvent containers closed when not in use.
- Never use solvent on one side if it has been contaminated from the other side.
- Always lubricate threaded parts with ISO pump oil or grease when reassembling.

# Component Identification

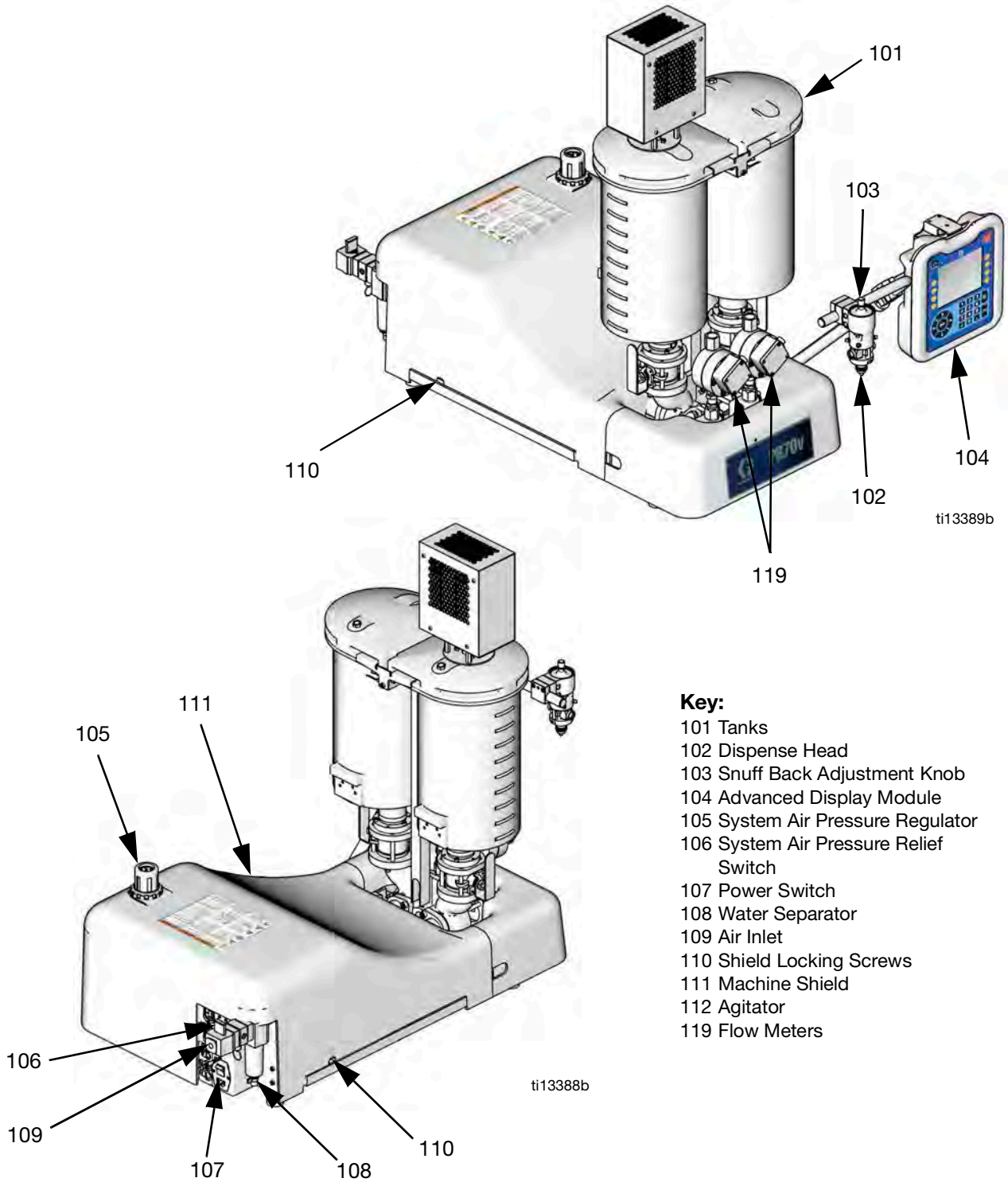
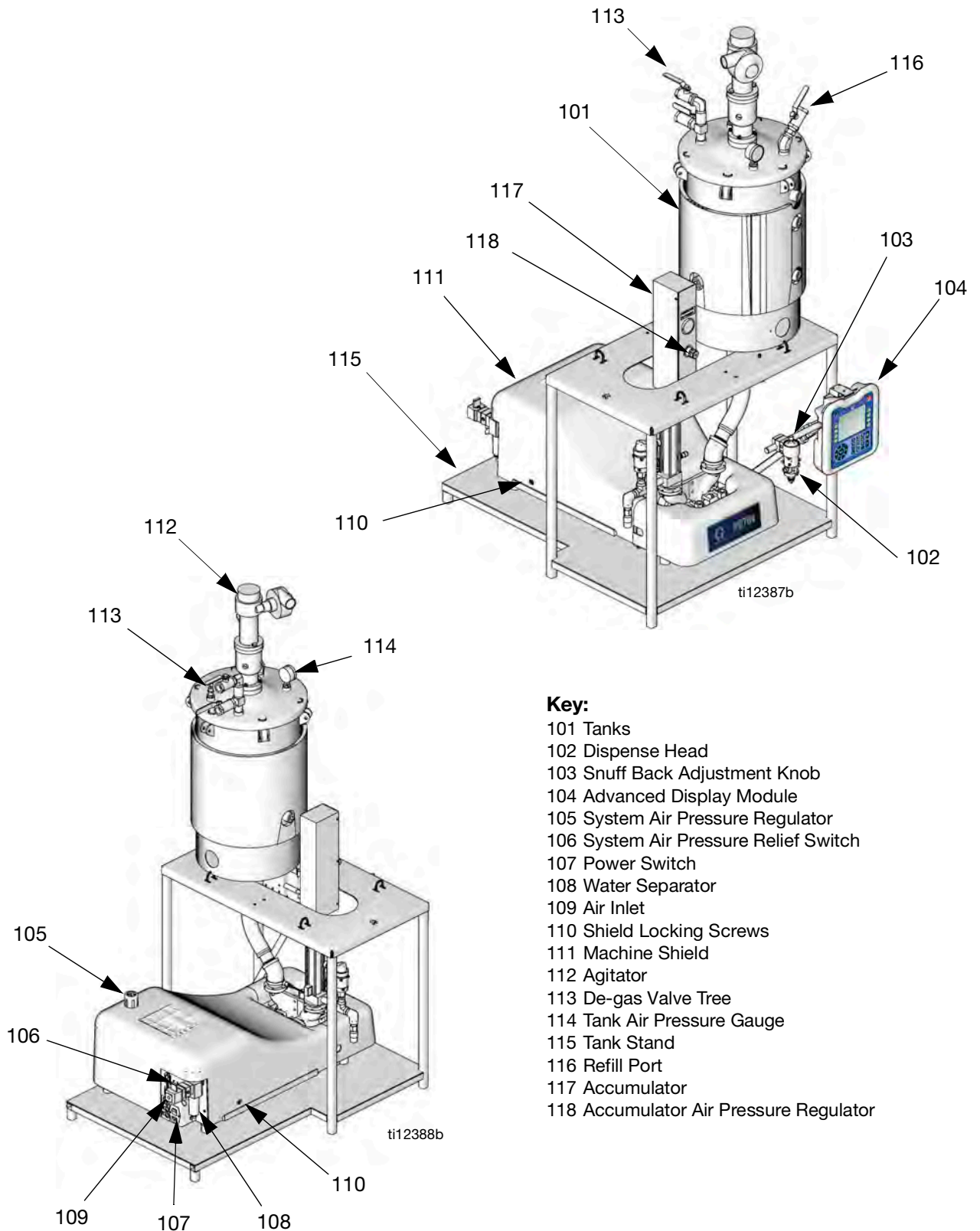



FIG. 1:PR70v with On-Board Tanks and Other Options



**FIG. 2: PR70v with Off-Board Tank, Accumulator, and Other Options**

## Advanced Display Module (ADM)

 If an invalid key is pressed, the Advanced Display Module will sound three quick beeps to notify the user.

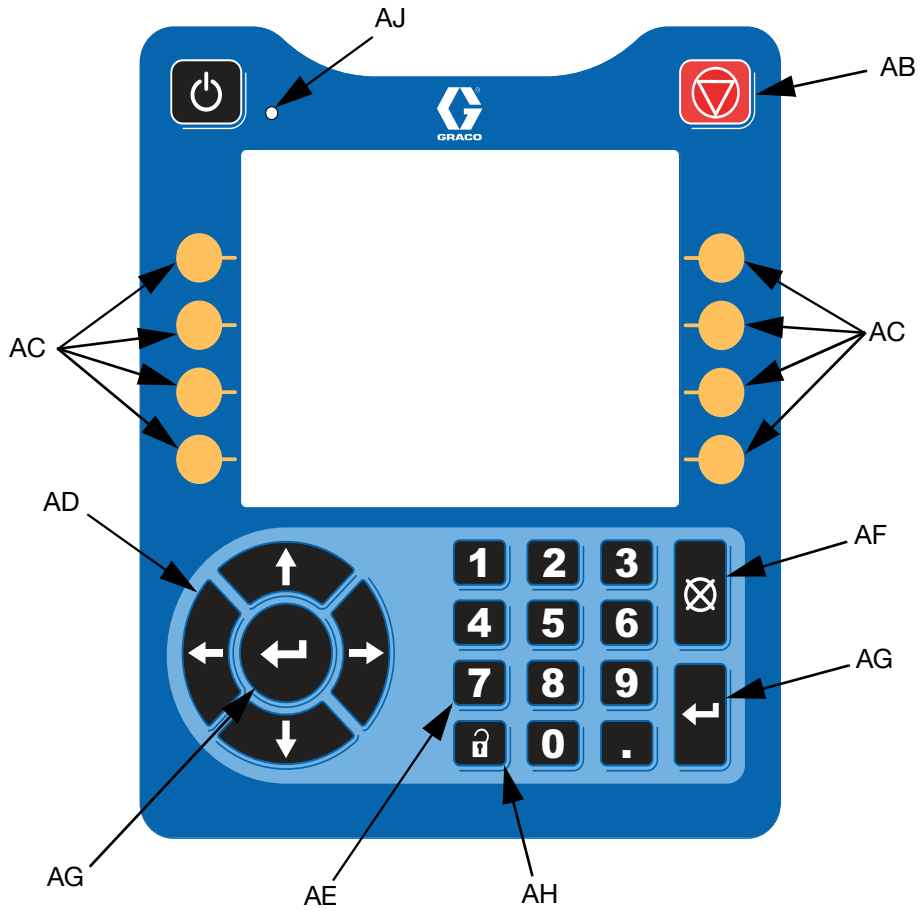

**Key:**

- AB Machine Disable Mode Key
- AC Soft Keys
- AD Directional Keypad
- AE Numeric Keypad
- AF Abort/Cancel Key
- AG Enter Key
- AH Alternate Setup/Operation Screens
- AJ Module Status LED

FIG. 3

### Module Status LED Diagnostics

State	Description
Solid Green	System enabled, valid mode selected
Flashing Yellow	System disabled (setup screens)
Solid Yellow	System disabled (operation screens)



# Screen Navigation Diagram

The black arrows in the diagram denote which arrow on the directional keypad to press to move to the respective screen.

If the password is enabled, the password will need to be entered to access the Setup screens. Use the numeric keypad to enter the password then press the Enter button (↵).

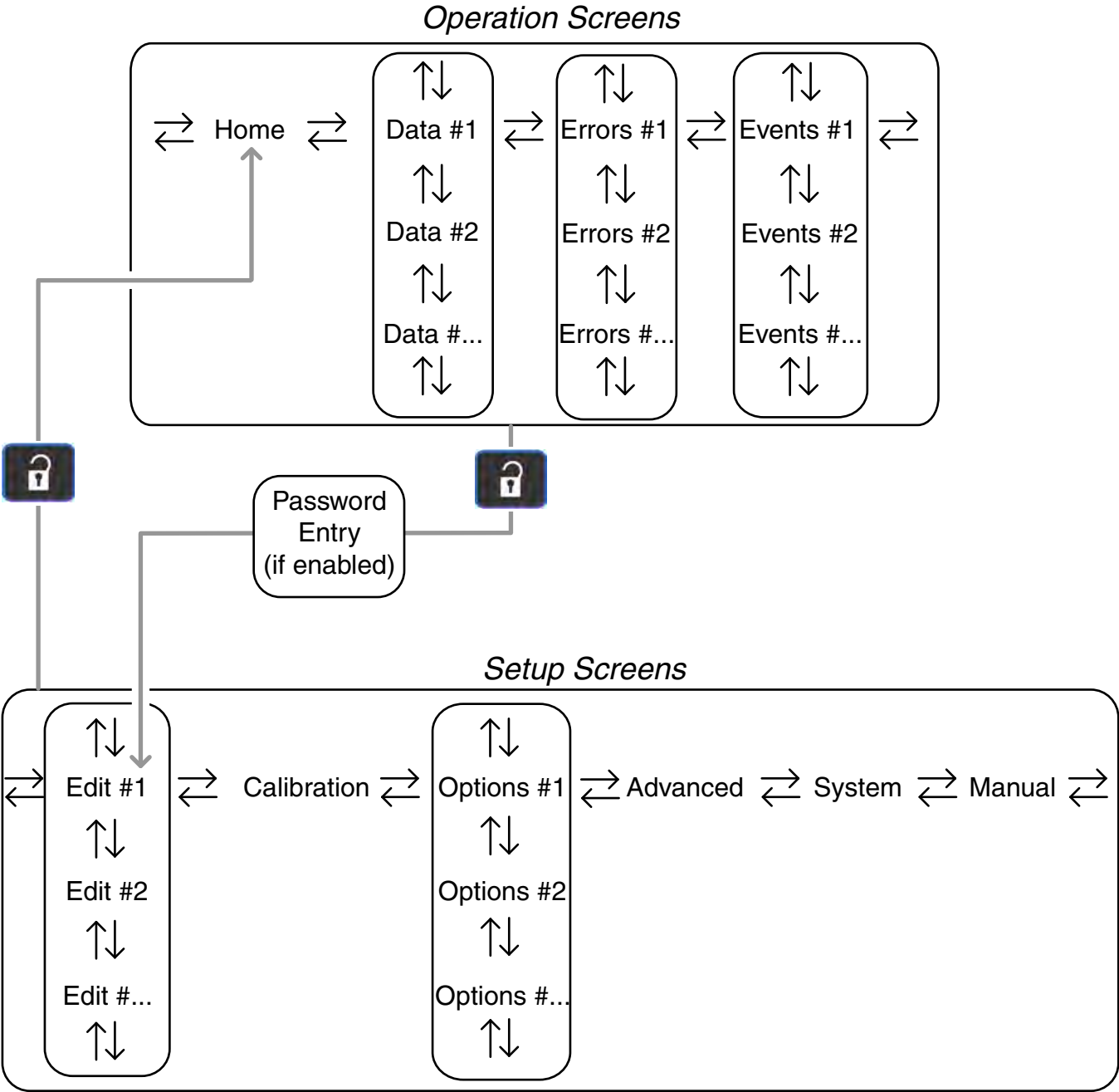

# Grounding

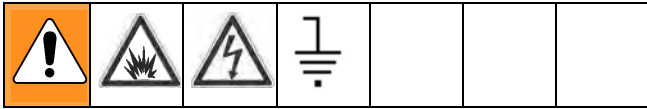

This product must be grounded. In the event of an electrical short circuit, grounding reduces the risk of electric shock by providing an escape wire for the electric current. This product is equipped with a cord having a grounding wire with an appropriate grounding plug. The plug must be plugged into an outlet that is properly installed and grounded in accordance with all local codes and ordinances.

Improper installation of the grounding plug is able to result in a risk of electric shock. When repair or replacement of the cord or plug is required, do not connect the grounding wire to either flat blade terminal. The wire with insulation having an outer surface that is green with or without yellow stripes is the grounding wire. Do not modify the plug provided; if it does not fit the outlet, have the proper outlet installed by a qualified electrician. Only connect the product to an outlet having the same configuration as the plug. Do not use an adapter with this product.

# Installation



Avoid contact with electrical inter-connects when connecting electric power to the machine. Avoid contact with Krytox on the pump shaft, PE tank lid, and PE tank lid gasket. Contact with Krytox causes flu-like symptoms. Read all manufacturer's warning and material MSDS to know the specific hazards of the material used.

# Machine Installation

**CAUTION**

Do not lift the machine by the tanks.

## Locate Machine

1. Locate a bench top or open floor area to mechanically mount the machine. Ensure the location has

access to compressed air and AC power and is well ventilated.

2. Place the machine on the designated location. Allow the machine to rest on the rubber feet provided.

## Mount Machine, if Needed

3. Remove the shield locking screws (110) on both sides then remove the protective shield.
4. Attach the frame to the selected location by installing fasteners (not provided with unit) through the four mounting holes. See FIG. 4.

*Variable Ratio*

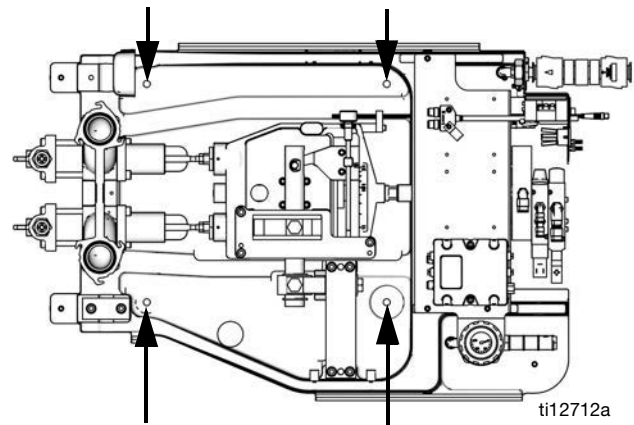

*Fixed Ratio*

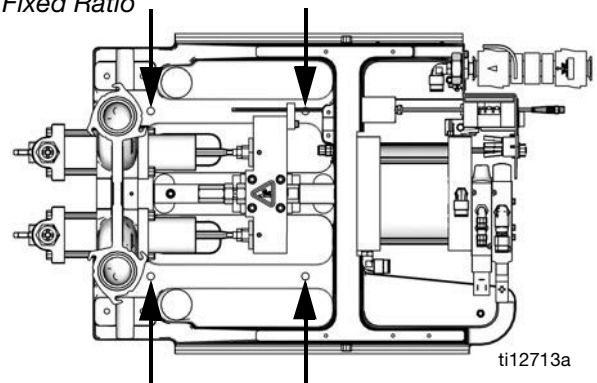



**FIG. 4: Mounting Holes**

## Connect Pressurized Air Input





5. Connect a compressed airline to the air inlet (109) in the back of the machine.

**Electrical Requirements**

						
<p>Improper wiring may cause electric shock or other serious injury if work is not performed properly. Have a qualified electrician perform any electrical work. Be sure your installation complies with all National, State and Local safety and fire codes.</p>						

- Using the power cord provided, connect AC power (100-240V, 50/60 Hz, single-phase) to the machine.

**Ground System**

						
---	---	---	---	--	--	--

The equipment must be grounded. Grounding reduces the risk of static and electric shock by providing an escape wire for the electrical current due to static build up or in the event of a short circuit.

- The machine is grounded through the power cord.
  - Be sure that the plug is plugged into an outlet that is properly installed and grounded in accordance with all local codes and ordinances.
  - Only connect the product to an outlet having the same configuration as the plug.

**Flush the System**

- The machine is tested at the factory with mineral oil. Flush the machine before first use.

## Tank Refill Kit 256577 Installation

The tank refill kit is shipped uninstalled. The tank refill kit can be installed on the lid of the tank or on the side of the tank. See FIG. 5 and FIG. 7.

Install the tank refill kit in the tank lid if using heat or agitation or if a slinger blade is installed in the tank. Install the tank refill kit in the side of the tank if using thicker materials. Pouring thick materials into the tank from the lid can result in air added to the material. For all other applications, install the tank refill kit in either location.

### Tank Refill Kit Lid Installation

1. Use PTFE tape and the fittings supplied to install the refill kit. See FIG. 5.

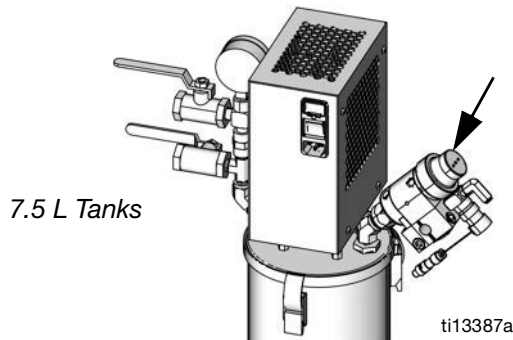
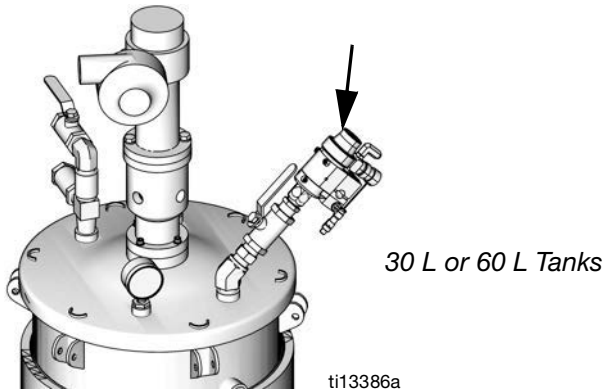

**FIG. 5: Tank Lid Installation**

2. For tank refill kits installed on the A side tank, plug the tank refill kit power cord into the “A” connector located at the back of the machine. See FIG. 6.  
For tank refill kits installed on the B side tank, plug the tank refill kit power cord into the “B” connector located at the back of the machine. See FIG. 6.

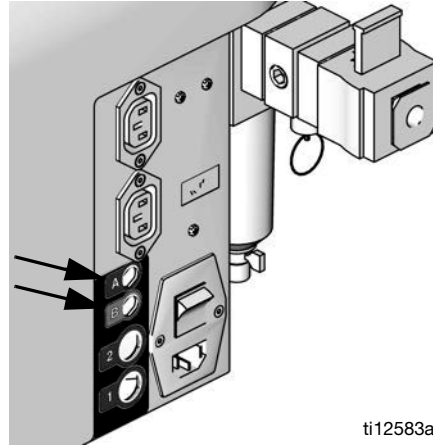

**FIG. 6: Tank Refill Kit Power Source**

### Tank Refill Kit Side Installation

1. Use PTFE tape and the fittings supplied to install the refill kit as shown in FIG. 7.

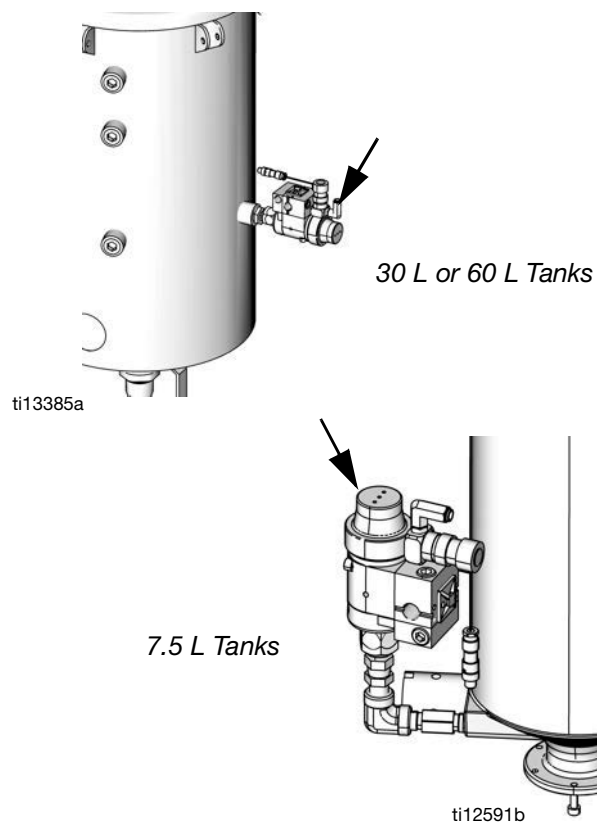

**FIG. 7: Side Installation**

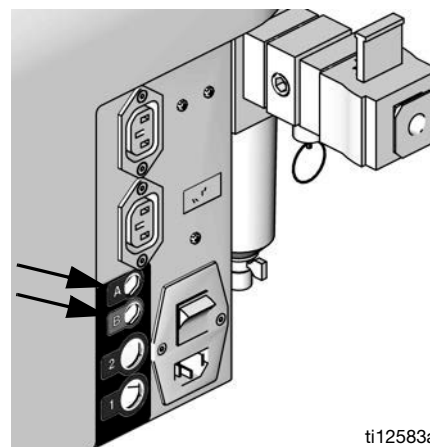

2. For tank refill kits installed on the A side tank, plug the tank refill kit power cord into the “A” connector located at the back of the machine. See FIG. 8.  
For tank refill kits installed on the B side tank, plug the tank refill kit power cord into the “B” connector located at the back of the machine. See FIG. 8.

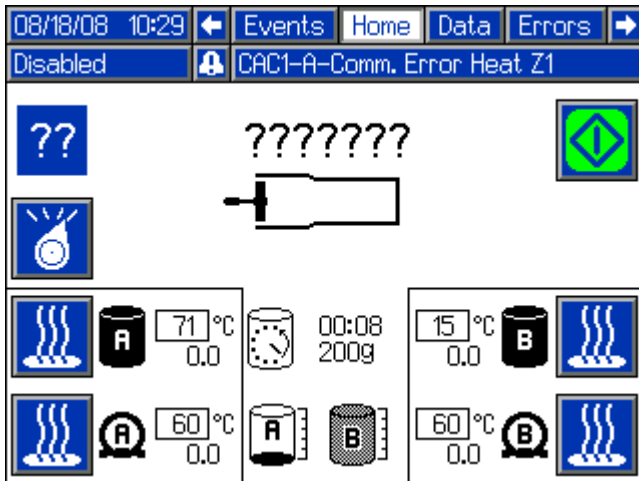

**FIG. 8: Tank Refill Kit Power Source**

# Startup



1. Locate power switch (107) at rear of machine and turn power on. The display module will automatically turn on and begin to load.
2. Slide the system air pressure relief switch (106) up. It is the yellow tab at the left, rear of the machine. The hole in the tab should not be showing.
3. If the machine is in Disabled Mode, press the Select Operating Mode button (  ) repeatedly to exit Disabled mode and to select a new operating mode. Press the Enter button (  ) to accept the new operating mode.



**FIG. 9: Disabled Mode**

# Setup



## Setup Screens

### Edit Screens

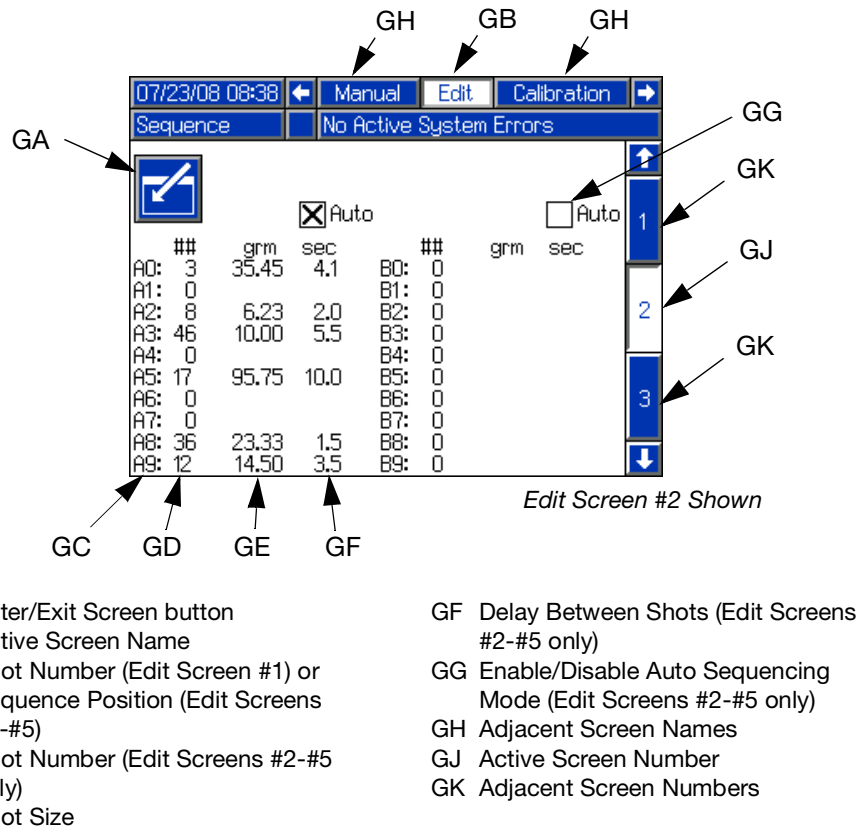

FIG. 10

### Enter/Exit Screen Button

Many screens use the Enter/Exit Screen button (GA). When scrolling through screens using the arrow keys, the information in each screen can be seen but not changed. To change the information in a screen that has the Enter/Exit Screen button (GA), first press the Enter/Exit Screen button to enter the screen. Once in the screen, use the arrow keys to navigate and use the arrow keys, number keys, and enter key as applicable to change the values.

## Overview

There are five Edit screens. Edit Screen #1 is the Shot Editing screen and Edit Screens #2-#5 are Sequence Editing screens. Edit Screen #1 shows Shot #1 through Shot #50. Each shot has a defined shot size that is measured in grams.

Edit Screens #2-#5 show Sequence A through Sequence G. Each sequence has ten positions; shown as A0 to A9 in FIG. 10. Each of the ten positions in the sequence uses one of the Shot Numbers (GD) defined in Edit Screen #1. The third column in FIG. 10 shows the shot sizes (GE) for the selected Shot Numbers.

When operating in Sequence mode and a shot in the sequence is finished, the machine will automatically select the next position in the sequence that uses a Shot Number with a non-zero shot size.

When operating in Sequence mode, there is an option to allow the machine to automatically perform all of the shots in the sequence with a preset delay between shots. The delay between Shots (GF) is shown in the fourth column. This process is called Auto-Sequencing.

## Edit Shot Size

To edit the defined shot size (GE) for a certain shot number using Edit Screen #1, use the following procedure.

1. Navigate to the Edit Screen #1. See **Screen Navigation Diagram**, page 17.
2. Press the Enter/Exit Screen button (GA) to enter the screen.
3. Use the arrow keys to navigate to the shot size for the Shot Number to be changed.
4. Use the numeric keypad to enter the desired shot size in grams.
5. Press the Enter button () to accept the shot size and exit editing mode.
6. Press the Enter/Exit Screen button (GA) to exit the screen.

## Edit Shot Sequence

To change which Shot Numbers (GD) from Edit Screen #1 are used in a sequence, use the following procedure.

1. Navigate to the Edit Screen that contains the Sequence to be changed. See the list below, then see **Screen Navigation Diagram**, page 17.
  - Sequences A and B are on Edit Screen #2
  - Sequences C and D are on Edit Screen #3
  - Sequences E and F are on Edit Screen #4
  - Sequence G is on Edit Screen #5
2. Press the Enter/Exit Screen button (GA) to enter the screen.

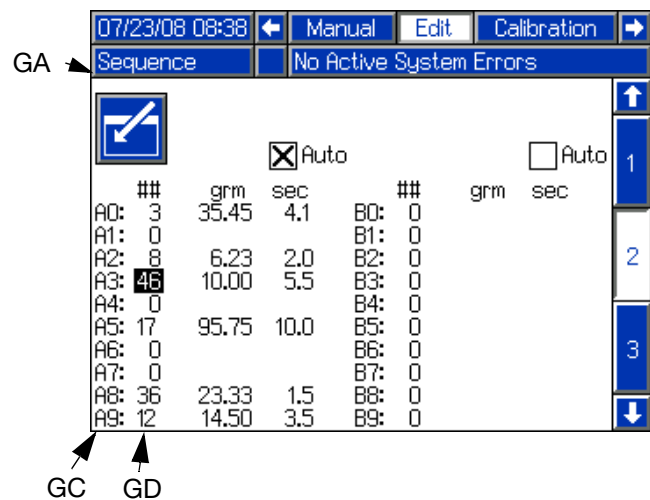





FIG. 11: Edit Shot Number in Sequence

3. Each Sequence Position (GC) uses a Shot Number (GD). Use the arrow keys to navigate to the Shot Number for the sequence position to be changed.
4. Press the Enter button () to enter editing mode.
5. Use the Up Arrow button () or the Down Arrow button () to change the Shot Number.

 Only Shot Numbers with non-zero shot sizes will be available for selection.

6. Press the Enter button () to accept the Shot Number and exit editing mode.



7. Press the Enter/Exit Screen button (GA) to exit the screen.

### Edit Auto-Sequencing

To edit whether the machine automatically performs all shots in a sequence, use the following procedure.

1. Navigate to the Edit Screen that contains the Sequence to be changed. See **Screen Navigation Diagram**, page 17.
2. Press the Enter/Exit Screen button (GA) to enter the screen.

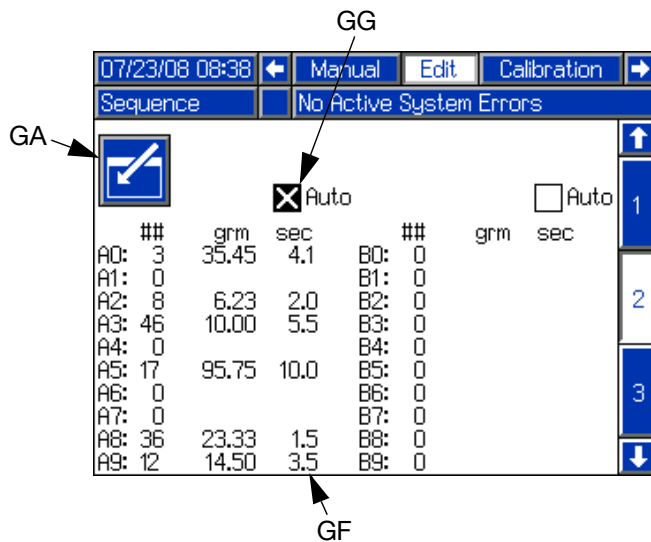

**FIG. 12: Turn Auto-Sequencing On/Off**

3. Use the arrow keys to navigate to the Enable/Disable Auto Sequencing Mode (GG) box for the sequence position to be changed.
4. Press the Enter button (↵) to add or remove the "X" from the box.
5. Navigate away from the Enable/Disable Auto Sequencing Mode (GG) box to accept the change.
6. If Auto-Sequencing is enabled, the delay between shots can be changed.
  - a. Navigate to the delay between shots (GF) for the Sequence Position to be changed.

 The delay shown in a given Sequence Position row is the delay prior to beginning the next shot in the sequence.

- b. Use the numeric keypad to enter the desired delay time in seconds.
  - c. Press the Enter button (↵) to accept the delay and exit editing mode.
7. Press the Enter/Exit Screen button (GA) to exit the screen.

## Calibration Screen

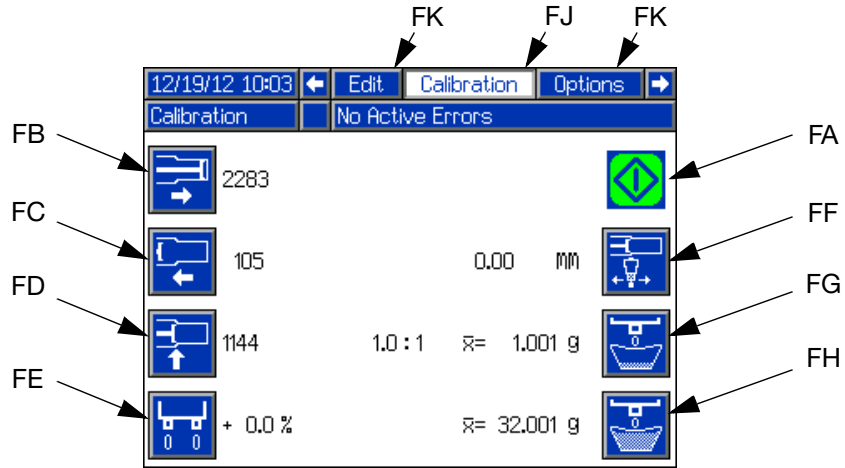

**Key:**

- |                                     |                                      |
|-------------------------------------|--------------------------------------|
| FA Start/Stop Shot                  | FF Adjust Open Dispense Valve Timing |
| FB Update Piston Extended Position  | FG Initiate Small Calibration Shot   |
| FC Update Piston Retracted Position | FH Initiate Large Calibration Shot   |
| FD Update Piston Engaged Position   | FJ Active Screen Name                |
| FE Piston Phasing                   | FK Adjacent Screen Names             |

**FIG. 13**

See **Piston Position Calibration** on page 37, **Phasing Adjustment** on page 40, **Adjust Open Dispense Valve (ODV) Timing** on page 43, and **Shot Calibration** on page 47 for Calibration Screen use.

## Options Screens

### Fluid Options, Screen #1

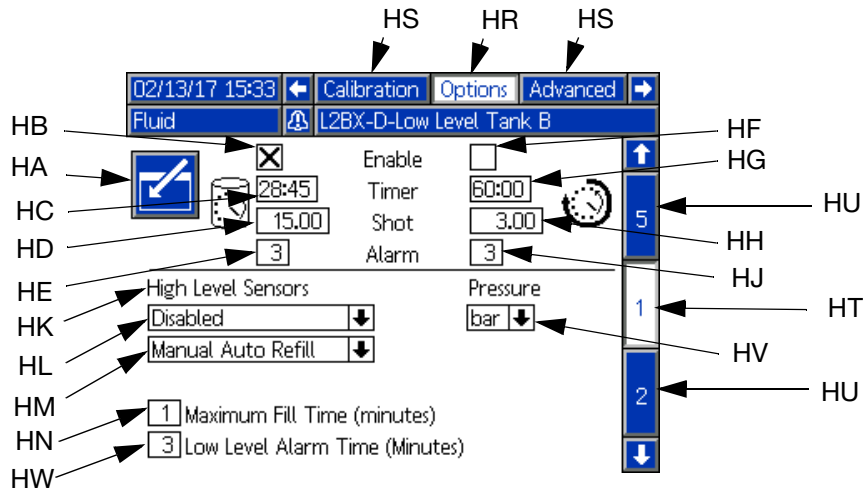

**Key:**

- HA Enter/Exit Screen
- HB Purge Timer Enable/Disable
- HC Purge Timer Delay
- HD Purge Timer Shot Size
- HE Purge Timer Alarm (seconds)
- HF Recirculation Timer Enable/Disable
- HG Recirculation Timer Delay
- HH Recirculation Timer Shot Size
- HJ Recirculation Timer Alarm (seconds)
- HK Low Level Sensors Enable/Disable (For FCMB Systems)
- HL Tank A High Level Sensor Options
- HM Tank B High Level Sensor Options
- HN Maximum Fill Time
- HR Active Screen Name
- HS Adjacent Screen Names
- HT Active Screen Number
- HU Adjacent Screen Numbers
- HV Pressure Units of Measure Selection
- HW Low Level Alarm Time

FIG. 14

### Recirculation and Purge Timers

To use Recirculation mode, 3-way ball valves must be installed at the dispense head. Fluid lines must be installed going from the ball valves back to the tank.

The Purge Timer and Recirculation Timer behave in a similar way, with a certain shot size (HD, HH) being executed after the timer delay (HC, HG) has elapsed. The difference is that the purge timer operates with the dispense valve open so a purge shot is executed. The recirculation timer operates with the dispense valve closed so when the shot is executed no material is dispensed.

When Recirculation mode is enabled, both recirculation ball valves must be turned to return material back to the tank. Only turning one valve may result in a pressure imbalance exceeding the machine's maximum working pressure.

Both timers feature an adjustable alarm to warn the user that the piston drive block is to begin moving. The alarm setting is the number of seconds before the shot is to be executed.

## Level Sensors

 See the Feed Systems manual referenced at the beginning of this manual for Vacuum Auto-Fill procedure.

The Low Level Sensors can be enabled or disabled. Disabling the low level sensors disables low level alarms. If the Low Level Sensors are disabled, the tank icons on the Home screen will be grayed out.

With High Level Sensors installed, auto-Refill can be used. The High Level Sensors have multiple Auto-Refill modes ranging in function.

- **High Level Auto-Refill** refills the tank when material is below the high level sensor. This mode is recommended for applications with temperature control.
- **Empty Auto-Refill** refills the tank when a low level condition is seen.
- **Manual Auto-Refill** requires the user to initiate tank refill.
- **Monitor High Level** mode simply displays the current fluid level on the Home screen. This selection should be chosen only if low level sensors are installed for the respective tank.
- **Accumulator** mode refills the accumulators automatically when a low level condition is seen.

## Maximum Fill Time

The Maximum Fill Time (HN) function allows the user to specify a maximum amount of time for refilling the tank. If after the input amount of time the tanks are not full, an alarm will be displayed.

## Enable/Disable Timers and Low Level Sensors



1. Press the Enter/Exit Screen button (HA).
2. Use the arrow keys to navigate to the item to be changed.
3. Press the Enter button () to enable or disable the selected item.

## Edit Numeric Values

1. Press the Enter/Exit Screen button (GA) to enter the screen.

2. Use the arrow keys to navigate to the item to be changed.
3. Use the numeric keypad to enter the new value.
4. Press the Enter button () to accept the new value.
5. Press the Enter/Exit Screen button (GA) to enter the screen.

## Edit High Level Sensor Drop-Down Boxes

1. Press the Enter/Exit Screen button (GA) to enter the screen.
2. Use the arrow keys to navigate to the item to be changed.
3. Press the Enter button () to open the drop-down menu.
4. Use the up and down arrow keys to select the new value.
5. Press the Enter button () to accept the new value.
6. Press the Enter/Exit Screen button (GA) to enter the screen.

## Low Level Alarm Time

The Low Level Alarm Time (HW) function allows the user to delay the generation of a low level alarm for 0 (default) to 5 minutes. If a non-zero value is entered and a low level tank alarm is generated, dispensing will be disabled until the tank is filled or the machine is cycled.

Heat Options, Screen #2

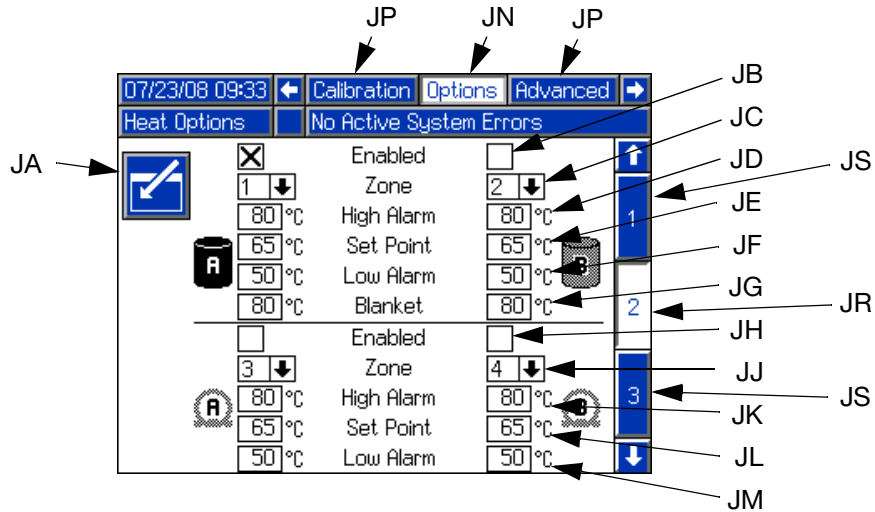

Key:

- JA Enter/Exit Screen
- JB Enable/Disable Tank Heater Zone
- JC Zone Number Used for Tank Heat Control
- JD Tank Heat High Temperature Alarm
- JE Tank Heat Temperature Setpoint
- JF Tank Heat Low Temperature Alarm
- JG Tank Heat Blanket Temperature Setpoint
- JH Enable/Disable Hose Heater Zone
- JJ Zone Number Used for Hose Heater Control
- JK Hose Heater High Temperature Alarm
- JL Hose Heater Temperature Setpoint
- JM Hose Heater Low Temperature Alarm
- JN Active Screen Name
- JP Adjacent Screen Names
- JR Active Screen Number
- JS Adjacent Screen Numbers

FIG. 15

The Heat Options Setup Screen includes options for the tank and hose heaters. Each tank and hose heater can be enabled and disabled and each have their own settings.

Zone Numbers

Each tank and hose heater is assigned to a specific “zone” number. The zone number refers to the zone number on the Integrated Heat Assembly. Each zone number has a label above it. See Fig. 16.

The zone number specified for each option on the Heat Options Setup Screen needs to match how the system is connected. For instance, if tank A is connected to zone #1, then zone #1 needs to be selected for tank A heat.

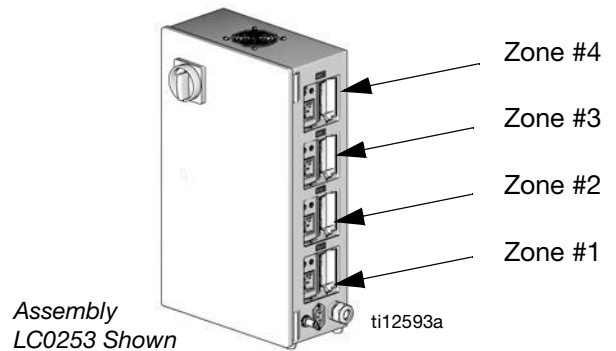

FIG. 16: Integrated Heat Assembly, Zone Numbers

Temperature Settings

Each tank and hose heater has a high and low temperature alarm and a temperature setpoint. The tanks also have a blanket heater temperature setpoint.

An alarm will sound when the material temperature is outside of the range given by the high and low temperature setpoints. also, dispensing may be disabled depending on the selections made in the System Options Setup Screen, see page 31.

### Enable/Disable Heat Options

All heat options can be enabled or disabled. All options that are installed should be enabled and all that are not installed should be disabled. All enabled heat options can be turned on and off from the Home Screen, see page 54. To enable or disable heat options, perform the following procedure.





1. Press the Enter/Exit Screen button (JA).
2. Use the arrow keys to navigate to the item to be changed.
3. Press the Enter button () to enable or disable the selected item.
4. Navigate away from the Enable/Disable field to accept the change.

### Change Zone Number

To change a zone number, the applicable tank or hose heater must be disabled.

1. Press the Enter/Exit Screen button (JA).
2. Disable all heat options that will have their zone number changed.
3. Change zone number for all heat options just disabled.

 No two zones may have the same zone number assigned at any point. To change a heat option zone number to a zone number already assigned to another heat option, the existing assignment must first be changed to either another zone number or "--".

- a. Use the arrow keys to navigate to the Heat Option Zone field (JC, JJ).
- b. Press the Enter button () to enter editing mode.
- c. Use the Up Arrow button () or the Down Arrow button () to change the item value.
- d. Press the Enter button () to exit editing mode.

### Edit Temperature Settings

1. Press the Enter/Exit Screen button (JA) to enter the screen.
2. Use the arrow keys to navigate to the item to be changed.
3. Use the numeric keypad to enter the desired temperature in the displayed units (Celsius or Fahrenheit).
4. Press the Enter button () to accept the new value and exit editing mode.
5. Press the Enter/Exit Screen button (JA) to exit the screen.

## System Options, Screen #3

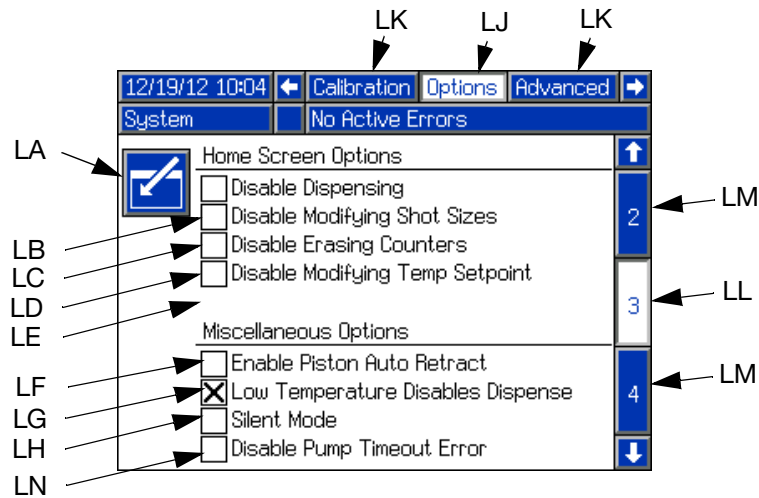
**Key:**

LA	Enter/Exit Screen	LH	Silent Mode Option
LB	Disable Dispensing Option	LJ	Active Screen Name
LC	Disable Modifying Shot Sizes Option	LK	Adjacent Screen Names
LD	Disable Erasing Counters Option	LL	Active Screen Number
LE	Disable Changing Temperature Setpoint Option	LM	Adjacent Screen Numbers
LF	Enable Piston Auto-Retract Option	LN	Disables Pump Stationary During Dispense Timeout Error
LG	Low Temperature Disables Dispense Option		

FIG. 17

**Primary Run Screen Options**

These options disable certain functions on the Home Screen. Some of the functions can be performed using the setup screens. When using these options, it is recommended that the Setup screens are protected by a password; see **Advanced Setup Screen**, page 34.

- **Disable Dispensing** disables dispensing from the Home screen.
- **Disable Modifying Shot Sizes** disables editing shot size definitions from the Home screen.
- **Disable Erasing Counters** disables erasing shot counters on the Data screen.
- **Disable Changing Temperature Setpoint** disables changing the temperature setpoint from the Home screen.

**Miscellaneous Options**

- **Enable Piston Auto Retract** enables the piston to automatically retract after every shot when in Operator (Manual) mode. Normally the piston only retracts after it completes the entire stroke.

- **Low Temperature Disables Dispense** disables dispensing if the material temperature is below the low temperature setpoint.
- **Silent Mode** disables all audible alerts.

**Enable/Disable Options**

1. Press the Enter/Exit Screen button (LA) to enter the screen.
2. Use the arrow keys to navigate to the item to be changed.
3. Press the Enter button (←) to enable or disable the selected item.
4. Navigate away from the Enable/Disable field to accept the change.
5. Press the Enter/Exit Screen button (LA) to exit the screen.

## Dispense Check Options, Screen #4

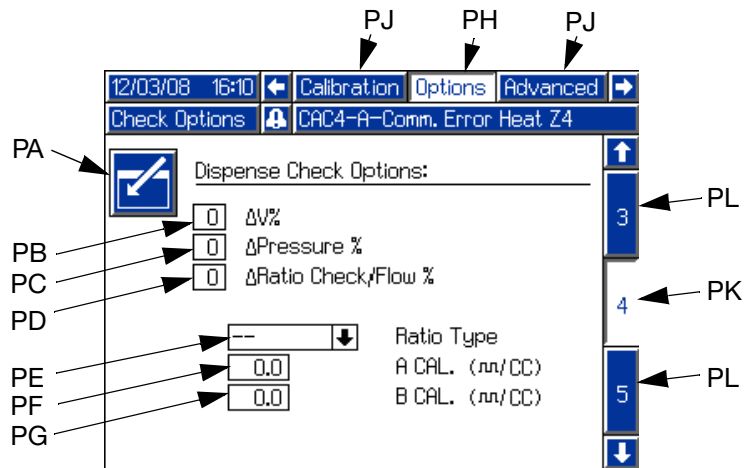
**Key:**

PA	Enter/Exit Screen	PG	B Side Flow Meter Calibration Factor
PB	Change in Velocity	PH	Active Screen Name
PC	Change in Pressure	PJ	Adjacent Screen Names
PD	Change in Ratio or Volume	PK	Active Screen Number
PE	Ratio Type (Volume or Weight)	PL	Adjacent Screen Numbers
PF	A Side Flow Meter Calibration Factor		

Fig. 18

**Change in Velocity, Change in Pressure, Change in Ratio or Volume**

**NOTE:** The machine must have pressure transducers installed for *Change in Pressure* to be available. The machine must have flow meters installed for *Change in Ratio or Volume* to be available. The *Change in Velocity* function is available on all machines. If a non-zero value is entered for an unavailable function, an error will be displayed if a dispense is beyond the tolerance percentage entered.

During machine calibration the machine measures and obtains base values for piston speed and fluid pressure. The machine also records when the pressure rises for each side, to get a base value for phasing.

**NOTE:** The pressure transducers are designed to work with the hoses available in the PR70 configurator. If they are used with other hoses, unexpected alarms may occur.

When any of these three dispense check features are enabled by entering a value other than zero, the machine will compare the value seen during each dispense to the values measured during calibration.

If the values are farther than the input percentage from the calibration values, an error is shown after the dispense. See **Error Codes** on page 72. This warning signals the user of a less than optimal dispense or possible machine malfunction.

The available input values for *Change in Velocity* and *Change in Pressure* are 0 (off), 20, 40, or 60 percent. The acceptable input value for *Change in Ratio or Volume* are 0 (off), or 1 through 10 percent. If an invalid number is entered, it will automatically be rounded to the nearest valid entry.

**Ratio Type**

Fluid ratio can be monitored as either weight-ratio (recommended) or volume-ratio. If the ratio type selected is "Volume", the calibration factor for each installed flow meter must be entered in the calibration factor fields (PF, PG). The calibration factor is found on the flow meter data sheet shipped with the machine.

After each shot, the ratio for that shot will be shown on the Home screen.



**Flow Meter/Ratio Monitoring Calibration, Screen #5**

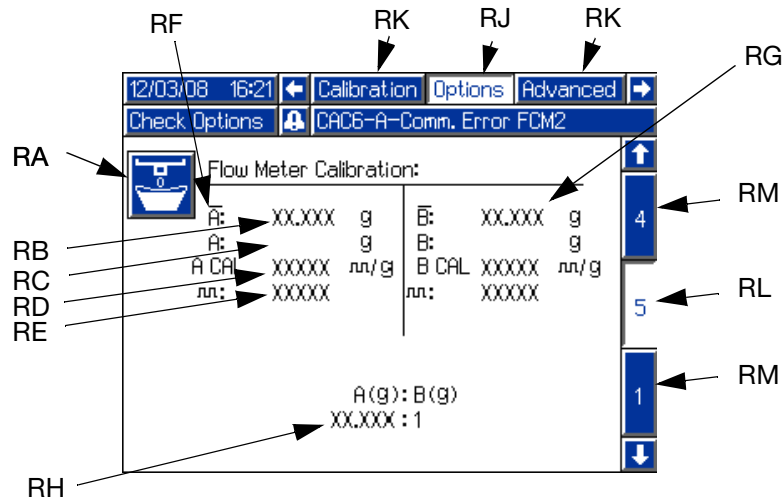

**Key:**

- |    |                            |    |                         |
|----|----------------------------|----|-------------------------|
| RA | Enter/Exit Screen          | RG | B Side Information      |
| RB | Average Calibration Weight | RH | A to B Weight Ratio     |
| RC | Material Weight Entry      | RJ | Active Screen Name      |
| RD | Cycles per Gram            | RK | Adjacent Screen Names   |
| RE | Total Cycles               | RL | Active Screen Number    |
| RF | A Side Information         | RM | Adjacent Screen Numbers |

**FIG. 19**

Proper calibration of the flow meters ensures that ratio and weight monitoring perform optimally. If the flow meter calibration factors are entered in Options Screen #4, the machine will accurately measure volume and the material weight dispensed counters will start tracking dispenses.

See **Flow Meter/Ratio Monitoring Calibration** on page 48.

## Advanced Setup Screen

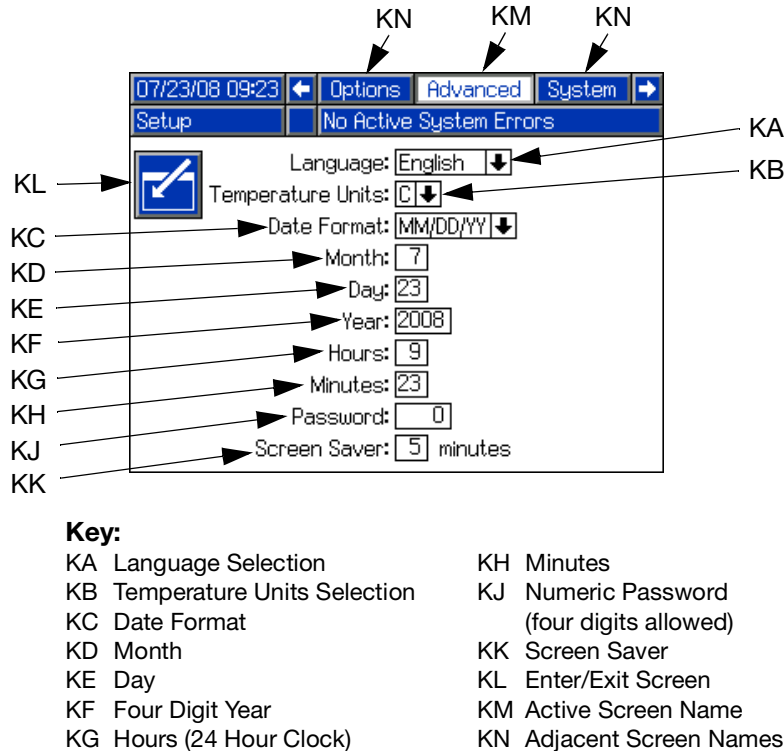

FIG. 20

### Password

If a password other than "0" is entered, the password is automatically enabled. The password protects entry into the setup screens. With the password enabled, the restricted user may still be able to change shot sizes, erase counters, or modify temperatures depending on the options enabled on the System Options Setup Screen. To prohibit the restricted user from changing these settings, enable the appropriate options; see **System Options, Screen #3** on page 31.

### Screen Saver

The screen saver turns off the screen backlighting after the given number of minutes. To disable the screen saver, press any button.

### Languages

The language selection feature will change the language of all text on the display module. Available languages are English, Spanish, French, German, Chinese, Japanese, Korean, Russian, and Italian.

### Date Formats

There are three available formats: MM/DD/YY, DD/MM/YY, and YY/MM/DD.

### Edit Settings

1. Press the Enter/Exit Screen button (KL) to enter the screen.
2. Use the arrow keys to navigate to the item to be changed.
3. **For numeric entries**, use the numeric keypad to enter the new value.  
**For non-numeric settings**, press the Enter button (↵) then use the Up Arrow button (↑) and the Down Arrow button (↓) to change the selection.
4. Press the Enter button (↵) to accept the new value or selection and exit editing mode.

## System Data Screen

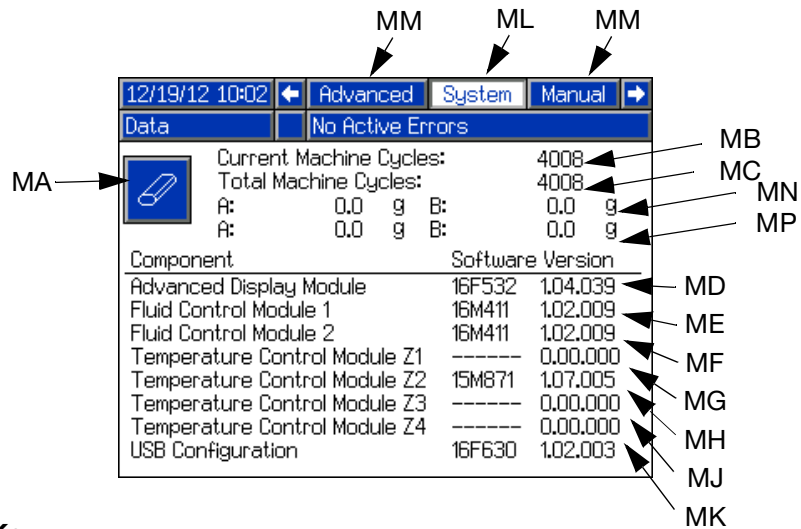

### Key:

- |  |  |
|--|--|
| MA Enter/Exit Screen                                     | MH Temperature Control Module - Zone #2 Software Version |
| MB Current Machine Cycles Counter                        | MJ Temperature Control Module - Zone #3 Software Version |
| MC Total Machine Cycles Counter                          | MK Temperature Control Module - Zone #4 Software Version |
| MD Advanced Display Module Software Version              | ML Active Screen Name                                    |
| ME Fluid Control Module #1 Software Version              | MM Adjacent Screen Names                                 |
| MF Fluid Control Module #2 Software Version              | MN Resettable material weight counter                    |
| MG Temperature Control Module - Zone #1 Software Version | MP Non-resettable material weight counter                |

FIG. 21

### Software Version

Software version will read "0.00.000" if component cannot be seen by the ADM. This is the result of the component not being installed or a communication error.

### Machine Cycles

A machine cycle is one full extension and retraction of the machine piston. The Current Machine Cycles Counter is resettable and the Total Machine Cycles Counter is the number of cycles since the ADM was installed. Reprogramming the ADM will not reset the Total Machine Cycles counter.

### Reset Current Machine Cycles Counter

1. Press the Enter/Exit Screen button (MA) to enter the screen. The Current Machine Cycles count will be highlighted.
2. Press the Enter button () to reset the Current Machine Cycles counter.
3. Press the Enter/Exit Screen button (MA) to exit the screen.

## Manual Screen

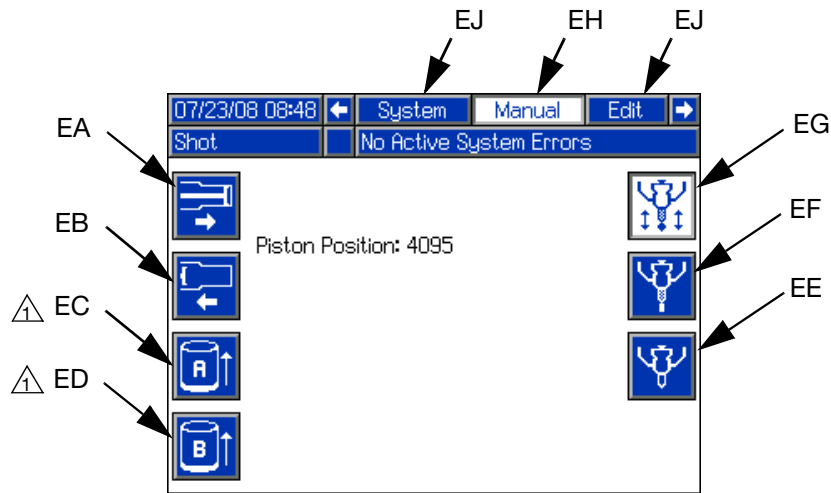

 Valve will open for approximately two seconds.

**Key:**

- EA Extend Piston Command
- EB Retract Piston Command
- EC Tank A Refill Valve Command Open
- ED Tank B Refill Valve Command Open
- EE Dispense Valve Command Close
- EF Dispense Valve Command Open
- EG Revert to Automatic Dispense Valve Operation
- EH Active Screen Name
- EJ Adjacent Screen Names

**FIG. 22**

The Manual screen overrides control of some machine actions. This can be useful in troubleshooting. To perform any of the available machine actions shown on the Manual screen, press the appropriate button.

## Edit Settings

- Edit Display Settings:  
See **Advanced Setup Screen**, page 34.
- Edit Shots and Sequences:  
See **Edit Screens**, page 23.
- Edit Recirculation and Purge Timers:  
See **Fluid Options, Screen #1**, page 27.
- Edit Level Sensor Settings:  
See **Fluid Options, Screen #1**, page 27.
- Edit Temperature Control Settings:  
See **Heat Options, Screen #2**, page 29.
- Edit System Options:  
See **System Options, Screen #3**, page 31.

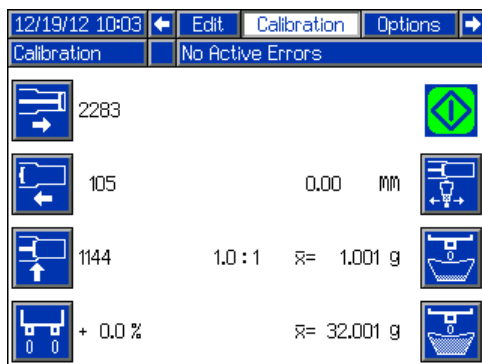

## Piston Position Calibration



**FIG. 23: Calibration Screen**

The position sensor assigns a numeric value to the location of the piston. Higher numbers indicate the piston is extended and lower numbers indicate the piston is retracted.

The Piston Position Calibration procedure teaches the machine the location of the most extended piston position

() , the most retracted piston position () , and the position where the piston engages the pump cylinder () .

Perform the Piston Position Calibration procedure when first setting up the machine. Also perform this procedure if the linear position sensor, piston, or any electronic component has been replaced.

## Prepare Machine for Calibration



1. Ensure that both piston shafts are screwed all the way into the drive block.
2. Ensure there is a sufficient amount of material in the tanks.
3. Navigate to the Calibration screen. See **Screen Navigation Diagram**, page 17.
4. Place a waste container under the dispense valve to capture any dispensed material.
5. Ensure system air pressure relief switch (106) is in the up position and the system air pressure regulator (105) shows air pressure in the system.



## Extended Piston Position

6. With air pressure applied to the machine, press the Extend Piston button () .



7. Press the Start/Stop Shot button () . The piston will fully extend and a number 3600-3900 should be displayed. If a number significantly different from 3600-3900 is displayed, ensure the air cylinder air line connections are not switched and that the linear position sensor is installed correctly.

 If the piston does not extend after pressing the Start/Stop Shot button () the air pressure may need to be increased. Use system air pressure regulator (105) to increase the air pressure in increments of 10 psi until the piston activates. Material will be dispensed when adequate pressure is achieved.



8. Press the Enter button () to accept the new value or press the Abort/Cancel button () to keep the previous value.

### Retracted Piston Position



- With air pressure applied to the machine, press the Retract Piston button ().



- Press the Start/Stop Shot button (). The piston will fully retract and a number from 1250 to 1600 will be displayed next to the Retract Piston button. If a number outside of this range is displayed, ensure the air cylinder air line connections are not switched and that the linear position sensor is properly installed.

- Press the Enter button () to accept the value or press the Abort/Cancel button () to keep the previous value.

### Engaged Piston Position





- Use air pressure regulator to decrease air pressure in the system to zero.
- Place a clean waste container under the dispense valve.
- Press the Engage Piston button ().
- With no air pressure in the system, press the Start/Stop Shot button ().
- Move the piston drive block until it just begins to engage the cylinder using one of the following methods. No material should be dispensed.

#### Use Air Pressure to Move Piston Drive Block



- Use the air pressure regulator to slowly increase air pressure in the system until the piston drive block begins to extend and encounters the cylinder entrance. A number from 2000 to 2400 will be displayed.

 If a number outside of this range is displayed, ensure the air cylinder air line connections are not switched and that the linear position sensor is properly installed.

### Manually Move the Piston Drive Block

						
In the steps below, ensure pressure is off or piston may activate and pinch fingers against machine block.						

- Press down the system air pressure relief switch (106).
  - Remove machine cover.
  - With no air pressure in the system manually push the piston drive block until the piston engages the cylinder and resists movement. A number from 2000 to 2400 will be displayed.
-  If a number outside of this range is displayed, ensure the air cylinder air line connections are not switched and that the linear position sensor is properly installed.
- Lift the system air pressure relief switch (106) to enable system pressure.
- Ensure there is no material in the waste container under dispense valve. The piston block moved too far and caused material to be dispensed if there is material in the waste container. Go back to step 12 if the piston moved too far.

- Press the Enter button () to accept the value or press the Abort/Cancel button () to keep the previous value.

### Prepare Machine for Operation

- Adjust the system air pressure regulator (105) to increase air pressure to standard operating pressure for your application.
- Navigate to the Home screen. See **Screen Navigation Diagram**, page 17.

## Prime the Dispense Head

### CAUTION

If the dispense head is not primed, chemical cross-over may occur resulting in cured material in the dispense head, hoses, and/or pumps.

 See FIG. 24.

1. Remove static mixer from the dispense head (102) if installed.
2. Turn snuff-back adjustment knob (103) fully clockwise. This will prevent the dispense valve from closing between priming shots.
3. Use a 4 mm hex key to loosen the screws (102a) holding the dispense head in place.
4. Rotate dispense head (102) so the tip is above the fluid input hoses.

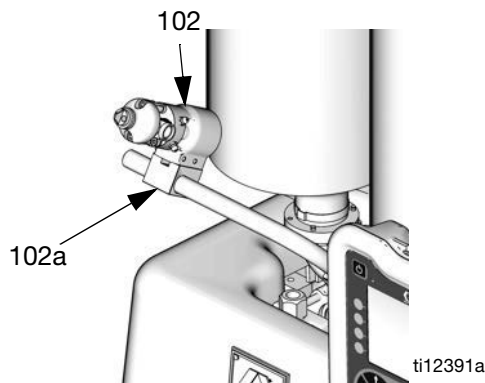



**FIG. 24: Prime Dispense Head**

5. Use a 4 mm hex key to tighten screws (102a) holding dispense head in place.
6. Route the fluid hoses connected to the dispense head so they are always below the dispense head. This ensures any air in the hoses will travel to the dispense head.
7. Navigate to the Home Screen. See **Screen Navigation Diagram**, page 17.

8. Select a large size shot.



9. Hold a waste container at the end of the dispense head (102) and press the Start/Stop Shot button () or the footswitch.
10. Repeat the previous step until no air comes out of the dispense valve.
11. If phasing adjustments and ratio checking are not required, use the following procedure to attach the static mixer.
  - a. Attach the static mixer with the dispense head pointed up.
  - b. Hold waste container at end of dispense head (102) and press the Start/Stop Shot button () or the footswitch.
  - c. Repeat the previous steps until static mixer has been purged of air.
12. Use a 4 mm hex key to loosen screws (102a) holding dispense head in place.
13. Rotate dispense head back to normal dispensing position.
14. Use a 4 mm hex key to tighten the screws (102a) holding the dispense head in place.
15. Adjust snuff back to proper setting for operation. See **Adjust Dispense Valve Snuff Back** on page 42.

## Phasing Adjustment

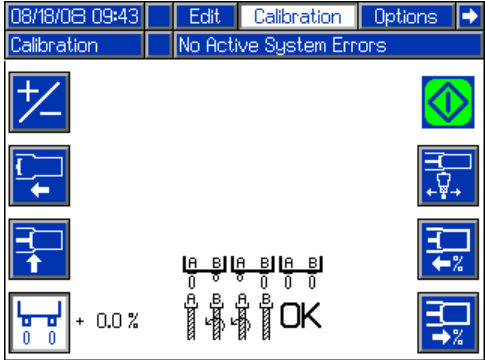

FIG. 25: Phasing

When the machine executes a shot, materials from Tank A and Tank B enter the static mixer where they are mixed and then dispensed. In order for the materials to mix at the desired ratio, both materials must enter the static mixer at the same time. The timing of the materials entering the static mixer is dependent on the adjustment of the phase adjustment screw for each piston.

### Prepare Machine

1. Place a waste container under the dispense valve to catch dispensed material.
2. Remove static mixer from dispense valve.
3. Install ratio check nozzle onto dispense valve.

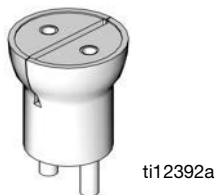





FIG. 26: Ratio Check Nozzle

4. If necessary, place a stand under ratio check nozzle to support waste container close to nozzle.
5. Navigate to the Calibration screen. See **Screen Navigation Diagram**, page 17.

### Adjust Dispense Quantity

6. Press the Enter/Exit Phasing button () to enter phasing mode.



7. Press the Start/Stop Shot button () or the footswitch to dispense a very small amount of material.
8. Adjust the displayed percentage if more than a couple drops of either material was dispensed or if no material was dispensed from both sides.
  - If too much material was dispensed, decrease the phasing percentage. If necessary, use the +/- button () to switch the percentage from positive to negative.
  - If no material was dispensed, increase the displayed percentage. If necessary, use the +/- button () to switch the percentage from negative to positive.



## Adjust Phasing

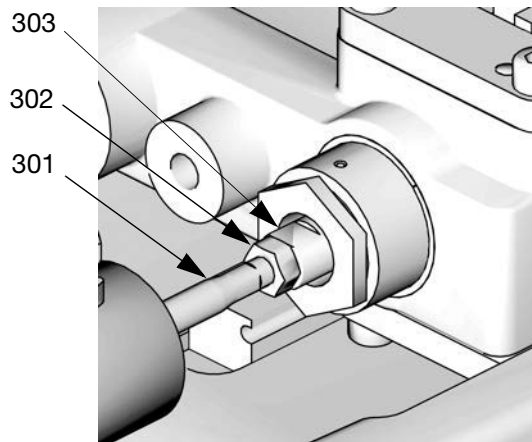



### Key:

- 301 Piston Shaft  
302 Locking Nut  
303 Phase Adjustment Screw

ti12389a



9. Watch the dispense valve carefully to observe which material is dispensed first. Press the Start/Stop Shot button () or the footswitch to dispense material.
10. If the materials do not exit the dispense valve at the same time adjust the piston Phase Adjustment Screw (303) as follows.
  - If the A side material exits the dispense nozzle before the B side material ():
    - a. Use two 13 mm wrenches to break loose the locking nut (302) from the phase adjustment screw (303) on the B material side.
    - b. Hold the phase adjustment screw (303) stationary with a 13 mm wrench.
    - c. Use a 7 mm wrench to turn the piston shaft (301) counterclockwise 1/4 turn or less to move the B piston forward.

- If the B side material exits the dispense nozzle before the A side material ():
  - a. Use two 13 mm wrenches to break loose the locking nut (302) from the phase adjustment screw (303) on the A material side.
  - b. Hold the phase adjustment screw (303) stationary with a 13 mm wrench.
  - c. Use a 7 mm wrench to turn the piston shaft (301) counterclockwise 1/4 turn or less to move the A piston forward.

 It is highly recommended that all of the phasing adjustment be done to one side or the other; not both.

 Ensure the piston shaft and phase adjustment screw do not rotate while tightening the locking nut (302) in the following step.

11. Hold piston shaft (301) and phase adjustment screw (303) in place with a 7 mm and 13 mm wrench and tighten locking nut (302) against phase adjustment screw with a 13 mm wrench.



12. Watch the dispense valve carefully to observe which material is dispensed first. Press the Start/Stop Shot button () or the foot switch to dispense material. If one material exits the dispense nozzle before the other, go back to step 10.

### Exit Calibration Mode

13. Press the Enter/Exit Phasing button ()
14. Navigate to the Home screen. See **Screen Navigation Diagram**, page 17.

## Adjust Dispense Valve Snuff Back



At the end of a shot, a small amount of material is drawn back into the static mixer to prevent extra material from being dispensed. If too much snuff back occurs air will enter the static mixer and can travel up into the dispense valve. If too little snuff back occurs the materials may drip out of the static mixer and affect dispense quantity.

It is most efficient to adjust the snuff back while material is dispensing but it can also be adjusted when there is no air pressure in the system.

1. Navigate to the Home screen. See **Screen Navigation Diagram**, page 17.
2. Select a small size shot.
3. If a static mixer is not in place, install one then prime the machine. See **Prime the Dispense Head**, page 39.
4. Place a waste container under static mixer.
5. Press the Start/Stop Shot button ()
6. Inspect the tip of the static mixer for dripping material or for air bubble traveling up the mixer.
7. Perform another shot and while dispensing adjust the snuff-back adjustment knob (103) as follows.
  - If an air bubble is moving up the mixer, turn knob clockwise to decrease snuff back.
  - If material is hanging from tip of mixer, turn knob counterclockwise to increase snuff back.
8. Repeat step 7 until snuff back is adjusted as desired.

## Adjust Open Dispense Valve (ODV) Timing

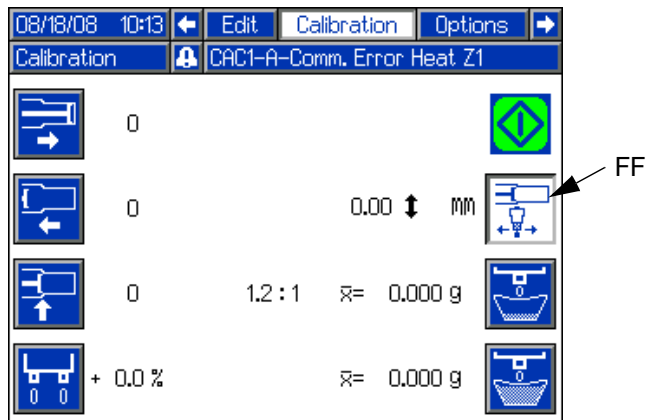

### Key:

FF Adjust Open Dispense Valve Timing

FIG. 27

When a shot is performed, the dispense valve needs to open at a precise time for material to be dispensed properly. If the dispense valve opens too early, material may drain from the static mixer before the shot starts. If the dispense valve opens too late, pressure may build in the machine before the dispense valve opens causing material to forcefully spray out of the mixer.

The Open Dispense Valve Timing should also be adjusted for material viscosity. Thicker materials should have the dispense valve open earlier and thinner materials should have the dispense valve open later.

A positive value for Open Dispense Valve Timing indicates the dispense valve will open after the piston is engaged in the cylinder. A negative value indicates the dispense valve will open before the piston is engaged in the cylinder.

If a high positive number is entered for ODV timing, such as 6.0 mm, the dispense valve may not open resulting in the fluid stalling against the dispense valve. The fluid in the hose lines will remain under pressure until the piston is manually retracted using the Manual screen, see **Manual Screen** on page 36.



1. Navigate to the Calibration screen. See **Screen Navigation Diagram**, page 17.
2. Press the Adjust Open Dispense Valve Timing button (FF).
3. Use the numeric keypad to enter a value for the ODV Timing. Use the +/- key to switch from positive to negative and negative to positive.
4. Press the Enter button (←) to accept the new value or press the Abort/Cancel button (⊗) to keep the previous value.

## Calibrate Dispense Weight Ratio (PR70v only)

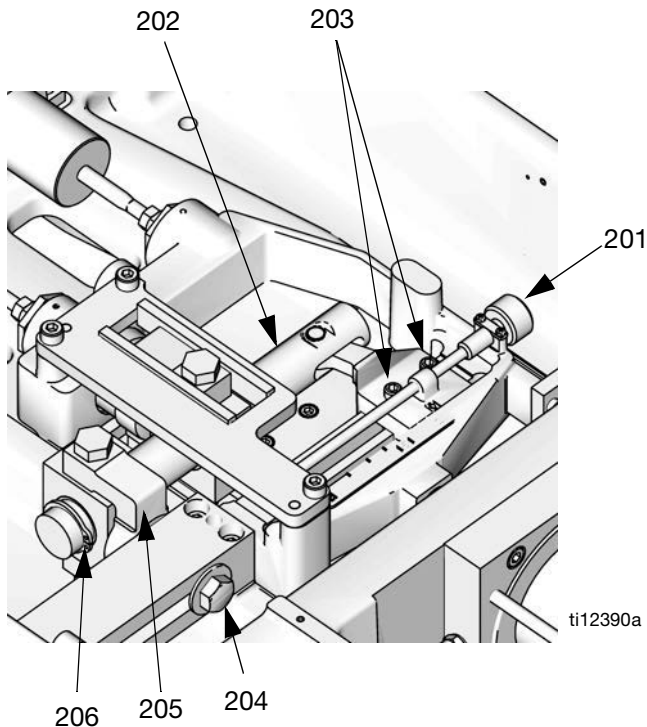

### Key:

- 201 Ratio Adjustment Knob
- 202 Ratio Beam
- 203 Socket Head Cap Screws
- 204 Hex Head Cap Screw
- 205 Ratio Beam Guide
- 206 Ratio Beam Snap Ring

FIG. 28: Ratio Adjustment

The PR70v base unit can dispense volume ratios in the range of 1:1 to 24:1. The range of A to B cylinder size ratios is 1:1 to 12:1. The mechanical ratio arm multiplies the constant cylinder size ratio by a range of 1:1 to 2:1 depending on the ratio arm adjustment.

A Tube Piston Size (mm <sup>2</sup> )	B Tube Piston Size (mm <sup>2</sup> )	Minimum Ratio by Volume (1:1 Position)	Maximum Ratio by Volume (2:1 Position)
960	960	1:1	2:1
960	480	2:1	4:1
960	320	3:1	6:1
960	240	4:1	8:1
960	80	12:1	24:1

### Prepare Machine for Dispense Weight Ratio Calibration

1. Verify the piston position is calibrated. See **Piston Position Calibration**, page 37.
2. Verify the dispense head is properly primed. See **Prime the Dispense Head**, page 39.
3. Verify the machine is properly phased. See **Phasing Adjustment**, page 40.
4. Find the desired ratio arm setting from 1:1 to 2:1.





For this step, the desired **volume** ratio must be known. Using the desired **weight** ratio will cause calculation errors.

- a. Divide the side A piston size by the side B piston size to get the piston **volume** ratio. For example, if the A piston size is 960 mm<sup>2</sup> and the B piston size is 480 mm<sup>2</sup> then  $960 / 480 = 2$ .
- b. Divide the desired dispensing volume ratio by the piston volume ratio to get the desired ratio arm setting. For example if the desired dispensing volume ratio is 2.38:1 and the piston volume ratio is 2:1 then  $2.38 / 2 = 1.19$ .

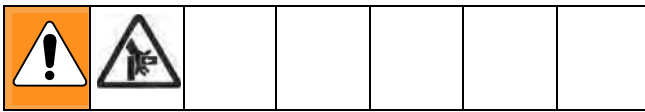
5. Change the mechanical ratio adjustment to the desired setting (**1.19 in the example**) as follows.
  - a. Ensure the machine pistons are in the retracted position.
  - b. Ensure the purge timer is off and the machine is not in recirculation mode.
  - c. Use system air pressure regulator (105) to decrease air pressure in the system to zero.
  - d. Navigate to the Manual screen. See **Screen Navigation Diagram**, page 17.



- e. Press the Extend Piston Command button ()
- f. Use the system air pressure regulator (105) to slowly increase the air pressure until the ratio beam (202) is parallel to the pump body.
- g. Use system air pressure regulator (105) to return the air pressure in the system to zero.
- h. Press down the system air pressure relief switch (106).
- i. Close the shop ball valve supplying air to the system.
- j. Press the Machine Disable Mode key ()

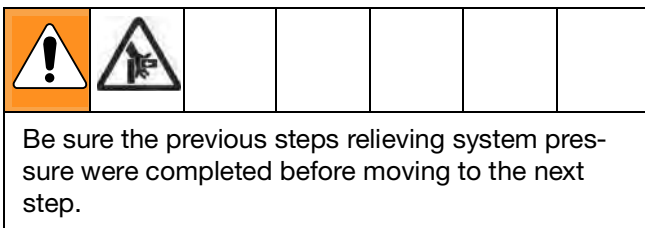

- k. Loosen the socket head cap screw (203) on the adjustment clevis. See FIG. 28.

- l. Loosen the hex head cap screws (204) on the ratio adjustment pivot.
- m. Turn the ratio adjustment knob (201) clockwise to increase the ratio and counterclockwise to decrease the ratio until the mechanical ratio arm is set to the desired setting (**1.19 in the example**).
- n. Tighten the hex head cap screws (204) on the ratio adjustment pivot.
- o. Slide the ratio beam guide (205) so there is approximately a 0.5 mm gap between the ratio beam guide (205) and the snap ring (206) shown in FIG. 29.

#### CAUTION

Damage to the ratio mechanism will result if the proper clearance is not present.

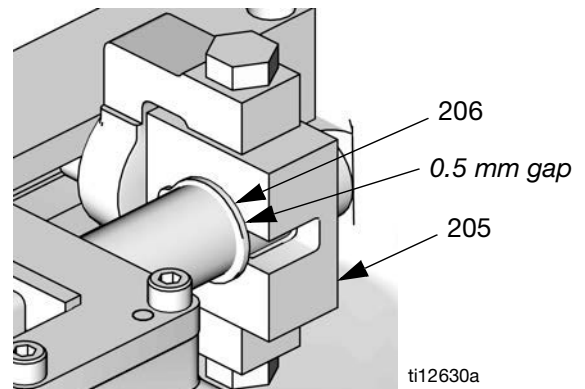

**FIG. 29: Ratio Beam Snap Ring**

- p. Tighten the socket head cap screw (203) on the adjustment clevis.
- q. Open the shop ball valve supplying air to the system.
- r. Lift up the system air pressure relief switch (106).
- s. Use system air pressure regulator (105) to return to the standard operating air pressure for your application.



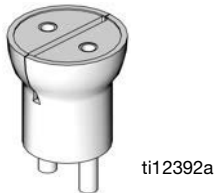

6. Navigate to the Home screen. See **Screen Navigation Diagram**, page 17.
7. Phase the machine. See **Phasing Adjustment**, page 40.

### Perform Weight Ratio Check Shot

8. Install ratio check nozzle onto dispense valve.



**FIG. 30: Ratio Check Nozzle**

9. Place a waste container under the dispense valve to capture any dispensed material.
10. Press the Select Operating Mode button (  ) repeatedly until Shot Mode is selected.
11. Press the Enter button (  ) to accept the new operating mode.
12. Select a shot.
13. Press the Start/Stop Shot button (  ) or the foot-switch to dispense material.
14. Discard the shot.
15. Label one scale as “A” and a second scale as “B”.
16. Label one new container as “A” and a second new container as “B”.
17. Place container “A” on scale “A” and tare the scale. Place container “B” on scale “B” and tare the scale.
18. Place container “A” under the A material output of the ratio check nozzle. Place container “B” under the B material output of the ratio check nozzle.
19. Press the Start/Stop Shot button (  ) or the foot-switch to dispense material.
20. Place container “A” on scale “A” and note the weight. Place container “B” on scale “B” and note the weight.

21. Divide the weight of container “A” by the weight of container “B” to get the weight ratio of the dispensed materials.
22. Repeat steps 16 through 21 at least two more times for an overall total of at least three ratio check shots, or repeat as needed.
23. If the average A to B ratio of the dispensed materials is too high or too low, adjust the mechanical ratio arm as required by repeating steps 5 through 22 until the dispensing ratio is correct.
  - If the A to B ratio is too high, turn the ratio adjustment knob (201) counterclockwise to adjust the mechanical ratio arm towards the 1:1 position.
  - If the A to B ratio is too low, turn the ratio adjustment knob (201) clockwise to adjust the mechanical ratio arm towards the 2:1 position.

### Secure Dispensing Ratio

24. Once the ratio check shots confirm the A to B dispensing ratio is correct, tighten all screws holding the ratio beam (202) in place.
  - a. Tighten the socket head cap screws (203) holding the ratio beam (202) in place to 140 in-lb (15.8 N•m).
  - b. Tighten the hex head cap screw (204) holding the ratio beam guide (205) in place to 350 in-lb (39.5 N•m).

### Prepare Machine for Operation

25. Remove ratio check nozzle and install static mixer or night cap as necessary.



## Shot Calibration



To dispense accurate quantities of material, a few small and large calibration shots must be performed. Once the weights are entered, the machine will calculate an average weight for the small and large calibration shots.

### Prepare for Calibration





1. Verify the piston position is calibrated. See **Piston Position Calibration**, page 37.
2. Verify the dispense head is properly primed. See **Prime the Dispense Head**, page 39.
3. Verify the machine is properly phased. See **Phasing Adjustment**, page 40.
4. Verify the dispensing ratio is adjusted as needed. See **Calibrate Dispense Weight Ratio (PR70v only)**, page 44.
5. Retrieve multiple waste containers.
6. Locate a weigh scale near the machine.
7. Install a static mixer.
8. Prime the dispense head. See **Prime the Dispense Head**, page 39.
9. Clean the surface below static mixer of any debris or materials that might cling to the waste container and affect weight measurements.
10. Navigate to the Calibration screen. See **Screen Navigation Diagram**, page 17.

### Perform Small Calibration Shots

11. Press Small Calibration Shot button () to enter calibration mode.
12. Use the numeric keypad to enter the ratio arm setting. Valid entries are 1.0 to 2.0 in 0.1 increments.
13. Press the Enter button () to accept the value.
14. Weigh one clean waste container and tare the scale.
15. Place container under static mixer.
16. Press the Start/Stop Shot button () or the footswitch to dispense material.

17. Weigh container.
18. Enter weight in grams using numeric keypad.
19. Press the Enter button () to accept the number or press the “0” button on the numeric keypad repeatedly to clear out the entry then re-enter.
20. Repeat steps 14 through 19 as needed. Graco recommends repeating steps 14 through 19 at least four more times. The machine will automatically calculate the average weight of the calibration shots.
21. Press Small Calibration Shot button () to exit calibration mode.

### Perform Large Calibration Shots

22. Press Large Calibration Shot button () to enter calibration mode.
23. Weigh one clean waste container and tare the scale.
24. Place container under static mixer.
25. Press the Start/Stop Shot button () or the footswitch to dispense material.
26. Weigh container.
27. Enter weight in grams using numeric keypad.
28. Press the Enter button () to accept the number or press the “0” button on the numeric keypad repeatedly to clear out the entry then re-enter.
29. Repeat steps 23 through 27 as needed. Graco recommends repeating steps 23 through 27 at least four more times. The machine will automatically calculate the average weight of the calibration shots.
30. Press the Large Calibration Shot button () to exit calibration mode.

# Flow Meter/Ratio Monitoring Calibration

## Prepare for Calibration

1. Verify the piston position is calibrated. See **Piston Position Calibration**, page 37.
2. Verify the dispense head is properly primed. See **Prime the Dispense Head**, page 39.
3. Verify the machine is properly phased. See **Phasing Adjustment**, page 40.
4. Verify the dispensing ratio is adjusted as needed. See **Calibrate Dispense Weight Ratio (PR70v only)**, page 44.
5. Retrieve multiple waste containers.
6. Locate a weigh scale near the machine.
7. Clean the surface below the static mixer of any debris or materials that might cling to the waste container and affect weight measurements.
8. Install the ratio check nozzle onto the dispense valve.

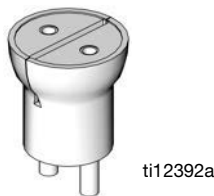

FIG. 31: Ratio Check Nozzle

9. Prime the dispense head. See **Prime the Dispense Head**, page 39.
10. Navigate to the Options 4 screen. See the **Screen Navigation Diagram**, page 17.

11. Verify that a non-zero percentage is entered for the Delta Ratio field and a Ratio Mode (weight is recommended) is selected. See FIG. 32.

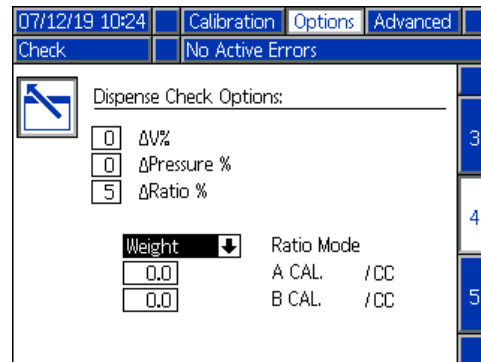

FIG. 32: Dispense Check Options

## Perform Flow Meter/Ratio Assurance Calibration Dispense

12. Navigate to the Options 5 screen.

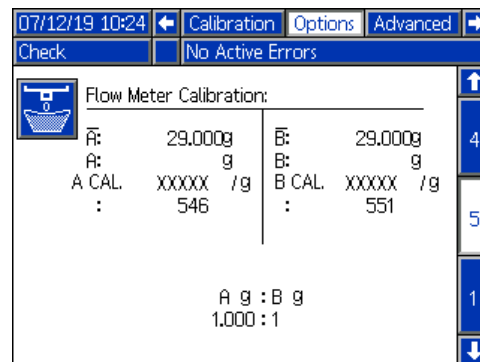



FIG. 33: Flow Meter Calibration

13. Press the Calibration button (  ) to start the calibration process.

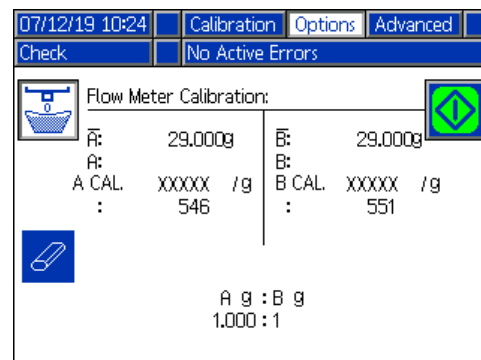

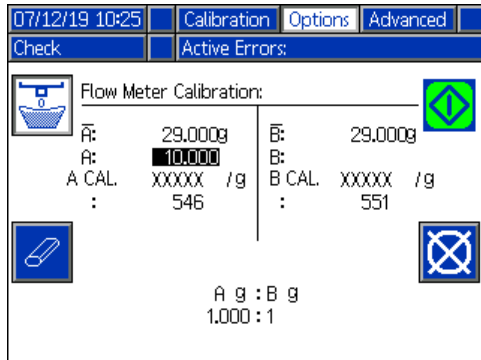



FIG. 34: Starting the Calibration Process



14. Place two containers under each end of the ratio check nozzle to catch the material for a dispense. Verify the empty containers are tared with a scale.
15. Press the Start/Stop Shot button () or activate the machine foot switch to start a dispense.
16. At the end of the dispense, weigh the A side material, then enter the net weight (in grams) in the field provided on the left side of the screen. See FIG. 35.



**FIG. 35: Enter Net Weight**

17. Weigh the B side material and enter its value in the field on the right side of the screen.
18. If you are calibrating a variable ratio machine and the ratio provided from the dispense is not the desired amount (displayed on the bottom of the screen, as shown in FIG. 35), change the mechanical ratio adjustment accordingly.
19. If necessary, repeat steps 14-18 accordingly until the desired results are achieved. The machine will average the entries if the process is repeated.
20. If completed, press the Calibration button () to exit the calibration process.

21. Once completed after a dispense, the Home screen displays the actual ratio of the dispense in the field indicated. If the actual ratio is outside the percentage tolerance entered in the Delta Ratio field on the Options 4 screen, a high or low ratio error will be generated at the end of the dispense.

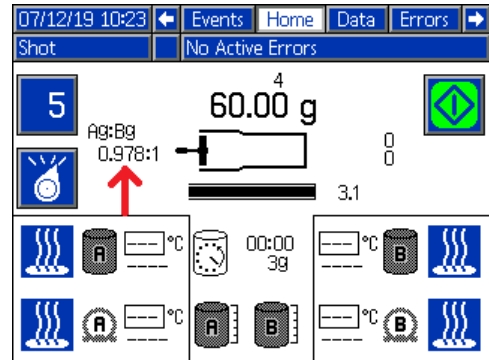
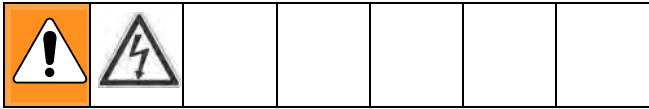

**FIG. 36: Home Screen**

## Dispense Verification

See **Dispense Check Options, Screen #4**, page 32.

# External Control Interface Setup



## Connector #2

**NOTE:** Connector #2 is for use with systems with an Advanced Display Module only.

**NOTE:** View shown is looking at pins on end of cable.

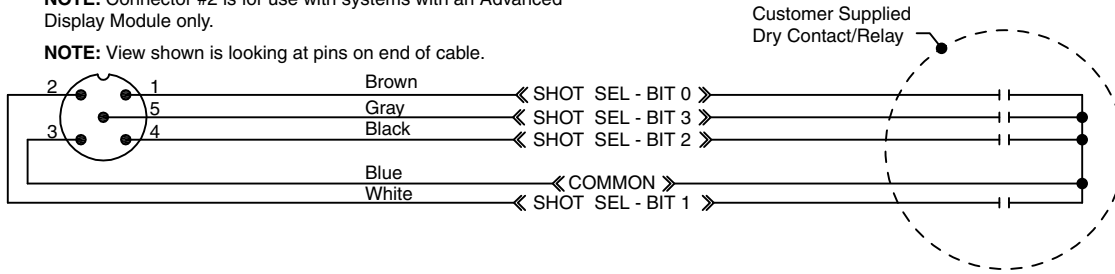

## Connector #1

**NOTE:** Connector #1 is for use with all systems.

**NOTE:** View shown is looking at pins on end of cable.

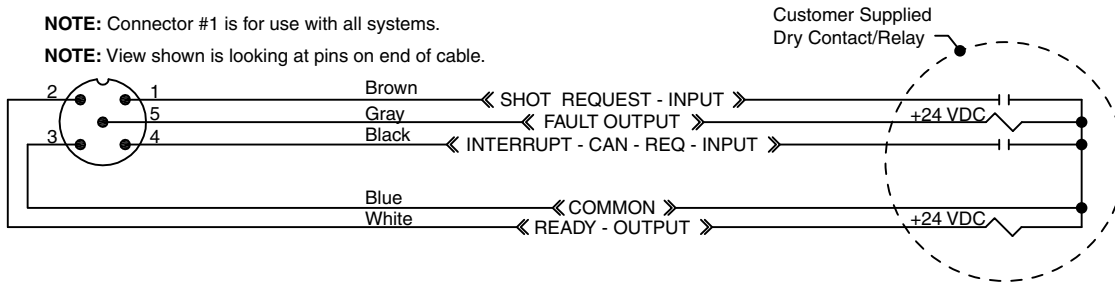

**FIG. 37: External Control Interface Electrical Diagram**

The external control interface allows an external machine to control the PR70. The external machine can use Connector #1 to send dispense request and abort commands. Also, Connector #1 indicates to the external machine whether the PR70 is ready to dispense. Connector #2 is used to select a shot number. See FIG. 38 for connector location on the PR70.

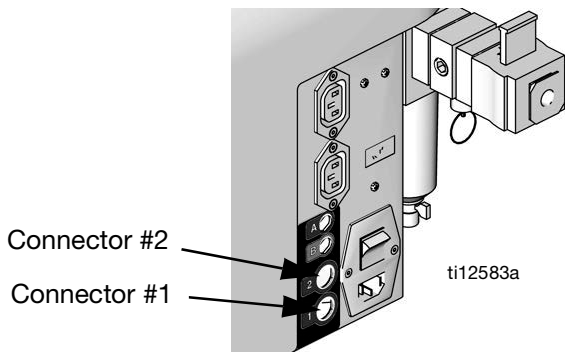

**FIG. 38: External Control Connectors**

## Ready-Output Status Line

The Ready-Output status line (“READY-OUTPUT” in FIG. 37, Connector #1, Pin #2) is a signal provided to the external control. The line indicates whether a shot or dispense request will be accepted by the machine. The output of the Ready-Output status line is a “high” +24 VDC signal when the system is ready to dispense. The output is a “low” +15 VDC signal when the system is not ready to dispense. See FIG. 39 on page 53 for a sample timing diagram.

The following conditions will make the machine not ready to accept a dispense request.

- Dispensing in progress.
- User is programming the display module.
- Active error code that has not been acknowledged.
- Auto-Sequencing in progress.

## Fault-Output Status Line

The Fault-Output status line (“FAULT-OUTPUT” in FIG. 37, Connector #1, Pin #5) indicates whether there is an active error. Active errors typically stop system operation. After using the display module to acknowledge the error, normal operation will be allowed.

The output of the Fault-Output status line is a “high” +24 VDC signal when an active error exists. The output is a “low” +15 VDC signal when there is not an active error. See FIG. 39 on page 53 for a sample timing diagram.

## Dispense Request Line

The Dispense Request line (“Shot Request” in FIG. 37, Connector #1, Pin #1) is used to request a shot. The Dispense Request line operates the same as the machine foot switch and the Start/Stop Shot

button (). When not in Operator mode and with a “high” Ready-Output signal, generate a short active Dispense Request signal to request a shot to begin. During dispensing, generate a short active signal in the Dispense Request line to abort the shot.

To generate an active Dispense Request signal, the external control will need to ground the Dispense Request line to the Return line (Connector #1, Pin #3) for 0.175 seconds to create a “low” signal. Remove the line from the Return line to end the active signal. See FIG. 39 on page 53 for a sample timing diagram.

If the active signal is generated when the system is in programming mode or generating an error code, the shot request will be ignored.

If the active signal is sent during execution of a pause when in Auto-Sequencing, the machine will abort the pause timer and begin dispensing the next shot in the sequence.

If the active signal is sent during execution of a shot in a sequence, the machine will abort the shot and will increment to the next shot in the sequence after the pistons fully retract. If the sequence is in auto-sequencing, the sequence pause timer will then begin.

If Operator (Manual) mode is selected, the machine will dispense while the active signal is sent. When the active signal stops, the machine will stop dispensing. If the piston Auto-Retract option is enabled on the System Options screen, the piston will retract when the machine stops dispensing. See FIG. 17 on page 31. If the Piston Auto-Retract is disabled, the machine will stop dispensing and stall the pumps against the dispense valve. If the pump is more than 80% into the metering tube, it will automatically retract regardless of whether Piston Aut-Retract is enabled.

## Interrupt - Cancel Line

The Interrupt - Cancel line (“INTERRUPT - CAN - REQ - INPUT” in FIG. 37, Connector #1, Pin #4) is used to abort a shot or reset a sequence. If an active signal is sent during a sequence, any active dispensing will be aborted and the sequence position will be reset to the first non-zero shot in the sequence.

To generate an active Interrupt - Cancel signal, the external control will need to ground the Interrupt - Cancel line to the Return line (Connector #1, Pin #3) for 0.175 seconds to create a “low” signal. Remove the line from the Return line to end the active signal.

*For system software versions 1.06.007 or later, if the Interrupt - Cancel line is held “low” the machine will be disabled and will not dispense.*

### Shot Number Selection Lines

The external control interface has four lines used to select a shot number (“SHOT - SEL - BIT” lines in FIG. 37, Connector #2, Pins #1, 2, 4, 5). The default for each line is a “high” +24 VDC output. To select a shot, the external control will need to ground a certain combination of lines to the Return line (Connector #2, Pin #3) for at least 0.100 seconds to create a “low” signal for each line. Each combination refers to one shot number from Shot #1 to Shot #15. If all lines are “high” the shot selected on the display module is used. See the following table. See FIG. 39 on page 53 for a sample timing diagram.

*For system software versions 1.06.007 or later, the Shot Number Selection lines cannot be used to select invalid or undefined shot numbers. Attempting to select an invalid or undefined shot number will be rejected.*

Shot Number Selected	SHOT - SEL - BIT0 (Conn. #2, Pin #1)	SHOT - SEL - BIT1 (Conn. #2, Pin #2)	SHOT - SEL - BIT2 (Conn. #2, Pin #4)	SHOT - SEL - BIT3 (Conn. #2, Pin #5)
None / Display Module selection.	High	High	High	High
1	Low	High	High	High
2	High	Low	High	High
3	Low	Low	High	High
4	High	High	Low	High
5	Low	High	Low	High
6	High	Low	Low	High
7	Low	Low	Low	High
8	High	High	High	Low
9	Low	High	High	Low
10	High	Low	High	Low
11	Low	Low	High	Low
12	High	High	Low	Low
13	Low	High	Low	Low
14	High	Low	Low	Low
15	Low	Low	Low	Low

### External Control Interface Timing

The following timing diagram illustrates changing the shot number to Shot #13 then dispensing that shot.

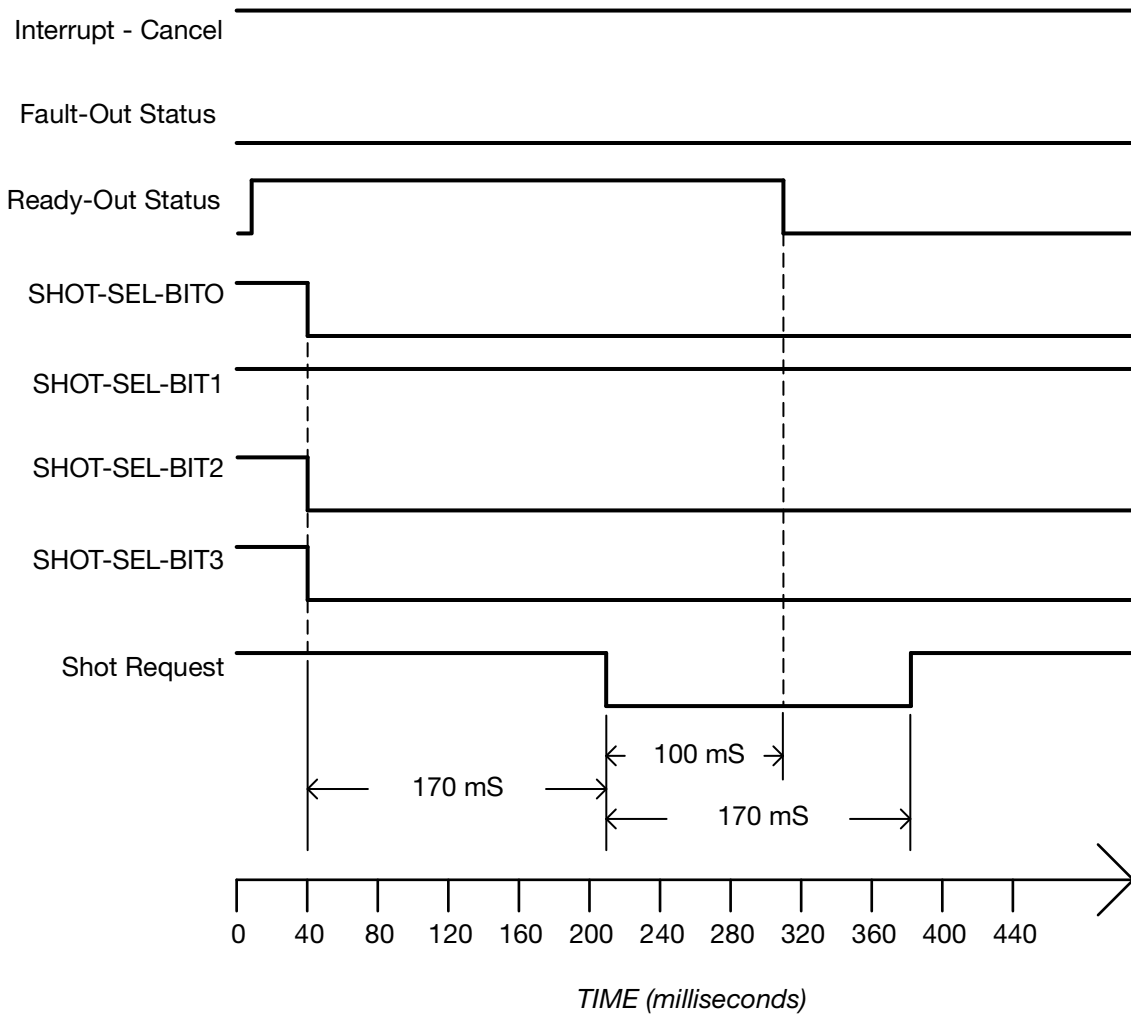

**FIG. 39: External Control Timing Diagram**

# Operation

## Operation Screens

### Home screen



Read all manufacturer's warning and material MSDS to know the specific hazards of the materials used.

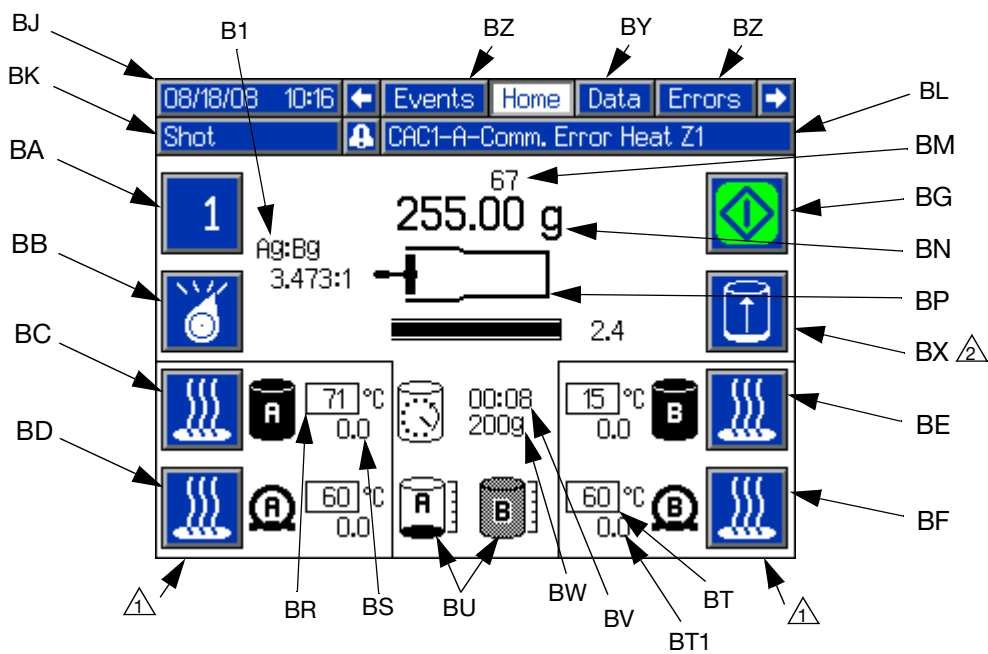

⚠ Temperature status will only be displayed if heaters are installed and enabled.

⚠ Only visible if Auto-Refill is installed and the High Level Sensors option on the Fluid Options Screen is set to an option other than Disabled. See **Fluid Options, Screen #1**, page 27.







**Key:**

- |                                 |  |
|---------------------------------|--|
| BA Active Shot/Sequence         | BR Tank Fluid Temperature Setpoint           |
| BB Select Operating Mode        | BS Tank Fluid Temperature                    |
| BC Side A Blanket Heater On/Off | BT Hose Heater Temperature Setpoint          |
| BD Side A Hose Heater On/Off    | BT1 Hose Heater Temperature                  |
| BE Side B Blanket Heater On/Off | BU Tank Fluid Level Status                   |
| BF Side B Hose Heater On/Off    | BV Purge Timer Delay Status                  |
| BG Start/Stop Shot              | BW Purge/Timer Shot Size                     |
| BJ Date and Time                | BX Initiate Manual Auto-Refill               |
| BK Operating Mode Name          | BY Active Screen Name                        |
| BL Alarm Status                 | BZ Adjacent Screen Names                     |
| BM Shot/Sequence Count          | B1 A to B Weight Ratio for Previous Dispense |
| BN Active Shot Weight           |  |
| BP Pump Position                |  |



Fig. 40

## Change Operating Mode

The available operating modes are Shot, Sequence, Operator (Manual), Recirculation, and Disabled mode. The active operating mode name will be shown on the Home screen under the date and time. See FIG. 40 on page 54.

1. From the Home screen, press the Select Operating Mode button ().
2. Press the Up Arrow button () or the Down Arrow button () , or repeatedly press the Select Operating Mode button () to scan through the operating modes.
3. Press the Enter button () to accept the selected operating mode or press the Abort/Cancel button () to keep the current mode.



## Change Active Shot Size Definition from Home Screen

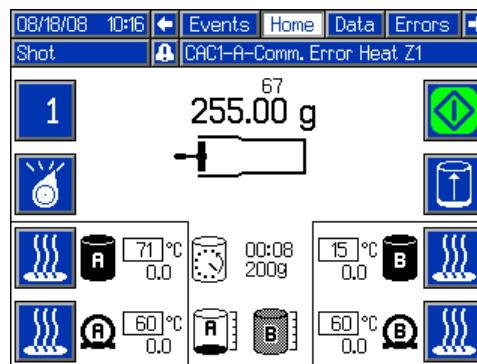

1. Select Shot or Sequence Mode. See **Change Operating Mode**, page 55.
2. Select the shot to change.
3. Press and hold the Shot/Sequence button (BA) for four seconds. Arrows will be displayed next to the shot size (125.36<sub>g</sub>) indicating that the value may be changed.
4. Use the numeric keypad or the arrow buttons to change the shot size.
5. Press the Enter button () to accept the value or press the Abort/Cancel button () to keep the previous value.



## Shot Mode Operation



### Change Active Shot





1. Press the Active Shot/Sequence button (BA).
2. Press the Up Arrow button () or the Down Arrow button () or use the numeric keypad to enter the shot number.



 When typing in the shot number using the numeric keypad, a shot with a zero quantity may be entered. The machine will give an error when the Start/Stop Shot button () is pressed if a zero-quantity shot is selected.





3. Press the Enter button () to accept the new Shot Number or press the Abort/Cancel button () to keep the previous Shot Number.

### Perform a Shot





1. Select Shot Mode. See **Change Operating Mode**, page 55.
2. Press the Start/Stop Shot button () to start a shot.

 The Start/Stop Shot button () changes to the Abort/Cancel button () during the shot. Press the Abort/Cancel button on the screen () or the Abort/Cancel button on the keypad () to cancel the shot if necessary.

When the shot is complete or if the shot is aborted, the Abort/Cancel button on the screen () changes back to the Start/Stop Shot button ()

3. Use the Up Arrow button () and the Down Arrow button () to select the desired sequence. Only non-zero sequences will be available for selection.
4. Press the Enter button () to accept the new sequence or press the Abort/Cancel button () to keep the previous sequence.

### Change Active Position in Sequence

1. Select Sequence Mode. See **Change Operating Mode**, page 55.
2. Press the Active Shot/Sequence button (BA).
3. Use the Up Arrow button () and the Down Arrow button () to select the desired position in the sequence.
4. Press the Enter button () to accept the number or press the Abort/Cancel button () to keep the current number.

### Sequence Mode Operation

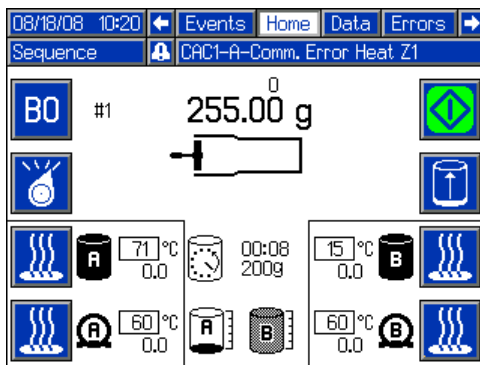

To change the setup of a sequence navigate to Edit Screens #2-#5. See **Screen Navigation Diagram**, page 17.

### Change Active Sequence

1. Select Sequence Mode. See **Change Operating Mode**, page 55.
2. Press and hold the Active Shot/Sequence button (BA) for three seconds.

### Perform a Sequence









1. Select Sequence Mode. See **Change Operating Mode**, page 55.
2. Select the desired sequence.

 If Auto-Sequencing is enabled on the Edit Screens for the Active Sequence, the machine will automatically perform all shots in that sequence when the Start/Stop button is pressed. See **Edit Screens**, page 23.



3. Press the Start/Stop Shot button () to start a shot.

 The Start/Stop Shot button () changes to the Abort/Cancel button () during the shot. Press the Abort/Cancel button on the screen () or the Abort/Cancel button on the keypad () to cancel the shot if necessary.

When the shot is complete or if the shot is aborted, the Abort/Cancel button on the screen () changes back to the Start/Stop Shot button ()

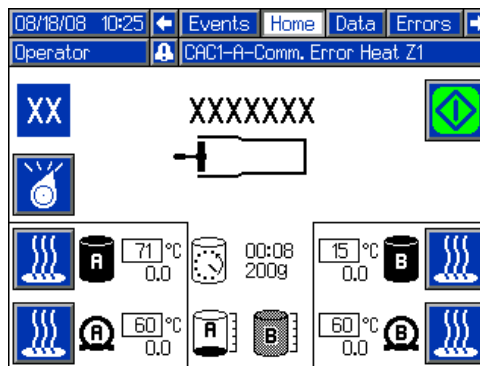

4. If Auto-Sequencing is not enabled for the Active Sequence the next shot in the sequence will be selected. Press the Start/Stop Shot button () to start the shot.
5. Repeat step 4 until the sequence has been completed.

## Operator (Manual) Mode Operation



### Dispense

 Operator (Manual) Mode does not use the pre-defined shots or sequences.

1. Select Operator (Manual) mode. See **Change Operating Mode**, page 55.
2. Press and hold the Start/Stop Shot button () to begin dispensing.
3. Release the Start/Stop Shot button () to stop dispensing.

## Recirculation Mode Operation

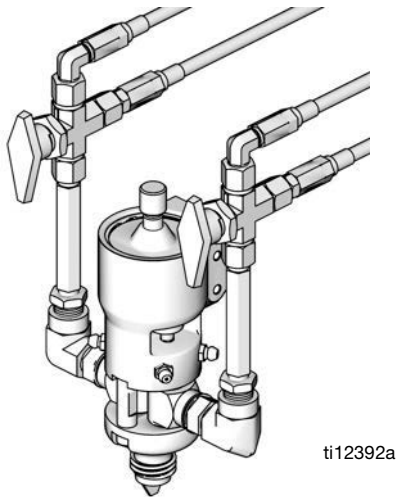

**FIG. 41: Recirculation Valves**

Recirculation mode requires that one 3-way ball valve is installed for each material line. The ball valve must be installed at the dispense head and have fluid lines going from the ball valve back to the tank. See FIG. 41.

In Recirculation mode, the dispense valve is always closed.

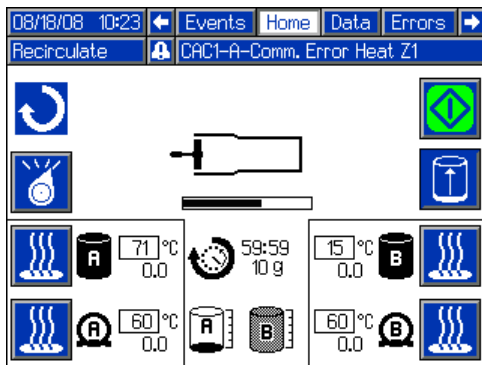



### Recirculate Materials







When Recirculation mode is enabled, both recirculation ball valves must be turned to return material back to the tank. Only turning one valve may result in a pressure imbalance exceeding the machine's maximum working pressure.

1. Turn both 3-way ball valves at the dispense valve so materials will flow back to tank.

2. Ensure system air pressure is at the standard operating setting.
3. Navigate to the Fluid Options Setup Screen. See **Screen Navigation Diagram** on page 17.
4. Configure the shot size, timer duration, and alarm point, then enable the Recirculation Timer. See **Fluid Options, Screen #1** on page 27.
5. Navigate to the Home screen. See **Screen Navigation Diagram** on page 17.
6. Press the Start/Stop Shot button () to begin the recirculation cycle and take the first recirculation shot.

The Start/Stop Shot button () changes to the Abort/Cancel button () while the recirculation shot is dispensing. Press the Abort button to cancel that shot. Recirculation mode will remain active and another recirculation shot will occur at the expiration of the timer.

### Stop Recirculation, If Necessary

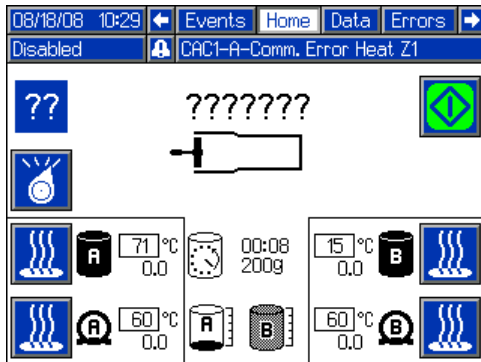

7. Press the Select Operating Mode button () repeatedly to scan through operating modes.
8. Press the Enter button () to accept the selected operating mode or press the Abort/Cancel button () to keep the current mode.
9. If changing modes is cancelled, the machine will remain in recirculation mode but the recirculation cycle is stopped. To restart recirculation, press the Start/Stop Shot button ()
10. When Recirculation mode is stopped, turn the 3-way ball valves at the dispense valve so materials will flow out of the dispense head.

## Disabled Mode Operation



The machine will not dispense in this mode. All outputs to the solenoid valves are disabled and the Start/Stop

Shot button () is inactive. Heat controls remain active.

Pressing the Machine Disable Mode key () will enter Disabled Mode **and** disable heat. Select Disabled mode using the Select Operating Mode button () to enter Disabled Mode **without** disabling heat.

## Data Screens

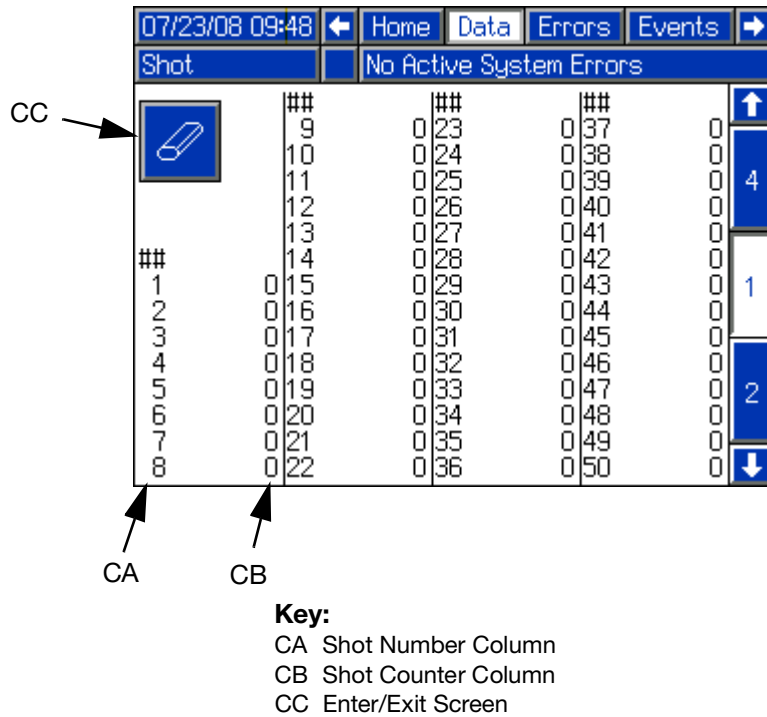



FIG. 42

The data screens show the shot counters for all shots and shot sequences. Data screen #1 shows the shot counters for all shots. Data screens #2-#5 show the shot counters for sequences A through G, with two sequences shown per screen.

### Reset Shot and Sequence Counters

1. Navigate to the correct Data Screen. See **Screen Navigation Diagram** on page 17.
2. Press the Enter/Exit Screen button (CC).
3. Use the arrow keys to navigate to the counter to be reset.
4. Press the Enter button () to erase the selected counter.
5. Repeat steps 3 and 4 as necessary to erase other counters on the same screen.
6. Press the Enter/Exit Screen button (CC) to exit the screen.

## Error Screens

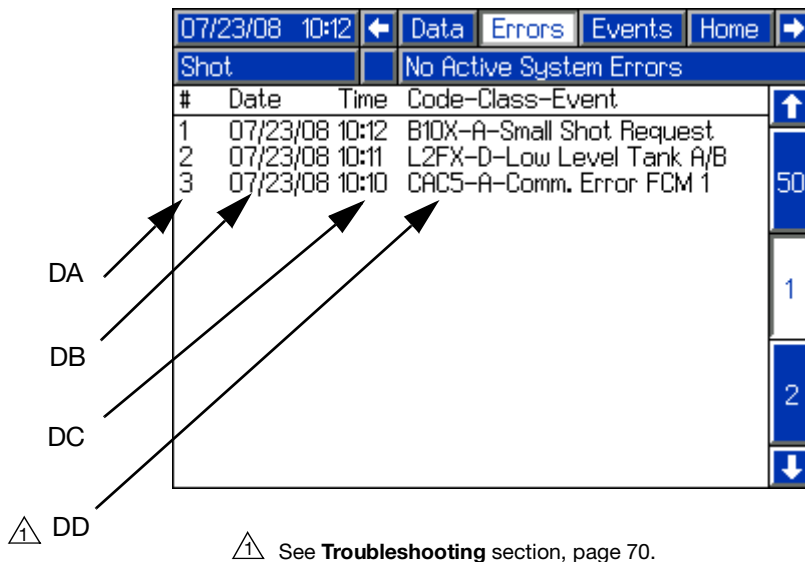

**Key:**

- DA Error Number
- DB Date Error Occurred
- DC Time Error Occurred
- DD Error Details

**FIG. 43**

The Errors Screen tracks all of the errors that have occurred on the machine. The latest error will appear at the top of the list with date, time, and code-class-event information. For more information on the code-class-event information, see **Troubleshooting** section, page 70.

## Events Screen

08/18/08 10:37		←	Errors	Events	Home	Data	→
Shot		CAC1-A-Comm. Error Heat Z1					
#	Date	Time	Code-Class-Event				
1	08/18/08	10:33:30	EJDX-R-System On			↑	
2	08/18/08	10:33:29	EHDX-R-System Off			50	
3	08/18/08	10:32:51	ELOX-R-Calibration				
4	08/18/08	10:32:32	EERX-R-Recirculate			1	
5	08/18/08	10:32:23	EJDX-R-System On				
6	08/18/08	10:32:22	EHDX-R-System Off			2	
7	08/18/08	10:30:57	EBCX-R-Stop Pressed			↓	

NA      NB      NC      ND

**Key:**

- NA Event Number
- NB Date Event Occurred
- NC Time Event Occurred
- ND Event Details

**FIG. 44**

The Events Screen shows a history of events for the machine with details of the event including date and time. The following is a list of events tracked on the Events Screen.

- System Powered On
- System Powered Off
- Shot
- Purge Shot
- Stop Button Pressed
- System Calibrated
- Recirculation Mode entered

## Auto-Refill

See **Fluid Options, Screen #1** on page 27 for a description of each Auto-Refill mode.

With Level Sensors installed, Auto-Refill can be used. There are multiple Auto-Refill modes ranging in function. For details on the different modes, see **Fluid Options, Screen #1** on page 27.





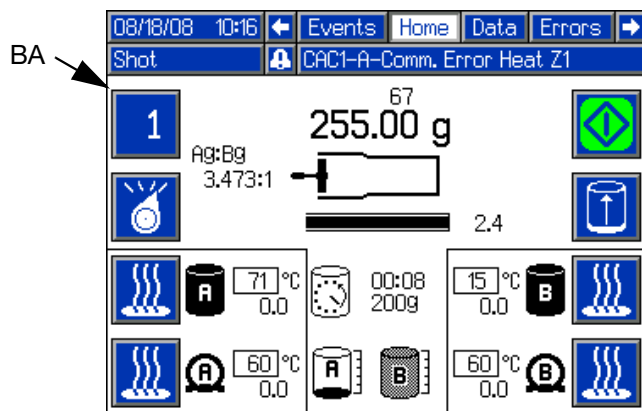

The tank icons on the Home Screen display the status of each tank.



In all Auto-Refill modes other than Manual Auto-Refill, the machine automatically performs the appropriate functions.

### Manually Initiate Auto-Refill



This procedure can be used to initiate auto-refill if Manual Auto-Refill, High Level Auto-Refill, Empty Auto-Refill, or Accumulator mode is enabled. See **Fluid Options, Screen #1** on page 27 for a description of each Auto-Refill mode.

1. Navigate to the Home Screen. See **Screen Navigation Diagram** on page 17.
2. Press the Initiate Auto-Refill button () . The Active Shot/Sequence button (BA) and Select Operating Mode button () will each change to the Auto-Refill Tank Select button ( or ) if a valid Auto-Refill mode is enabled for both tanks.
3. Press the appropriate Auto-Refill Tank Select button or buttons ( and/or ) to select the tanks to refill.

4. Press the Initiate Auto-Refill button () or the Enter button () to confirm.

5. If necessary, press the Abort/Cancel button () to cancel auto-refill.

If an auto-refill is aborted or times out, the software will not initiate a new auto-refill until a manually initiated auto-refill has completed. To complete a manually initiated auto-refill after an aborted or timed out auto-refill, restart at step 2.

### CAUTION

If an auto-refill is stopped and not restarted as described in the previous note, the pumps may be run dry and chemical crossover at the valve may occur.

## Temperature Control

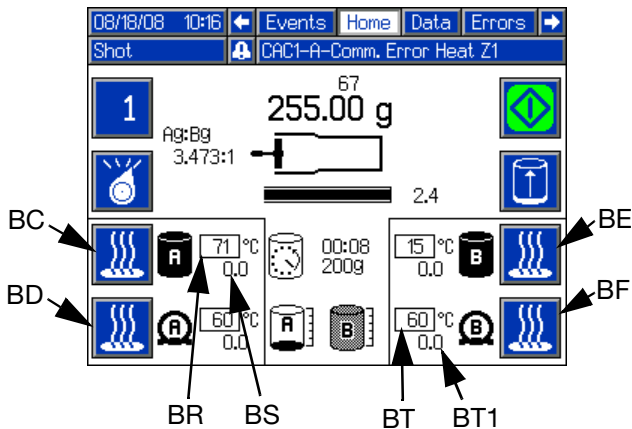

The Tank Fluid Temperature Setpoint (BR), Tank Fluid Temperature (BS), Hose Heater Temperature (BT1), and Hose Heater Temperature Setpoint (BT) display the status of the each of the options. To turn the Tank Blanket Heaters or Hose Heaters on or off, press the Tank or Hose Heater On/Off button (BC, BD, BE, BF). See **Heat Options, Screen #2** on page 29 for more information on temperature control setup.

### Change Heater Temperature Setpoint from Home Screen

Changing the Heater Temperature Setpoint can be done from the Setup screens or from the Home Screen. To change the temperature setpoint for any of the installed tank or hose heaters from the Home Screen, perform the following steps.

1. Press and hold the Tank or Hose Heater On/Off button (BC, BD, BE, BF) for four seconds. The temperature setpoint box will invert colors.
2. Use the numeric keypad to enter the new temperature setpoint.

 The maximum allowable set point is 160°F (71°C) and the minimum is 60°F (15°C).

3. Press the Enter button () to accept the new value.

## Purge Timer

 Purge Timer settings can be changed from the Fluid Options Setup Screen, see page 27.

The Purge Timer automatically issues a shot after the machine has been idle a set amount of time to clear the static mixer of partially cured material. After a shot is finished, the clock counts down from the value set in the setup screens. The Purge Alarm will sound prior to the purge shot. When the timer reaches the Purge Alarm time, the Purge Alarm will sound until the timer reaches zero or the user issues a shot. When the timer reaches 00:00, the machine will issue a shot equal to the amount set for the purge timer shot size and that is shown under the timer. The timer will reset and the process will repeat.



# USB Data

## USB Logs

During operation, PR70 stores system and performance related information to memory in the form of log files. PR70 maintains two log files: error logs and event logs. Follow the **Download Procedure** on this page to retrieve log files.

### Error Log

The error log file name is 1-ERROR.CSV and is stored in the DOWNLOAD folder.

The error log maintains a record of the last 1,000 errors.

- Error occurrence date
- Error occurrence time
- Error description

### Event Log

The event log file name is 2-EVENT.CSV and is stored in the DOWNLOAD folder.

The event log maintains a record of the last 10,000 events.

An event entry is stored on the completion of an event. The following data, when applicable, is stored:

- Event date
- Event time
- Event description
- Shot Weight (grams)
- Dispense duration (seconds)
- Material A temperature
- Material B temperature
- Temperature units

## Download Procedure

1. Insert USB flash drive into USB port.

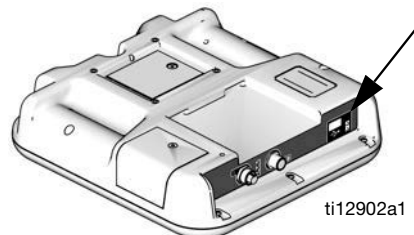

2. The menu bar and USB indicator lights indicate that the USB is downloading files. Wait for USB activity to complete.
3. Remove USB flash drive from USB port.
4. Insert USB flash drive into USB port of computer.
5. The USB flash drive window automatically opens. If it does not, open USB flash drive from within Windows<sup>®</sup> Explorer.
6. Open Graco folder.
7. Open system folder. If downloading data from one than one system, there will be more than one folder. Each folder is labeled with the corresponding serial number of the ADM (The serial number is on the back of the ADM.)
8. Open DOWNLOAD folder.
9. Open the DATA folder labeled with the highest number. The highest number indicates the most recent data download.
10. Open log file. Log files open in Microsoft<sup>®</sup> Excel by default as long as the program is installed. However, they can also be opened in any text editor or Microsoft<sup>®</sup> Word.

 All USB logs are saved in Unicode (UTF-16) format. If opening the log file in Microsoft Word, select Unicode encoding.

# Pressure Relief Procedure



1. Place a waste container below the dispense valve.
2. Navigate to the Manual screen. See **Screen Navigation Diagram** on page 17.
3. Press the Open Dispense Valve button on the Manual screen to relieve chemical pressure.
4. Press the Machine Disable Mode button ()
5. Press the system air pressure relief switch (106) down to stop air supply and to vent air pressure in the machine. It is the yellow tab at the left, rear of the machine. The hole in the tab should be visible.
6. If necessary, run a lock through the hole to lock the tab in place. This prevents the system air pressure from being inadvertently enabled.

# Shutdown



If the machine is to remain idle for an extended period of time, perform the following steps.

1. Place a waste container below the dispense valve.
2. If installed, remove static mixer from the end of the dispense valve.
3. Place a container below the dispense valve and activate a small shot to flush mixed material out of the valve.
4. Relieve pressure. See **Pressure Relief Procedure**.
5. With a clean rag and cotton swabs, clean the end of the dispense valve.
6. Install nightcap on the dispense valve.

# Maintenance



## Schedule

Action	Schedule	Procedure
Check Water/Air Separator	Daily before use	1. Check water/air separator for water. 2. Open valve at base of water/air separator to purge water.
Check Desiccant Dryer (only installed if chemical is moisture sensitive)	Daily before use	1. Check the color of the desiccant. 2. Replace as required.
Check Tanks	Daily before use	1. Check material levels and refill as necessary. 2. Verify the material reservoirs are vented properly.
Check Dispensing Ratio	Daily before use or as required	See <b>Calibrate Dispense Weight Ratio (PR70v only)</b> page 44 and <b>Shot Calibration</b> page 47. If ratio accuracy is critical to the application, perform ratio check procedure daily before use.
Clean Pump Shafts	Daily after shutdown	See <b>Clean the Pump Shafts</b> on this page
Clean Dispense Head	Daily	See <b>Shutdown</b> on page 66.
Lubricate pneumatic air motor	Every 8 hours	See <b>Lubricate Pneumatic Air Motor</b> on page 68.
Lubricate pneumatic air motor 01/0368-1/11 gear box	Every 2 days Every 6 months (or 2500 operating hours)	See <b>Lubricate Gear Box of Pneumatic Air Motor 01/0368-1/11</b> on page 68.
Flush pneumatic air motor 82/0216/11	As required	<b>Flush Pneumatic Air Motor 82/0216/11</b> on page 68.
Disassemble and Clean Dispense Head	As required	See <b>Disassemble and Clean the Dispense Head</b> on this page
Upgrade Advanced Display Module and Fluid Control Module Software	As required	See <b>Install Upgrade Token</b> on this page

## Clean the Pump Shafts

1. Press down air pressure relief switch at left, rear of machine.
2. Press the Machine Disable Mode key ()
3. Push piston block to fully retracted position.

Clean both pump shafts with solvent and lubricate with mesamoll or silicon oil.

## Disassemble and Clean the Dispense Head

1. Relieve pressure. See **Pressure Relief Procedure**, page 66.
2. Remove dispense head from machine.
3. Dismantle the dispense head. See MD2 Dispense Valve manual referenced at the beginning of this manual.
4. Clean all parts.

- Lubricate all parts with a thin coat of mesamoll or silicon oil.
- Reassemble dispense head. See manual 312185 for details.
- Reinstall dispense head on machine.

## Flush Pneumatic Air Motor 82/0216/11

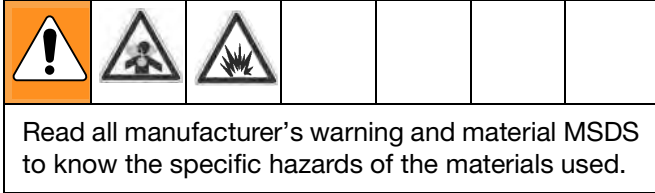

If the motor is sluggish or inefficient, flush it with a non-flammable solvent in a well ventilated area. The recommended solvent for air motors and lubricated pumps is Gast® Flushing Solvent (Part No. AH255 or AH255A) or Inhibisol® Safety Solvent.

- Disconnect the air line and muffler.
- Add several teaspoons of solvent or spray the solvent directly into the motor.
- Rotate the shaft by hand in both directions for a few minutes.
- Reconnect the air line, and slowly increase the air pressure until there is no trace of solvent in the exhaust air.
- Re-lubricate the motor with a squirt of light-weight oil in the chamber.

## Lubricate Pneumatic Air Motor



If an air line lubricator is not installed, the air motor must manually be lubricated every eight hours. Lubricate the agitator air motor by placing 10-20 drops of SAE #10 light oil in the air inlet of the motor. Run the agitator for about 30 seconds.

## Lubricate Gear Box of Pneumatic Air Motor 01/0368-1/11

**NOTE:** This section does not apply to pneumatic air motors 24J182 or 24J183.

### Check Oil Level

Perform the following procedure every two days.

- Remove oil fill plug and check oil level. The proper oil level is indicated on the outside of the gear box housing.
- If the oil level is low, add 140-weight SAE gear oil or a high quality worm gear lubricant.
- Replace fill plug and torque to 20 ft-lb (27 N•m).

**NOTE:** Gear box oil is easiest to drain immediately following motor operation while oil is still warm.

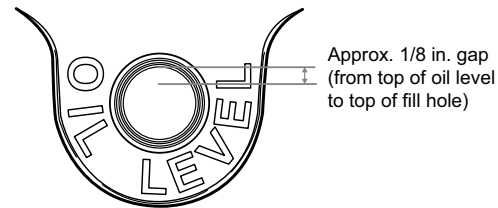

FIG. 45

**NOTE:** Do not overfill. Overfilling may cause oil to leak out of vent cap on top of gear box.

### Replace Oil

Perform the following procedure after the first 250 hours of operation. After that, perform every six months or every 2500 operating hours.

- Remove gear box and drain oil.
- Refill gear box with 140-weight SAE gear oil or a high quality worm gear lubricant.
- Replace fill plug and torque to 20 ft-lb (27 N•m).

**NOTE:** Replace gear oil more often if the environment causes oil to become contaminated during use.

## Install Upgrade Token

This procedure applies to the Advanced Display Module (ADM) and Fluid Control Module (FCM).

1. Disconnect power to the module.
2. Remove token access panel. See FIG. 46.

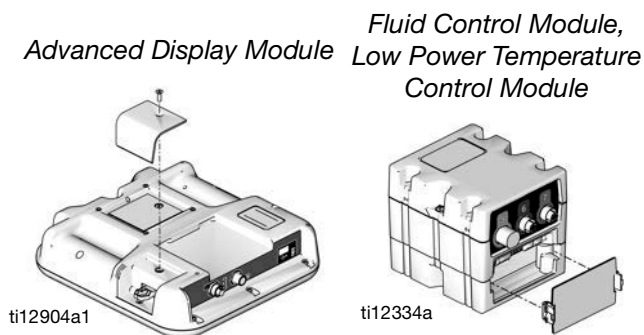

**FIG. 46: Remove Access Panel**

3. Insert and press firmly token into slot.

**NOTE:** There is no preferred orientation of the token.

4. Restore power to the module. The red LED will flash rapidly to signal that software is loading. When the red LED stops flashing, the software is done loading.
5. Disconnect power to the module.
6. Remove the token.
7. Replace token access panel.
8. Restore power to the module.
9. Repeat for each module that needs to be updated.
10. Verify new software versions on the **System Data Screen** screen. See page 35.

## Light Tower (Optional)

Signal	Description
Green on only	System is powered up and there are no error conditions present
Yellow on	An advisory exists
Red flashing	A deviation exists
Red on	The system is shut down due to an alarm occurring.

Errors include advisories, deviations, or alarms, so green will only be on when none of these occur. A yellow light can be on at the same time as red (flashing or solid on) when an advisory exists at the same time as a deviation or alarm.

# Troubleshooting

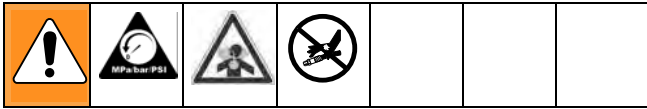

Before starting any troubleshooting procedures, perform the following procedure. See PR70 and PR70v Repair - Parts manual referenced at the beginning of this manual for detailed procedures.

1. Relieve pressure. See **Pressure Relief Procedure**, page 66.

2. Disconnect AC power from the machine.
3. Allow the machine to cool if the machine has a heat control option.

Try the recommended solutions in the order given for each problem to avoid unnecessary repairs. Verify all circuit breakers, switches, and controls are properly set and wiring is correct.

Problem	Cause	Solution
Display Module completely dark	No power	Verify rear AC Power switch is ON.
	Fuse blown	Replace machine fuses.
	Loose connection	Tighten 5-pin cable on Display Module.
	Bad display module	Replace Display Module.
No or incorrect amount of material dispensed from either side.	Ball valve closed (if installed)	Open tank ball valve.
	Tank empty	Fill tank with material.
	Tank clogged	Verify no obstruction in the tank.
	Air in material	Prime the machine until the air is removed.
	Check valve malfunction	Remove; clean or replace check valve.
Piston stalled	Piston worn or broken	Remove and replace piston if worn.
	Input air reduced or removed	Reconnect input air line to machine. Increase air pressure regulator adjustment.
	Mixer blocked	Replace static mixer. Incorporate purge timer or decrease purge timer delay to prevent mixer blockage.
	Open Dispense Valve (ODV) adjustment too late	Readjust the ODV setting to occur sooner.
	Blocked check valve	Remove check valve; clean and replace.
Significant material leaking from pump rear seal	Air cylinder failure	Remove air cylinder and reinstall air cylinder parts as necessary.
	Pump shaft worn and/or shaft seal worn	Remove pump shaft assembly, and reinstall rear pump rebuild kit.

<b>Problem</b>	<b>Cause</b>	<b>Solution</b>
Material dispensed not correct weight	Specific gravity of one or more of the two materials has changed since calibration	Recalibrate machine.
	Machine air pressure has changed since calibration.	Readjust air pressure regulator to value used when machine was calibrated, or recalibrate machine.
	Not enough material in one or more tanks	Check tank levels; fill and prime as necessary.
	Mixer has slight obstruction	Replace static mixer. Prime machine.
	Check valve malfunction	Remove check valve; clean or replace as necessary.
	Piston worn or broken	Replace piston.
Machine dispensing off ratio	One tank is empty	Check tank levels. Add material if necessary.
	Tank ball valve closed	Open tank ball valve. Prime machine.
	Machine out of phase	Re-phase machine.
	Check valve malfunction	Remove check valve; clean or replace as necessary.
	Piston worn or broken	Replace piston.
Pumps drawing material back from valve hose	Check valve stuck open	Remove check valve, clean or replace as necessary.

## Error Codes

<b>Code-Class-Event Shown on Errors Screen</b>	<b>Description</b>	<b>System Behavior Ref</b>
050X-A-Improper System Cal	Improper Calibration	5
06CX-A-Invalid Key Token	No or Invalid Key Token	4
A401-A-Over Current Z1	Heater Over Current, Zone #1	7
A402-A-Over Current Z2	Heater Over Current, Zone #2	7
A403-A-Over Current Z3	Heater Over Current, Zone #3	7
A404-A-Over Current Z4	Heater Over Current, Zone #4	7
A4C1-A-Fan Over Current Z1	High Relay 2 Current, Zone #1	7
A4C2-A-Fan Over Current Z2	High Relay 2 Current, Zone #2	7
A4C3-A-Fan Over Current Z3	High Relay 2 Current, Zone #3	7
A4C4-A-Fan Over Current Z4	High Relay 2 Current, Zone #4	7
A701-A-Heater Fault Z1	Unexpected Heater Current, Zone #1	7
A702-A-Heater Fault Z2	Unexpected Heater Current, Zone #2	7
A703-A-Heater Fault Z3	Unexpected Heater Current, Zone #3	7
A704-A-Heater Fault Z4	Unexpected Heater Current, Zone #4	7
A7C1-A-Fan Output Fault Z1	Unexpected Relay 2 Current, Zone #1	7
A7C2-A-Fan Output Fault Z2	Unexpected Relay 2 Current, Zone #2	7
A7C3-A-Fan Output Fault Z3	Unexpected Relay 2 Current, Zone #3	7
A7C4-A-Fan Output Fault Z4	Unexpected Relay 2 Current, Zone #4	7
B10X-A-Small Shot Request	Less Than Minimum Shot Requested	5
CAC1-A-Comm. Error Heat Z1	Communication Error, Heat Zone #1	1
CAC2-A-Comm. Error Heat Z2	Communication Error, Heat Zone #2	1
CAC3-A-Comm. Error Heat Z3	Communication Error, Heat Zone #3	1
CAC4-A-Comm. Error Heat Z4	Communication Error, Heat Zone #4	1
CAC5-A-Comm. Error FCM 1	Communication Error, FCM3 #1	2
CAC6-A-Comm. Error FCM2	Communication Error, FCM3 #2	3
DEFX-A-Piston Timeout	Piston Stroke Timeout	5
DJ0X-D-Linear Sensor Fault	Bad Linear Position Sensor	6
F2A-Low Flow A Side	Low A Side Fluid Flow, relative to calibration and user-input allowable variance. See <b>Dispense Check Options, Screen #4</b> on page 32.	6





Code-Class-Event Shown on Errors Screen	Description	System Behavior Ref
F2B-Low Flow B Side	Low B Side Fluid Flow, relative to calibration and user-input allowable variance. See <b>Dispense Check Options, Screen #4</b> on page 32.	6
F2FX-D-Delta Velocity Minus	Delta Velocity Minus	6
F3FX-D-Delta Velocity Plus	Delta Velocity Plus	6
F6A-Flow Meter A Problem	Flow Meter A Problem, or bad connection between Fluid Control Module and Flow Meter A	6
F6B-Flow Meter B Problem	Flow Meter B Problem, or bad connection between Fluid Control Module and Flow Meter B	6
L2AX-D-Low Level Tank A	Low Material Level, Tank A	6
L2BX-D-Low Level Tank B	Low Material Level, Tank B	6
L2FX-D-Low Level Tank A/B	Low Material Level, Both Tanks	6
L8AX-D-Refill Timeout A	Auto Refill Failed, A Side	6
L8AX-D-Refill Timeout B	Auto Refill Failed, B Side	6
P2AX-D-Low Pressure A	A Side Low Pressure, relative to calibration and user-input allowable variance. See <b>Dispense Check Options, Screen #4</b> on page 32.	6
P2BX-D-Low Pressure B	B Side Low Pressure, relative to calibration and user-input allowable variance. See <b>Dispense Check Options, Screen #4</b> on page 32.	6
P3AX-D-High Pressure A	A Side High Pressure, relative to calibration and user-input allowable variance. See <b>Dispense Check Options, Screen #4</b> on page 32.	6
P3BX-D-High Pressure B	B Side High Pressure, relative to calibration and user-input allowable variance. See <b>Dispense Check Options, Screen #4</b> on page 32.	6
P6AX-D-Pressure Fault A	Problem with A Side Piston Pressure Transducer or Transducer Connection	6
P6BX-D-Pressure Fault B	Problem with B Side Piston Pressure Transducer or Transducer Connection	6
P6DX-D-Pressure Fault A/B	Problem with A and B Side Piston Pressure Transducer or Transducer Connection	6

<b>Code-Class-Event Shown on Errors Screen</b>	<b>Description</b>	<b>System Behavior Ref</b>
P7DX-D-Out of Phase	Machine Out of Phase, relative to calibration and user-input allowable variance. See <b>Dispense Check Options, Screen #4</b> on page 32.	6
R2-A:B Ratio Low	A:B Ratio is low, relative to calibration and user-input allowable variance. See <b>Dispense Check Options, Screen #4</b> on page 32.	6
R3-A:B Ratio High	A:B Ratio is high, relative to calibration and user-input allowable variance. See <b>Dispense Check Options, Screen #4</b> on page 32.	6
T201-D-Low Material Temp Z1	Material Below Temperature, Zone #1	8
T202-D-Low Material Temp Z2	Material Below Temperature, Zone #2	8
T203-D-Low Material Temp Z3	Material Below Temperature, Zone #3	8
T204-D-Low Material Temp Z4	Material Below Temperature, Zone #4	8
T401-A-High Material Temp Z1	Material Over Temperature, Zone #1	7
T402-A-High Material Temp Z2	Material Over Temperature, Zone #2	7
T403-A-High Material Temp Z3	Material Over Temperature, Zone #3	7
T404-A-High Material Temp Z4	Material Over Temperature, Zone #4	7
T4C1-A-Blanket Over Temp Z1	Blanket Over Temperature, Zone #1	7
T4C2-A-Blanket Over Temp Z2	Blanket Over Temperature, Zone #2	7
T4C3-A-Blanket Over Temp Z3	Blanket Over Temperature, Zone #3	7
T4C4-A-Blanket Over Temp Z4	Blanket Over Temperature, Zone #4	7
T601-A-Material RTD Fault Z1	Material RTD Fault, Zone #1	7
T602-A-Material RTD Fault Z2	Material RTD Fault, Zone #2	7
T603-A-Material RTD Fault Z3	Material RTD Fault, Zone #3	7
T604-A-Material RTD Fault Z4	Material RTD Fault, Zone #4	7
T6C1-A-Blanket RTD Fault Z1	Blanket RTD Fault, Zone #1	7
T6C2-A-Blanket RTD Fault Z2	Blanket RTD Fault, Zone #2	7
T6C3-A-Blanket RTD Fault Z3	Blanket RTD Fault, Zone #3	7
T6C4-A-Blanket RTD Fault Z4	Blanket RTD Fault, Zone #4	7
T801-D-No Heat Z1	No Temperature Rise, Zone #1	8
T802-D-No Heat Z2	No Temperature Rise, Zone #2	8
T803-D-No Heat Z3	No Temperature Rise, Zone #3	8

Code-Class-Event Shown on Errors Screen	Description	System Behavior Ref
T804-D-No Heat Z4	No Temperature Rise, Zone #4	8
T901-A-Temp Switch Cutoff Z1	Over Temp Switch Open, Zone #1	7
T902-A-Temp Switch Cutoff Z2	Over Temp Switch Open, Zone #2	7
T903-A-Temp Switch Cutoff Z3	Over Temp Switch Open, Zone #3	7
T904-A-Temp Switch Cutoff Z4	Over Temp Switch Open, Zone #4	7
T9C1-A-Control Shutdown Z1	PCB Over Temperature, Zone #1	7
T9C2-A-Control Shutdown Z2	PCB Over Temperature, Zone #2	7
T9C3-A-Control Shutdown Z3	PCB Over Temperature, Zone #3	7
T9C4-A-Control Shutdown Z4	PCB Over Temperature, Zone #4	7
WM01-A-Current Fault Z1	High Relay 1 Current, Zone #1	7
WM02-A-Current Fault Z2	High Relay 1 Current, Zone #2	7
WM03-A-Current Fault Z3	High Relay 1 Current, Zone #3	7
WM04-A-Current Fault Z4	High Relay 1 Current, Zone #4	7
WMC1-A-Control Fault Z1	Unexpected Relay 1 Current, Zone #1	7
WMC2-A-Control Fault Z2	Unexpected Relay 1 Current, Zone #2	7
WMC3-A-Control Fault Z3	Unexpected Relay 1 Current, Zone #3	7
WMC4-A-Control Fault Z4	Unexpected Relay 1 Current, Zone #4	7

### System Behavior Descriptions

System Behavior Reference	System Behavior Description
1	When this error is generated, a pop-up with the error-code will be shown until it is acknowledged by pressing the Enter button (↵). The heat control will be turned off, any auto-sequencing in progress will be stopped, and the foot switch will be disabled until the error-code is acknowledged. When the error condition is cleared, the heat control may be turned back on from the Home screen. This error will not disable purge or recirculation operation.
2	When this error is generated, a pop-up with the error-code will be shown until it is acknowledged by pressing the Enter button (↵). All physical machine operation will be disabled until the error condition is corrected. The display module can still be used but all machine commands sent will be ignored.
3	When this error is generated, a pop-up with the error-code will be shown until it is acknowledged by pressing the Enter button (↵). Any auto-sequencing in progress will be stopped and the foot switch will be disabled until the error-code is acknowledged. This error will not disable purge or recirculation operation. All features dependent on Fluid Control Module #2 will be disabled until the error condition is corrected.

<b>System Behavior Reference</b>	<b>System Behavior Description</b>
4	When this error is generated, a pop-up with the error-code will be shown continuously until the error condition is corrected. The machine and display module are completely disabled until the error condition is corrected.
5	When this error is generated, a pop-up with the error-code will be shown. Any auto-sequencing, purge timer or recirculation timer operation in progress will be stopped and the foot switch will be disabled until the error-condition is cleared. The error-code pop-up will be shown until the error condition is cleared. When the error condition is cleared, all options may be turned back on.
6	When this error is generated, a pop-up with the error-code will be shown until it is acknowledged by pressing the Enter button (  ). Any auto-sequencing in progress will be stopped, and the foot switch will be disabled until the error-code is acknowledged. Once the error-code pop-up is acknowledged, the machine will return to normal operation. The error will be shown in the Errors screen until the condition is cleared. The error-code pop-up will not reappear unless the error condition is cleared and then reappears. This error will not disable purge or recirculation operation.
7	When this error is generated, a pop-up with the error-code will be shown until it is acknowledged by pressing the Enter button (  ). All heat options will be turned off, any auto-sequencing in progress will be stopped, and the foot switch will be disabled until the error-code is acknowledged. When the error condition is cleared, the heat control may be turned back on from the Home screen. This error will not disable purge or recirculation operation.
8	When this error is generated, a pop-up with the error-code will be shown until it is acknowledged by pressing the Enter button (  ). All heat options will remain on, any auto-sequencing in progress will be stopped, and the foot switch will be disabled until the error-code is acknowledged. This error will not disable purge or recirculation operation.

# Kits

## Mixer and Shroud Options

Part	Description
LC0063	Mixer, 3/16 in. (4.8 mm) x 32, 10 Mixers with shroud
LC0057	Mixer, 1/4 in. (6.5 mm) x 24, 10 Mixers with shroud
LC0058	Mixer, 3/8 in. (9.8 mm) x 24, 10 Mixers with shroud
LC0059	Mixer, 3/8 in. (9.8 mm) x 36, 10 Mixers with shroud
LC0060	Mixer, 3/8 in. (9.8 mm) Combo, 10 Mixers with shroud
LC0061	Mixer, 3/16 in. (4.8 mm) x 32 Luer Lock, 10 Mixers with shroud
LC0062	Mixer, 1/4 in. (6.5 mm) x 24 Luer Lock, 10 Mixers with shroud
LC0077	Mixer, 3/16 in. (4.8 mm) x 32, 50 Mixers
LC0078	Mixer, 1/4 in. (6.5 mm) x 24, 50 Mixers
LC0079	Mixer, 3/8 in. (9.8 mm) x 24, 50 Mixers
LC0080	Mixer, 3/8 in. (9.8 mm) x 36, 50 Mixers
LC0081	Mixer, 3/8 in. (9.8 mm) combo, 50 Mixers
LC0083	Mixer, 1/4 in. (6.5 mm) x 24 Luer Lock, 50 Mixers
LC0082	Mixer, 3/16 in. (4.8 mm) x 32 Luer Lock, 50 Mixers
LC0084	Mixer, 3/16 in. (4.8 mm) x 32, 250 Mixers
LC0085	Mixer, 1/4 in. (6.5 mm) x 24, 250 Mixers
LC0086	Mixer, 3/8 in. (9.8 mm) x 24, 250 Mixers
LC0087	Mixer, 3/8 in. (9.8 mm) x 36, 250 Mixers
LC0088	Mixer, 3/8 in. (9.8 mm) combo, 250 Mixers
LC0089	Mixer, 3/16 in. (4.8 mm) x 32 Luer Lock, 250 Mixers
LC0090	Mixer, 1/4 in. (6.5 mm) x 24 Luer Lock, 250 Mixers

## MD2 Valve Kits

 See MD2 Dispense Valve instruction manual referenced at the beginning of this manual for installation instructions or for more information.

Part	Description
255217	MD2, kit rebuild, air cylinder
255218	MD2, kit rebuild, back-end of wet section (no needle or seat)
255219	MD2, Soft Seat rebuild, needle and nose
255220	MD2, convert Soft Seat nose to Hard Seat (Hard Seat rebuild), needle and nose

## Machine Rebuild Kits

 See the PR70™ and PR70v™ Repair-Parts manual referenced at the beginning of this manual for parts included in each kit.

Part	Description
LC0091	3.0 in. Air Cylinder rebuild kit
LC0092	4.5 in. Air Cylinder rebuild kit
LC0093	Check Valve rebuild kit, Stainless Steel Ball
LC0318	Check Valve rebuild kit, Carbide Ball
LC0094	Rear Pump Seal rebuild kit

## Tank Accessories

See the PR70™ and PR70v™ Feed Systems Instructions-Parts Manual for tank accessories. See **Related Manuals** on page 3 for manual number.

## Light Tower Accessory

Part	Description
255468 *	Light Tower Kit

\* Only available with ADM models.

## External Control Interface Connection Kit

Part	Description
LC0008	Cord, I/O Interface and Splitter (Connector #1)
120997	Cord, Shot SEL (Connector #2)

## PR70™ and PR70v™ ISO Lube Recirculation Kit

Part	Description
25U135	PR70 ISO Lube Recirculation Kit - With 230 VAC Pump
25U137	PR70 ISO Lube Recirculation Kit - Without Pump
25U199	PR70 ISO Lube Recirculation Kit - With 120 VAC Pump

# Dimensions

## Machine with On-Board Tanks

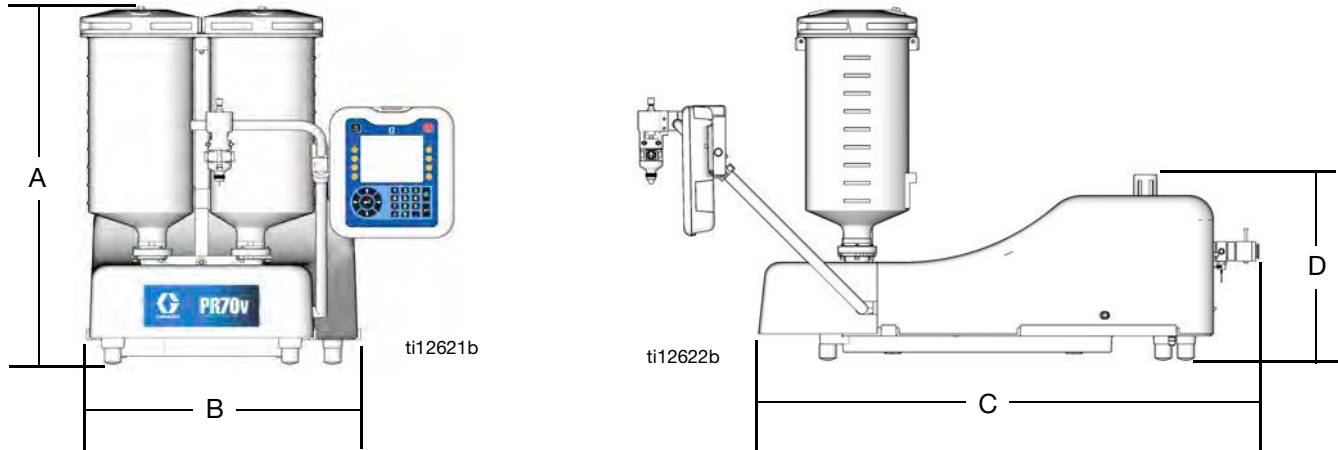

### PR70

Ref	† Assembly Dimensions, in. (mm)				
	Polyethylene Tanks		◆ Stainless Steel Tanks		
	No Agitators	With Agitators	3 L	7.5 L, No Agitators	7.5 L, with Agitators
A	26.4 (670)	38.6 (980)	28.2 (716)	38.2 (970)	39.9 (1013)
B	18.5 (470)	18.5 (470)	15.5 (394)	15.5 (394)	15.5 (394)
C	30.6 (778)	30.6 (778)	30.6 (778)	30.6 (778)	30.6 (778)
D	13.4 (340)	13.4 (340)	13.4 (340)	13.4 (340)	13.4 (340)

### PR70v

Ref	† Assembly Dimensions, in. (mm)				
	Polyethylene Tanks		◆ Stainless Steel Tanks		
	No Agitators	With Agitators	3 L, No Agitators	7.5 L, No Agitators	7.5 L, with Agitators
A	30.0 (762)	39.4 (1001)	29.0 (737)	39.0 (991)	40.6 (1031)
B	20.9 (531)	20.9 (531)	20.9 (531)	20.9 (531)	20.9 (531)
C	38.6 (980)	38.6 (980)	38.6 (980)	38.6 (980)	38.6 (980)
D	14.3 (363)	14.3 (363)	14.3 (363)	14.3 (363)	14.3 (363)

† Assembly dimensions listed are maximum for all assemblies under the given title.

◆ On-board stainless steel tank dimensions include ball valves and vacuum de-gas in maximum height calculation.

## Machine with Off-Board Tanks

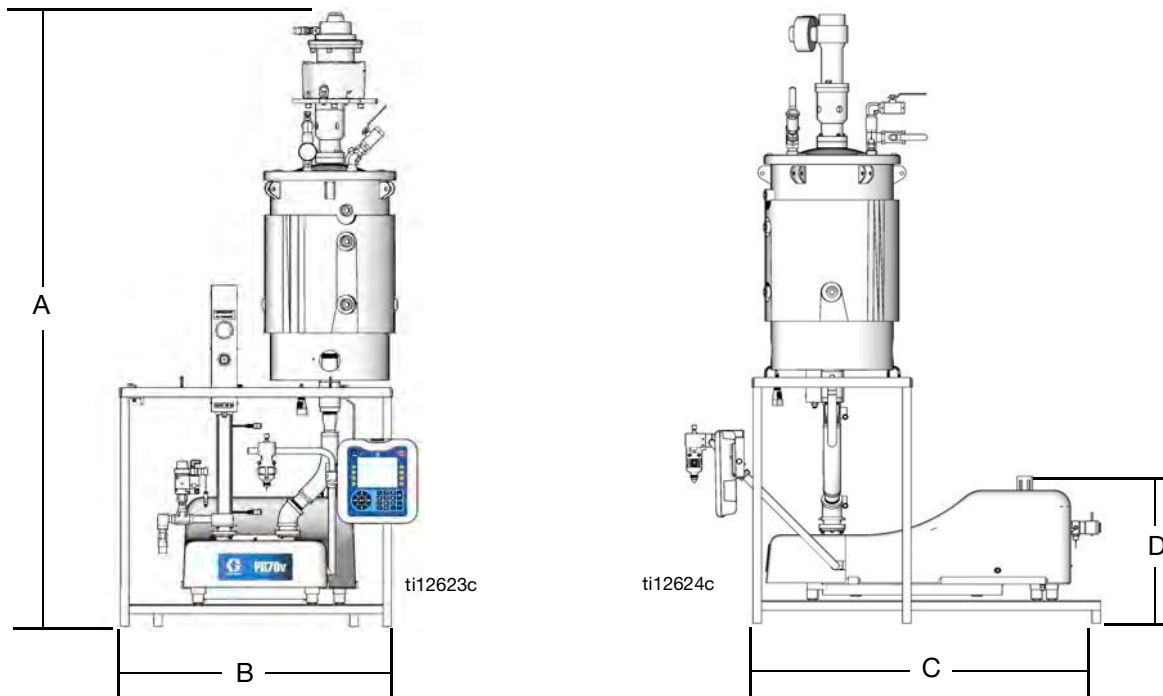

### PR70

Ref	† Assembly Dimensions, in. (mm)			
	30 L Tank		60 L Tank	
	No Agitators	With Agitators	No Agitators	With Agitators
A	59.8 (1519)	87.0 (2210)	67.5 (1714)	94.7 (2405)
B	32.1 (815)	32.1 (815)	32.1 (815)	32.1 (815)
C	29.3 (744)	29.3 (744)	29.3 (744)	29.3 (744)
D	16.0 (406)	16.0 (406)	16.0 (406)	16.0 (406)

### PR70v

Ref	† Assembly Dimensions, in. (mm)			
	30 L Tank		60 L Tank	
	No Agitators	With Agitators	No Agitators	With Agitators
A	59.8 (1519)	87.0 (2210)	67.5 (1714)	94.7 (2405)
B	32.1 (815)	32.1 (815)	32.1 (815)	32.1 (815)
C	40.1 (1019)	40.1 (1019)	40.1 (1019)	40.1 (1019)
D	17.0 (432)	17.0 (432)	17.0 (432)	17.0 (432)

† Assembly dimensions listed are maximum for all assemblies under the given title.

# Technical Data

Metering Pump Effective Area	80 to 960 mm <sup>2</sup> (0.124 to 1.49 in. <sup>2</sup> ) per side
Small Air Cylinder Effective Area	4560 mm <sup>2</sup> (7.07 in. <sup>2</sup> )
Large Air Cylinder Effective Area	10260 mm <sup>2</sup> (15.9 in. <sup>2</sup> )
Maximum Stroke Length	38.1 mm (1.50 in.)
Minimum Stroke Length	5.8 mm (0.23 in.)
Volume per Cycle	2 to 70 cc (0.12 to 4.3 in. <sup>3</sup> )
Pump Cycles per 1 L (0.26 gal)	14.3 to 500 cycles (varies by piston size)
Ratios (fixed)	1:1 to 12:1 (depending upon cylinders selected)
Maximum Fluid Working Pressure	3000 psi (20.7 MPa, 207 bar)
Maximum Air Input Pressure	100 psi (0.7 MPa, 7 bar)
Maximum Cycle Rate	30 cpm
Maximum Operating Temperature	70°C (160°F), nylon pistons 50°C (120°F) UHMWPE pistons or PE Tanks
Air Inlet Size	1/4 NPT female
Pump Fluid Outlet Size	-03, -04, -06, -08 or -12 JIC fittings for 3/16 in. (4.8 mm), 1/4 in. (6.4 mm), 3/8 in. (9.5 mm), 1/2 in. (12.7 mm), 3/4 in. (19.1 mm) hoses
Wetted Parts	303/304, 17-4 PH, hard chrome, Chromex™, carbide, Chemical Resistant O-rings, PTFE, nylon, UHMWPE
Weight	55 kg (120 lb) typical with two 7.5 L tanks 150 kg (330 lb) typical with two 60 L tanks
Sound Pressure Level (at typical operator station for machine mounted Dispense Valve)	82 dBA
Compressed Air	Less than 10 scfm typical (varies with cycle times)
Electrical Power	<ul style="list-style-type: none"> <li>• 100-240 V 50/60Hz, 1 phase for machine – 80 Watts</li> <li>• 208-240V 50/60Hz, 1 phase for heat – 11 kW max</li> <li>• 120 or 240 VAC 50/60Hz 1 phase for on-board agitators, 80 Watts</li> <li>• 240 VAC 50/60Hz 1 phase for off-board agitators, 600 Watts</li> </ul>

Gast® is registered trademark of Gast Manufacturing.

Inhibisol® is a registered trademark of Penetone Corp.



# California Proposition 65

## CALIFORNIA RESIDENTS

 **WARNING:** Cancer and reproductive harm – [www.P65warnings.ca.gov](http://www.P65warnings.ca.gov).

# Graco Standard Warranty

Graco warrants all equipment referenced in this document which is manufactured by Graco and bearing its name to be free from defects in material and workmanship on the date of sale to the original purchaser for use. With the exception of any special, extended, or limited warranty published by Graco, Graco will, for a period of twelve months from the date of sale, repair or replace any part of the equipment determined by Graco to be defective. This warranty applies only when the equipment is installed, operated and maintained in accordance with Graco's written recommendations.

This warranty does not cover, and Graco shall not be liable for general wear and tear, or any malfunction, damage or wear caused by faulty installation, misapplication, abrasion, corrosion, inadequate or improper maintenance, negligence, accident, tampering, or substitution of non-Graco component parts. Nor shall Graco be liable for malfunction, damage or wear caused by the incompatibility of Graco equipment with structures, accessories, equipment or materials not supplied by Graco, or the improper design, manufacture, installation, operation or maintenance of structures, accessories, equipment or materials not supplied by Graco.

This warranty is conditioned upon the prepaid return of the equipment claimed to be defective to an authorized Graco distributor for verification of the claimed defect. If the claimed defect is verified, Graco will repair or replace free of charge any defective parts. The equipment will be returned to the original purchaser transportation prepaid. If inspection of the equipment does not disclose any defect in material or workmanship, repairs will be made at a reasonable charge, which charges may include the costs of parts, labor, and transportation.

**THIS WARRANTY IS EXCLUSIVE, AND IS IN LIEU OF ANY OTHER WARRANTIES, EXPRESS OR IMPLIED, INCLUDING BUT NOT LIMITED TO WARRANTY OF MERCHANTABILITY OR WARRANTY OF FITNESS FOR A PARTICULAR PURPOSE.**

Graco's sole obligation and buyer's sole remedy for any breach of warranty shall be as set forth above. The buyer agrees that no other remedy (including, but not limited to, incidental or consequential damages for lost profits, lost sales, injury to person or property, or any other incidental or consequential loss) shall be available. Any action for breach of warranty must be brought within two (2) years of the date of sale.

**GRACO MAKES NO WARRANTY, AND DISCLAIMS ALL IMPLIED WARRANTIES OF MERCHANTABILITY AND FITNESS FOR A PARTICULAR PURPOSE, IN CONNECTION WITH ACCESSORIES, EQUIPMENT, MATERIALS OR COMPONENTS SOLD BUT NOT MANUFACTURED BY GRACO.** These items sold, but not manufactured by Graco (such as electric motors, switches, hose, etc.), are subject to the warranty, if any, of their manufacturer. Graco will provide purchaser with reasonable assistance in making any claim for breach of these warranties.

In no event will Graco be liable for indirect, incidental, special or consequential damages resulting from Graco supplying equipment hereunder, or the furnishing, performance, or use of any products or other goods sold hereto, whether due to a breach of contract, breach of warranty, the negligence of Graco, or otherwise.

## **FOR GRACO CANADA CUSTOMERS**

The Parties acknowledge that they have required that the present document, as well as all documents, notices and legal proceedings entered into, given or instituted pursuant hereto or relating directly or indirectly hereto, be drawn up in English. Les parties reconnaissent avoir convenu que la rédaction du présente document sera en Anglais, ainsi que tous documents, avis et procédures judiciaires exécutés, donnés ou intentés, à la suite de ou en rapport, directement ou indirectement, avec les procédures concernées.

# Graco Information

## Sealant and Adhesive Dispensing Equipment

For the latest information about Graco products, visit [www.graco.com](http://www.graco.com).

For patent information, see [www.graco.com/patents](http://www.graco.com/patents).

**TO PLACE AN ORDER**, contact your Graco distributor, go to [www.graco.com](http://www.graco.com), or call to identify the nearest distributor.

**If calling from the USA:** 1-800-746-1334

**If calling from outside the USA:** 0-1-330-966-3000

*All written and visual data contained in this document reflects the latest product information available at the time of publication. Graco reserves the right to make changes at any time without notice.*

Original instructions. This manual contains English. MM 312759

**Graco Headquarters:** Minneapolis

**International Offices:** Belgium, China, Japan, Korea

**GRACO INC. AND SUBSIDIARIES • P.O. BOX 1441 • MINNEAPOLIS MN 55440-1441 • USA**  
**Copyright 2008, Graco Inc. All Graco manufacturing locations are registered to ISO 9001.**

[www.graco.com](http://www.graco.com)

Revision ZAC, August 2022