



## E-Flo® DC Motor, Three Phase

3A4409F  
EN

Electric drive for low to medium volume paint circulation pumps.  
For professional use only.



### Important Safety Instructions

Read all warnings and instructions in this manual before using the equipment. Save these instructions.

*See page 3 for model part numbers and approvals information.*

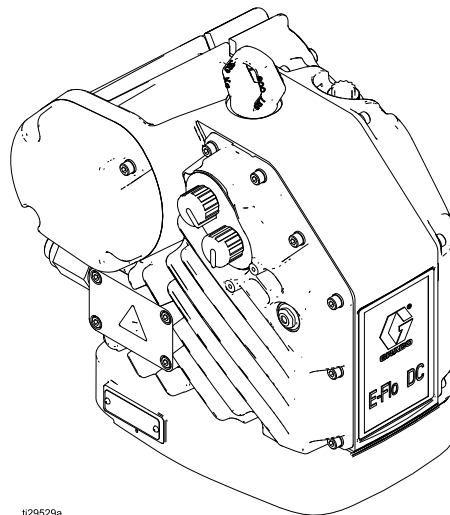

t129529a

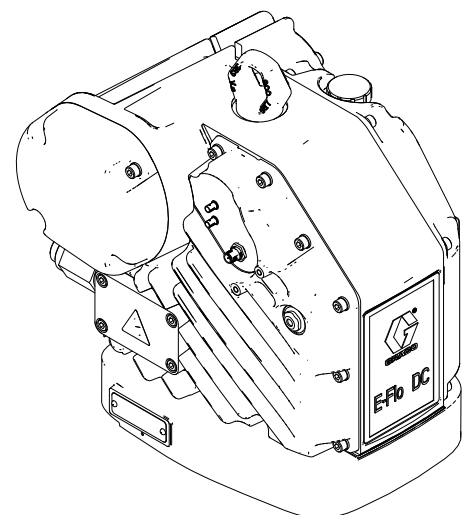

# Contents

Related Manuals .....	2	Pressure Relief Procedure .....	13
Models .....	3	Advanced Motor Operation .....	13
Basic Models .....	3	Basic Motor Operation .....	14
Basic Models with Region-Specific		Maintenance .....	16
Approvals .....	4	Preventive Maintenance Schedule .....	16
Advanced Models .....	5	Change the Oil .....	16
Advanced Models with Region-Specific		Check the Oil Level .....	16
Approvals .....	6	Error Code Troubleshooting .....	17
Warnings .....	7	Accessories .....	18
Installation .....	10	Appendix A - System Control Drawing	
Check the Oil Level Before Using the		24Z541 .....	19
Equipment .....	10	Dimensions and Mounting Holes .....	22
Power Requirements .....	10	E-Flo DC Motor Dimensions .....	22
Connect the Supply Wiring .....	11	Mounting Hole Pattern .....	22
Grounding .....	12	Technical Specifications .....	23
Intrinsically Safe Installation Requirements		California Proposition 65 .....	23
for Advanced Motors .....	12		
Operation .....	13		
Startup .....	13		
Shutdown .....	13		

## Related Manuals

Manual No.	Description
3A4801	E-Flo DC Repair-Parts
3A2527	E-Flo DC Control Module Kit, Instructions-Parts

# Models

## Basic Models

Motor Part No.	Series	Horsepower	Maximum Force, lbf (N)
EM1011	A	1	1400 (6227)
EM1021	A	2	3500 (15570)



Ex db IIA T4 Gb 0°C ≤ Ta ≤ 40°C  
 FM12ATEX0067X  
 FM21UKEX0205X  
 IECEx FMG 12.0028X



APPROVED For Class I, Div. 1, Group D T4.  
 Class 1, Zone 1, AEx db IIA T4 Gb 0°C ≤ Ta ≤ 40°C  
 Ex db IIA T4 Gb 0°C ≤ Ta ≤ 40°C  
 FM17US0033X  
 FM17CA0018X

**Explosion proof. For Class I, Div 1, Group D T4.**  
**Class 1, Zone 1, AEx db IIA T4 Gb, Ex db IIA T4 Gb, 0°C ≤ Ta ≤ 40°C.**  
**Use cables rated 70°C minimum. Conduit seal required within 18 inches for US and Canada.**  
**Utiliser des câbles résistant à 70°C minimum.**  
**Joint de conduite nécessaire à moins de 457 mm (18 po.) pour les États-Unis et le Canada.**

**E-Flo® DC Motor**

	V~	kVA	Hz
	380-480 3Φ		50/60

PART NO.	SERIES NO.	MFG. YR.	SERIAL NO.

Ex db IIA T4 Gb  
 0°C ≤ Ta ≤ 40°C  
 FM12ATEX0067X  
 FM21UKEX0205X  
 IECEx FMG 12.0028X

APPROVED  
 FM17US0033X  
 FM17CA0018X

**GRACO INC.**  
 P.O. Box 1441  
 Minneapolis, MN  
 55440 U.S.A.

17N251g

Figure 1 Basic Motor Identification Label

### List of Standards

- FM 3600:2018
- FM 3615:2018
- FM 3810:2018
- ANSI/ISA 60079-0:2013
- ANSI/UL 60079-1:2015
- CSA-C22.2 No. 0.4:2017
- CSA-C22.2 No. 0.5:2016
- CSA-C22.2 No. 30:R2016
- CAN/CSA-C22.2 No. 60079-0:2015
- CAN/CSA-C22.2 No. 60079-1:2016
- CAN/CSA-C22.2 No. 61010-1:R2017
- EN IEC 60079-0:2018
- EN 60079-1:2014
- IEC 60079-0 (Ed. 7.0)
- IEC 60079-1 (Ed. 7.0)

### Specific Conditions of Use:

1. Consult the manufacturer if dimensional information on the flameproof joint is necessary.
2. Consult the manufacturer for genuine replacement fasteners. M8 x 30 socket-head cap screws of Class 12.9 steel or better with a minimum yield strength of 1100 MPa (160,000 psi) are acceptable alternatives.

### Basic Models with Region-Specific Approvals

Motor Part No.	Series	Horsepower	Maximum Force, lbf (N)
EM1013	A	1	1400 (6227)
EM1023	A	2	3500 (15570)

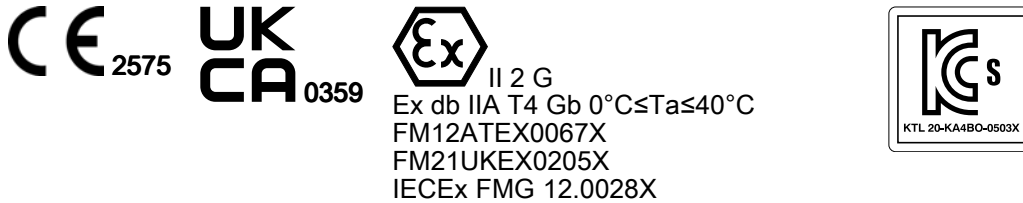

All Models



Model EM1013



Model EM1023

**E-Flo® DC Motor**

PART NO. 部品番号 零件号	SERIES NO. シリーズ NO. 系列号	MFG. YR. MFG. 年月 制造年份	SERIAL NO. シリアル NO. 序列号	VOLTS 電圧(V) 电压	KVA	Hz
						50/60

**Use cables rated 70°C minimum. Read all warnings and instructions in the instruction manual before installation.**

全てのケーブルは70°Cの定格である必要があります。  
 据付する前に取扱説明書内の警告と指示に従って下さい。  
 使用最低额定温度为70°C的电缆。  
 安装前请阅读使用说明书，了解所有的警告和说明内容。

II 2 G  
 Ex d IIA T4 Gb, 2021322301003946  
 Ex db IIA T4 Gb  
 0°C ≤ Ta ≤ 40°C  
 FM12ATEX0067X  
 FM21UKEX0205X  
 IECEx FMG 12.0028X

**GRACO INC.**  
 P.O. Box 1441  
 Minneapolis, MN  
 55440 U.S.A.

17S276f

Figure 2 Basic Motor with Region-Specific Approvals Identification Label

**List of Standards**

- EN IEC 60079-0:2018
- EN 60079-1:2014
- IEC 60079-0 (Ed. 7.0)
- IEC 60079-1 (Ed. 7.0)

**Specific Conditions of Use:**

1. Consult the manufacturer if dimensional information on the flameproof joint is necessary.
2. Consult the manufacturer for genuine replacement fasteners. M8 x 30 socket-head cap screws of Class 12.9 steel or better with a minimum yield strength of 1100 MPa (160,000 psi) are acceptable alternatives.

## Advanced Models

Motor Part No.	Series	Horsepower	Maximum Force, lbf (N)
EM1012	A	1	1400 (6227)
EM1015	A	1	1400 (6227)
EM1022	A	2	3500 (15570)
EM1025	A	2	3500 (15570)



Ex db [ia op is IIA T4 Ga] IIA T4 Gb  
 0°C ≤ Ta ≤ 40°C  
 FM12ATEX0067X  
 FM21UKEX0205X  
 IECEx FMG 12.0028X



APPROVED For Class I, Div. 1, Group D T4.  
 Class 1, Zone 1, AEx db [ia op is IIA Ga] IIA T4 Gb  
 0°C ≤ Ta ≤ 40°C  
 Ex db [ia op is IIA T4 Ga] IIA T4 Gb  
 0°C ≤ Ta ≤ 40°C  
 FM17US0033X  
 FM17CA0018X

**Explosion proof with intrinsically safe [Ex ia] electrical and inherently safe optical connections. For Class I, Div 1, Group D T4.**

**E-Flo® DC Motor**

Use cables rated 70°C minimum. Conduit seal required within 18 inches for US and Canada.  
 Utiliser des câbles résistant à 70 °C minimum.  
 Joint de conduite nécessaire à moins de 457 mm (18 po.) pour les États-Unis et le Canada.

V~	kVA	Hz	Um: 500 VAC
380-480 3Φ		50/60	

PART NO. SERIES NO. MFG. YR. SERIAL NO.

--	--	--	--

Class 1, Zone 1, AEx db [ia op is IIA T4 Ga] IIA T4 Gb,  
 Ex db [ia op is IIA T4 Ga] IIA T4 Gb,  
 0°C ≤ Ta ≤ 40°C.

Ex db [ia op is IIA T4 Ga] IIA T4 Gb  
 0°C ≤ Ta ≤ 40°C  
 FM12ATEX0067X  
 FM21UKEX0205X  
 IECEx FMG 12.0028X

Install per 24Z541.

APPROVED  
 FM17US0033X  
 FM17CA0018X

**GRACO INC.**  
 P.O. Box 1441  
 Minneapolis, MN  
 55440 U.S.A.

17S274F

Figure 3 Advanced Motor Identification Label

### List of Standards

- FM 3600:2018
- FM 3610:2018
- FM 3615:2018
- FM 3810:2018
- ANSI/ISA 60079-0:2013
- ANSI/ISA 60079-11:2014
- ANSI/UL 60079-1:2015
- ANSI/UL 60079-28:2017
- CSA-C22.2 No. 0.4:2017
- CSA-C22.2 No. 0.5:2016
- CSA-C22.2 No. 30:R2016
- CSA-C22.2 No. 60079-28:2016
- CAN/CSA-C22.2 No. 60079-0:2015
- CAN/CSA-C22.2 No. 60079-1:2016
- CAN/CSA-C22.2 No. 60079-11:2014
- CAN/CSA-C22.2 No. 61010-1:R2017
- EN IEC 60079-0:2018
- EN 60079-1:2014
- EN 60079-11:2012
- EN 60079-28:2015
- IEC 60079-0 (Ed. 7.0)
- IEC 60079-1 (Ed. 7.0)
- IEC 60079-11 (Ed. 6.0)
- IEC 60079-28 (Ed. 2.0): 2015

### Specific Conditions of Use:

1. Consult the manufacturer if dimensional information on the flameproof joint is necessary.
2. Consult the manufacturer for genuine replacement fasteners. M8 x 30 socket-head cap screws of Class 12.9 steel or better with a minimum yield strength of 1100 MPa (160,000 psi) are acceptable alternatives.

### Advanced Models with Region-Specific Approvals

Motor Part No.	Series	Horsepower	Maximum Force, lbf (N)
EM1014	A	1	1400 (6227)
EM1016	A	1	1400 (6227)
EM1024	A	2	3500 (15570)
EM1026	A	2	3500 (15570)



Ex db [ia op is IIA T4 Ga] IIA T4 Gb  
 0°C ≤ Ta ≤ 40°C  
 FM12ATEX0067X  
 FM21UKEX0205X  
 IECEx FMG 12.0028X



All Models

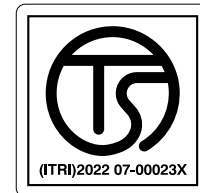

Model EM1014

Model EM1024

**E-Flo® DC Motor**

PART NO.	SERIES NO.	MFG. YR.	SERIAL NO.	VOLTS	Um: 500 VAC	kVA	Hz
部品番号	シリーズ NO.	MFG. 年月	シリアル NO.	電圧(V)			
零件号	系列号	制造年份	序列号	电压			
							50/60

**Install per 24Z541. Use cables rated 70°C minimum. Read all warnings and instructions in the instruction manual before installation.**

24Z541 に従ってインストールする。  
 全てのケーブルは70°Cの定格である必要があります。  
 据付する前に取扱説明書内の警告と指示に従って下さい。

按照24Z541安装。使用最低额定温度为70°C的电缆。  
 安装前请阅读使用说明书，了解所有的警告和说明内容。

Ex d [ia Ga] IIA T4 Gb, 2021322301003965

  	 II 2 (1) G Ex db [ia op is IIA T4 Ga] IIA T4 Gb 0°C ≤ Ta ≤ 40°C FM12ATEX0067X FM21UKEX0205X IECEx FMG 12.0028X	 <b>GRACO INC.</b> P.O. Box 1441 Minneapolis, MN 55440 U.S.A.
----------	---	---

Figure 4 Advanced Motor with Region-Specific Approvals Identification Label

**List of Standards**







- EN IEC 60079-0:2018
- IEC 60079-0 (Ed. 7.0)
- EN 60079-1:2014
- IEC 60079-1 (Ed. 7.0)
- EN 60079-11:2012
- IEC 60079-11 (Ed. 6.0)
- EN 60079-28:2015
- IEC 60079-28 (Ed. 2.0): 2015

**Specific Conditions of Use:**











1. Consult the manufacturer if dimensional information on the flameproof joint is necessary.
2. Consult the manufacturer for genuine replacement fasteners. M8 x 30 socket-head cap screws of Class 12.9 steel or better with a minimum yield strength of 1100 MPa (160,000 psi) are acceptable alternatives.

# Warnings

The following warnings are for the setup, use, grounding, maintenance, and repair of this equipment. The exclamation point symbol alerts you to a general warning and the hazard symbols refer to procedure-specific risks. When these symbols appear in the body of this manual or on warning labels, refer back to these warnings. Product-specific hazard symbols and warnings not covered in this section may appear throughout the body of this manual where applicable.

 <h2 style="margin: 0;">DANGER</h2>	
 	<p><b>SEVERE ELECTRIC SHOCK HAZARD</b></p> <p>This equipment is powered by more than 240V. Contact with this voltage will cause death or serious injury.</p> <ul style="list-style-type: none"> <li>• Turn off and disconnect the power at the main switch before disconnecting any cables and before servicing equipment.</li> <li>• This equipment must be grounded. Connect only to a grounded power source.</li> <li>• All electrical wiring must be done by a qualified electrician and comply with all local codes and regulations.</li> </ul>
 <h2 style="margin: 0;">WARNING</h2>	
   	<p><b>FIRE AND EXPLOSION HAZARD</b></p> <p>Flammable fumes, such as solvent and paint fumes, in work area can ignite or explode. Paint or solvent flowing through the equipment can cause static sparking. To help prevent fire and explosion:</p> <ul style="list-style-type: none"> <li>• Use equipment only in well-ventilated area.</li> <li>• Eliminate all ignition sources; such as pilot lights, cigarettes, portable electric lamps, and plastic drop cloths (potential static sparking).</li> <li>• Ground all equipment in the work area. See <b>Grounding</b> instructions.</li> <li>• Keep work area free of debris, including solvent, rags, and gasoline.</li> <li>• Do not plug or unplug power cords, or turn power or light switches on or off when flammable fumes are present.</li> <li>• Use only grounded hoses.</li> <li>• Hold gun firmly to side of grounded pail when triggering into pail. Do not use pail liners unless they are antistatic or conductive.</li> <li>• <b>Stop operation immediately</b> if static sparking occurs or you feel a shock. Do not use equipment until you identify and correct the problem.</li> <li>• Keep a working fire extinguisher in the work area.</li> </ul>
	<p><b>SPECIAL CONDITIONS FOR SAFE USE</b></p> <ul style="list-style-type: none"> <li>• Consult the manufacturer if dimensional information on the flameproof joints is necessary.</li> <li>• Consult the manufacturer for genuine replacement terminal compartment/wiring entry and enclosure fasteners. M8x30 socket headed cap screws of Class 12.9 steel or better with a minimum yield strength of 1100 MPa (160,000 psi) are acceptable alternatives.</li> </ul>





# WARNING

  	<p><b>INTRINSIC SAFETY</b></p> <p>Intrinsically safe equipment that is installed improperly or connected to non-intrinsically safe equipment will create a hazardous condition and can cause fire, explosion, or electric shock. Follow local regulations and the following safety requirements.</p> <ul style="list-style-type: none"> <li>• Be sure your installation complies with national, state, and local codes for the installation of electrical apparatus in a Class I, Group D, Division 1 Hazardous Location, including all of the local safety fire codes, NFPA 33, NEC 500 and 516, and OSHA 1910.107.</li> <li>• Equipment that comes in contact with the equipment's intrinsically safe terminals must meet the entity parameter requirements specified in Control Drawing 24Z541. See <a href="#">Intrinsically Safe Installation Requirements for Advanced Motors, page 12</a>. This includes safety barriers, DC voltage meters, ohmmeters, cables, and connections. Remove the unit from the hazardous area when troubleshooting.</li> <li>• Do not install any equipment approved only for a non-hazardous location in a hazardous area, as defined in Article 500 of the National Electrical Code (USA) or your local electrical code. See the ID label for the intrinsic safety rating for your equipment.</li> <li>• Ground the motor. Use a 12 gauge minimum ground wire, connected to a true earth ground. See <a href="#">Grounding, page 12</a>.</li> <li>• Do not operate the motor with any cover removed.</li> <li>• Do not substitute system components, as this may impair intrinsic safety.</li> </ul>
	<p><b>BURN HAZARD</b></p> <p>Equipment surfaces and fluid that is heated can become very hot during operation. To avoid severe burns:</p> <ul style="list-style-type: none"> <li>• Do not touch hot fluid or equipment.</li> </ul>
 	<p><b>MOVING PARTS HAZARD</b></p> <p>Moving parts can pinch, cut, or amputate fingers and other body parts.</p> <ul style="list-style-type: none"> <li>• Keep clear of moving parts.</li> <li>• Do not operate equipment with protective guards or covers removed.</li> <li>• Pressurized equipment can start without warning. Before checking, moving, or servicing equipment, follow the <b>Pressure Relief Procedure</b> and disconnect all power sources.</li> </ul>
    	<p><b>SKIN INJECTION HAZARD</b></p> <p>High-pressure fluid from dispensing device, hose leaks, or ruptured components will pierce skin. This may look like just a cut, but it is a serious injury that can result in amputation. <b>Get immediate surgical treatment.</b></p> <ul style="list-style-type: none"> <li>• Engage trigger lock when not dispensing.</li> <li>• Do not point dispensing device at anyone or at any part of the body.</li> <li>• Do not put your hand over the fluid outlet.</li> <li>• Do not stop or deflect leaks with your hand, body, glove, or rag.</li> <li>• Follow the <b>Pressure Relief Procedure</b> when you stop dispensing and before cleaning, checking, or servicing equipment.</li> <li>• Tighten all fluid connections before operating the equipment.</li> <li>• Check hoses and couplings daily. Replace worn or damaged parts immediately.</li> </ul>









# WARNING

 	<p><b>EQUIPMENT MISUSE HAZARD</b></p> <p>Misuse can cause death or serious injury.</p> <ul style="list-style-type: none"> <li>• Do not operate the unit when fatigued or under the influence of drugs or alcohol.</li> <li>• Do not exceed the maximum working pressure or temperature rating of the lowest rated system component. See <b>Technical Specifications</b> in all equipment manuals.</li> <li>• Use fluids and solvents that are compatible with equipment wetted parts. See <b>Technical Specifications</b> in all equipment manuals. Read fluid and solvent manufacturer's warnings. For complete information about your material, request Safety Data Sheets (SDSs) from distributor or retailer.</li> <li>• Do not leave the work area while equipment is energized or under pressure.</li> <li>• Turn off all equipment and follow the <b>Pressure Relief Procedure</b> when equipment is not in use.</li> <li>• Check equipment daily. Repair or replace worn or damaged parts immediately with genuine manufacturer's replacement parts only.</li> <li>• Do not alter or modify equipment. Alterations or modifications may void agency approvals and create safety hazards.</li> <li>• Make sure all equipment is rated and approved for the environment in which you are using it.</li> <li>• Use equipment only for its intended purpose. Call your distributor for information.</li> <li>• Route hoses and cables away from traffic areas, sharp edges, moving parts, and hot surfaces.</li> <li>• Do not kink or over bend hoses or use hoses to pull equipment.</li> <li>• Keep children and animals away from work area.</li> <li>• Comply with all applicable safety regulations.</li> </ul>
	<p><b>TOXIC FLUID OR FUMES HAZARD</b></p> <p>Toxic fluids or fumes can cause serious injury or death if splashed in the eyes or on skin, inhaled, or swallowed.</p> <ul style="list-style-type: none"> <li>• Read Safety Data Sheets (SDSs) to know the specific hazards of the fluids you are using.</li> <li>• Store hazardous fluid in approved containers, and dispose of it according to applicable guidelines.</li> </ul>
	<p><b>PERSONAL PROTECTIVE EQUIPMENT</b></p> <p>Wear appropriate protective equipment when in the work area to help prevent serious injury, including eye injury, hearing loss, inhalation of toxic fumes, and burns. Protective equipment includes but is not limited to:</p> <ul style="list-style-type: none"> <li>• Protective eyewear, and hearing protection.</li> <li>• Respirators, protective clothing, and gloves as recommended by the fluid and solvent manufacturer.</li> </ul>

# Installation

				
<p>Improper wiring may cause electric shock or other serious injury if work is not performed properly.</p> <ul style="list-style-type: none"> <li>• This equipment must be grounded. Connect only to a grounded power source.</li> <li>• All electrical wiring must be done by a qualified electrician and comply with all local codes and regulations.</li> </ul>				

**NOTE:** To install an advanced motor, also see [Intrinsically Safe Installation Requirements for Advanced Motors](#), page 12.

## Check the Oil Level Before Using the Equipment

The motor is pre-filled with oil. Before using the equipment, replace the shipping plug with the vented fill cap (P) that is included with the motor.

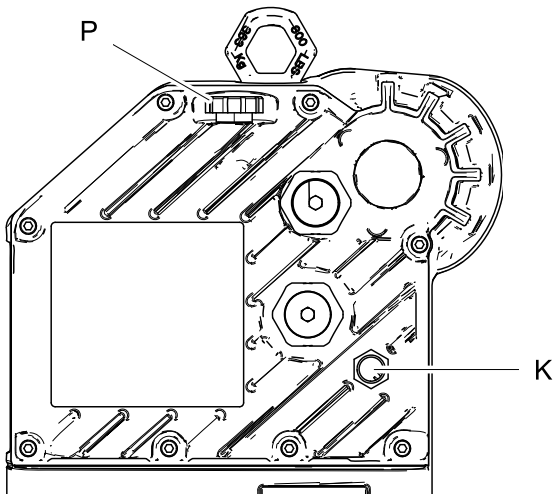

ti18022a

Figure 5 Sightglass and Oil Fill Cap

## Power Requirements

See Table 1 for power requirements. The system requires a dedicated circuit protected with a circuit breaker.

**Table 1 . Power Specifications**

Model*	Voltage	Phase	Hz	kVA
EM101x	380–480 Vac	3	50/60	1.5
EM102x	380–480 Vac	3	50/60	3.0

\* The last digit of the Model No. varies. See the **Models** tables on pages 3–6.

## Hazardous Location Cabling and Conduit Requirements

### Explosion Proof

All electrical wiring in the hazardous location must be encased in Class I, Division I, Group D approved explosion-proof conduit. Follow all National, State, and Local electric codes.

A conduit seal (D) is required within 18 in. (457 mm) of the motor for the US and Canada.

All cables must be rated at 70°C.

### Flame Proof (ATEX and UKEX)

Use appropriate conduit, connectors, and cable glands rated for ATEX II 2 G. Follow all local electric codes.

All cable glands and cables must be rated at 70°C.

## Connect the Supply Wiring

1. Ensure that the disconnect (B) is shut off and locked out.

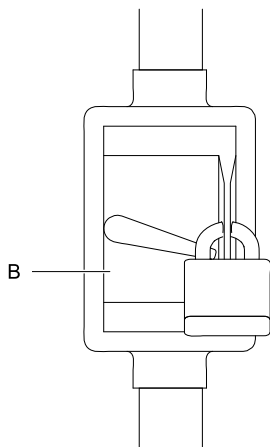

ti20170a

Figure 6 Example of a Locked Out Disconnect

2. Install a start/stop control (C) in the electrical supply line (A), within easy reach of the equipment. The start/stop control must be approved for use in hazardous locations.
3. Open the electrical compartment (S) on the motor.
4. Bring the supply wires into the electrical compartment through the 3/4–14 npt(f) inlet port. Connect the wires to the terminals, as shown. Torque the terminal nuts to 15 in-lb (2 N•m) maximum. **Do not over-torque.**

5. Close the electrical compartment. Torque the cover screws (J) to 15 ft-lb (20 N•m).

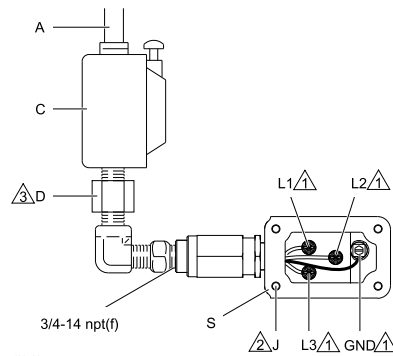





i29533a

Figure 7 Connect the Supply Wires

Notes for Fig. 7	
1	Tighten all terminal nuts to 15 in-lb (2 N•m) maximum. <b>Do not over-torque.</b>
2	Tighten cover screws to 15 ft-lb (20 N•m).
3	A conduit seal (D) is required within 18 in. (457 mm) of the motor for the US and Canada.

## Grounding

				
<p>This equipment must be grounded to reduce the risk of static sparking and electric shock. Electric or static sparking can cause fumes to ignite or explode. Improper grounding can cause electric shock. Grounding provides an escape wire for the electric current.</p>				

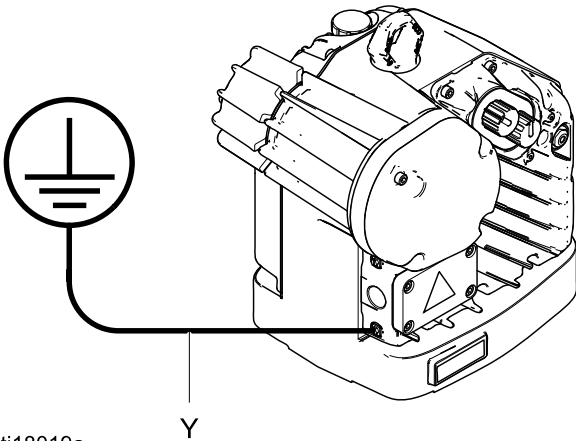

1. Connect the supply ground wire in the electrical compartment as shown in Fig. 7.
2. Connect a ground wire as shown in Fig. 8. Loosen the ground screw and attach a ground wire (Y, Graco part 222011, not supplied). Tighten the ground screw securely. Connect the other end of the ground wire to a true earth ground.



ti18019a

Figure 8 Ground Wire

## Intrinsically Safe Installation Requirements for Advanced Motors

				
<p>Do not substitute or modify system components as this may impair intrinsic safety. For component installation, maintenance, or operation instructions, read the component system manuals. Only install equipment in a hazardous location if the equipment is approved for a hazardous location. See the identification label for the intrinsic safety rating for your model.</p>				

See [Appendix A - System Control Drawing 24Z541, page 19](#), for installation requirements and entity parameters. Follow all installation instructions in your system component manuals.

# Operation

## Startup

1. Unlock the fused safety switch (B) and turn it on. See [Connect the Supply Wiring, page 11](#).
2. Press the start pushbutton (C).
3. Check that the power indicator (L) is lit (steady on).
4. See [Advanced Motor Operation, page 13](#) or [Basic Motor Operation, page 14](#) for further instructions.

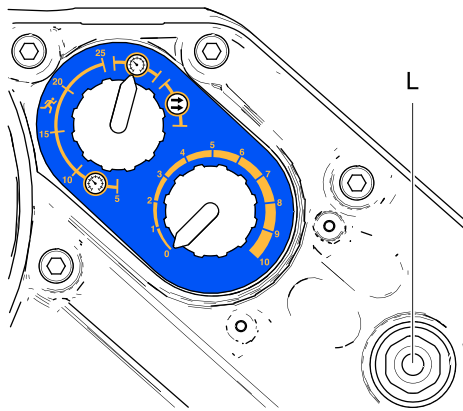

ti20259a

Figure 9 Power Indicator

## Shutdown

Follow the [Pressure Relief Procedure, page 13](#).

## Pressure Relief Procedure



Follow the Pressure Relief Procedure whenever you see this symbol.

This equipment stays pressurized until pressure is manually relieved. To help prevent serious injury from pressurized fluid, such as skin injection, splashing fluid and moving parts, follow the Pressure Relief Procedure when you stop spraying and before cleaning, checking, or servicing the equipment.

1. Disengage the start/stop control (C). See [Connect the Supply Wiring, page 11](#).
2. Shut off and lock out the fused safety switch (B).
3. Relieve all fluid pressure as explained in your separate pump manual.

## Advanced Motor Operation

The Advanced E-Flo DC motors require installation of the 17V232 or 17V233 Control Module Accessory Kit to provide the interface for users to enter selections and view information related to setup and operation. See the Control Module Accessory Kit manual 3A2527 for installation and operation information.

### NOTICE

To prevent damage to the softkey buttons, do not press the buttons with sharp objects such as pens, plastic cards, or fingernails.

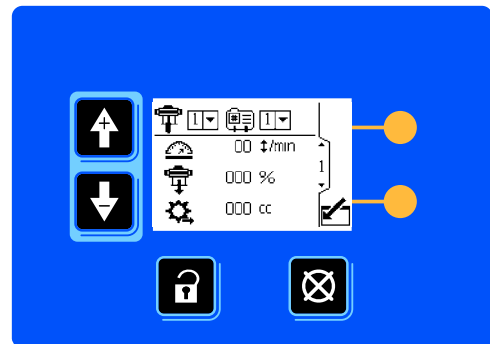



ti19866a

Figure 10 Control Module Accessory

## Basic Motor Operation

The basic motor has three operating modes:

- Pressure Mode 
- Pressure Mode with Integrated Runaway Protection 
- Flow Mode 

**NOTE:** Before changing from one mode to another, turn the Control Knob (N) fully counterclockwise to 0.

### Pressure Mode

When in pressure mode, the motor will adjust the speed to maintain a constant fluid pressure.

1. Turn the Control Knob (N) fully counterclockwise to 0.
2. Pull the Mode Select switch (M) out to set. Turn the switch to Pressure . Push the switch in to lock.
3. Pull the Control Knob (N) out to set. Turn the knob clockwise to increase the pressure, or counterclockwise to decrease the pressure. Push the knob in to lock.

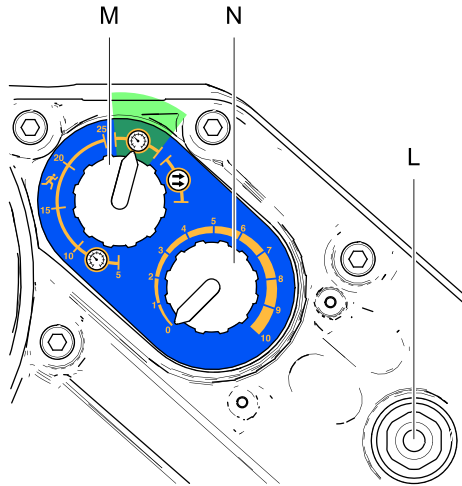

ti20171a

Figure 11 Pressure Mode

### Pressure Mode with Integrated Runaway Protection

In pressure mode with integrated runaway protection, the motor will adjust the speed to maintain a constant fluid pressure, but will shut down if it exceeds a user-set speed.

1. Turn the Control Knob (N) fully counterclockwise to 0.
2. Pull the Mode Select switch (M) out to set. In the Runaway  range, turn the switch to the desired shutdown speed in cycles per minute (5, 10, 15, 20, or 25). Push the switch in to lock.
3. Pull the Control Knob (N) out to set. Turn the knob clockwise to increase the pressure, or counterclockwise to decrease the pressure. Push the knob in to lock.

**NOTE:** The motor will shut down if the selected speed is exceeded for 5 cycles. To reset, turn the Control Knob (N) fully counterclockwise to 0, then turn to the desired pressure.

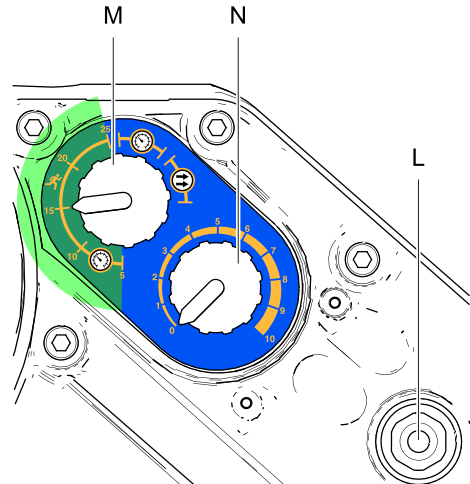

ti20172a

Figure 12 Pressure Mode with Integrated Runaway Protection

## Flow Mode

When in flow mode, the motor will maintain a constant speed regardless of the fluid pressure, up to the pump's maximum working pressure. See [Technical Specifications, page 23](#).

1. Turn the Control Knob (N) fully counterclockwise to 0.
2. Pull the Mode Select switch (M) out to set. Turn the switch to Flow . Push the switch in to lock.
3. The amount of flow is determined by the cycle rate set with the Control Knob (N). The knob's scale (0–10) corresponds to a cycle adjustment range of 0-30 cycles per minute. Turn the Control Knob (N) clockwise to increase the cycle rate (flow), or counterclockwise to decrease the cycle rate (flow).

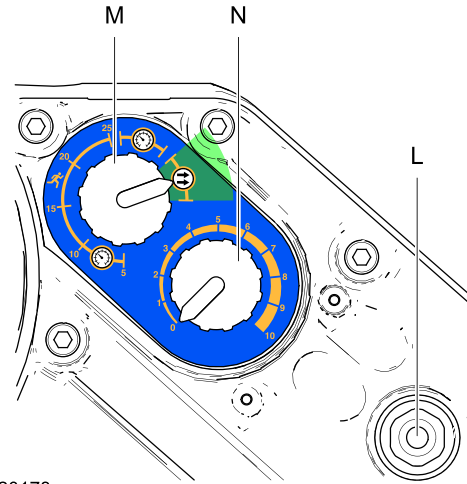

ti20173a

Figure 13 Flow Mode

# Maintenance

## Preventive Maintenance Schedule

The operating conditions of your particular system determine how often maintenance is required. Establish a preventive maintenance schedule by recording when and what kind of maintenance is needed, and then determine a regular schedule for checking your system.

## Change the Oil

**NOTE:** Change the oil after a break-in period of 200,000–300,000 cycles. After the break-in period, change the oil once a year. Order two Part No. 16W645 ISO 220 silicone-free synthetic gear oil.

1. Place a minimum two-quart (1.9 liter) container under the oil drain port. Remove the oil drain plug (25). Allow all oil to drain from the motor.
2. Reinstall the oil drain plug (25). Torque to 25–30 ft-lb (34–40 N•m).
3. Open the fill cap (P) and add Graco Part No. 16W645 ISO 220 silicone-free synthetic gear oil. Check the oil level in the sight glass (K). Fill until the oil level is near the halfway point of the sight glass. The oil capacity is approximately 1.5 quarts (1.4 liters). **Do not overfill.**
4. Reinstall the fill cap.

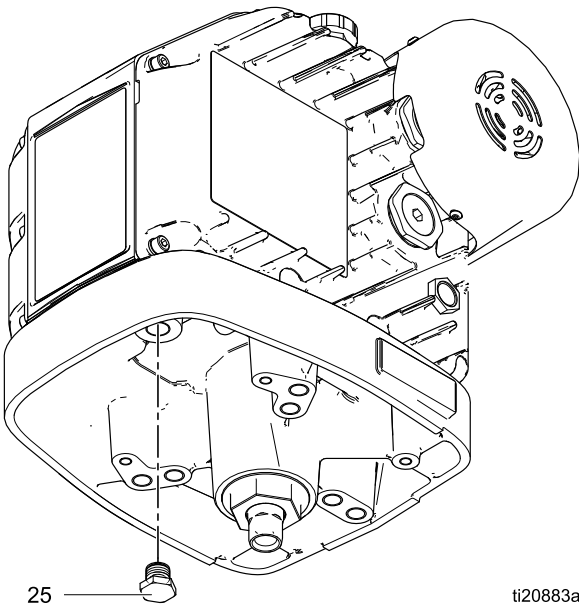
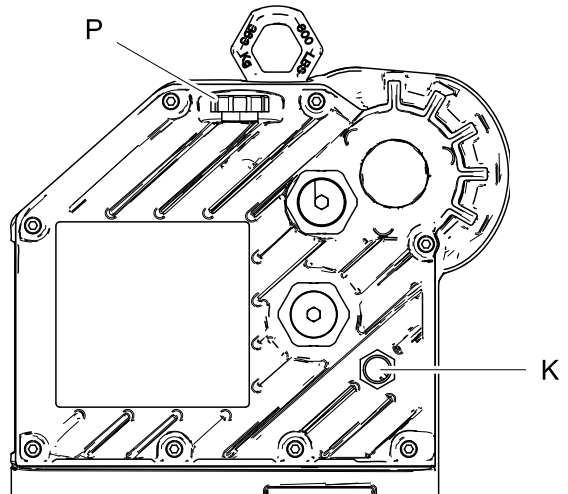

Figure 14 Oil Drain Plug

ti20883a

## Check the Oil Level

Check the oil level in the sight glass (K). The oil level should be near the halfway point of the sight glass when the unit is not running. If low, open the fill cap (P) and add Graco Part No. 16W645 ISO 220 silicone-free synthetic gear oil as required. **Do not overfill.**



ti19679b



Figure 15 Sightglass and Oil Fill Cap



# Error Code Troubleshooting

**NOTE:** The blink code is displayed using the power indicator on the motor. The blink code given below indicates the sequence. For example, blink code 2–6

indicates 2 blinks, then 6 blinks. The sequence then repeats.

Blink Code	Description
1	Flow exceeds maximum target; also indicates pump runaway condition exists.
2	Brown out; voltage supplied to motor is too low.
4	An internal control board hardware failure is detected.
5	Over temperature.
6	The Mode Select knob is set between Pressure  and Flow  . Set knob to the desired mode.
2–4	Temporary circuit board communication error.
2–6	AC power is lost.
3–5	Internal thermistor disconnected.
3–4	Software versions do not match.
3–6	Circuit board communication failure.
4–5	Internal software error.
5–6	Calibration of the encoder and stroke range is in progress.

## Accessories

Motor Part No.	Description	Kits	Kit Description
Models EM10X2 and EM10X5	E-Flo DC Advanced Motors	17V232	Control Module, for Advanced Motors; see manual 3A2527.
Models EM10X4 and EM10X6	E-Flo DC Advanced Motors	17V233	Control Module, for Advanced Motors; see manual 3A2527.
Models EM10X2, EM10X4, EM10X5, and EM10X6	E-Flo DC Advanced Motors	16P911	CAN Cable, 3 ft (1 m)
		16P912	CAN Cable, 25 ft (8 m)
All motors in this manual	Connection kits, to mount an E-Flo DC Motor to an existing pump lower. Kits include tie rods, tie rod nuts, adapter, and coupler.	288203	For 3000 and 4000 cc 4-Ball Lowers
		288204	For Dura-Flo 1800 and 2400 Lowers
		288205	For Dura-Flo 600, 750, 900, and 1200 Lowers
		288206	For Dura-Flo 1000 Lowers
		288207	For Xtreme 145, 180, 220, 250, and 290 Lowers
		288209	For 750, 1000, 1500, and 2000 cc 4-Ball Lowers with Enclosed or Open Wet Cup
		288860	For Xtreme 85 and 115 Lowers
		17K525	For 750, 1000, 1500, and 2000 cc Sealed 4-Ball Lowers
All motors in this manual	Mounting kits	255143	Wall Mounting Kit
		253692	Floor Stand

# Appendix A - System Control Drawing 24Z541

**NOTES FOR FIG. 16 AND 17:**

1. The non-intrinsically safe terminals (power rail) must not be connected to any device which uses or generates more than  $U_m = 500 V_{rms}$  or DC unless it has been determined that the voltage has been adequately isolated.
2. Do not remove any cover until power has been removed.
3. Installation in the U.S.A. must be in accordance with ANSI/ISA RP12.06.01, installation of intrinsically safe systems for hazardous (classified) locations, and the National Electrical Code (ANSI/NFPA 70).
4. Installation in Canada must be in accordance with the Canadian Electrical Code, CSA C22.1, Part 1, Appendix F.
5. For ATEX and UKEX, install according to EN 60079-14 and applicable local and national codes.
6. For IECEx, install according to IEC 60079-14 and applicable local and national codes.
7. For installation, maintenance, or operation instructions, see the instruction manual.

**WARNING:** Substitution of components may impair intrinsic safety.

**ADVERTISSEMENT:** La substitution de composants peut compromettre la securite intrinseque.

8.  Graco CAN cable part numbers 16P911, 16P912.

9. The output entity parameters given for pins 1 and 4 in port 3 are the total current and power available to both pins added together. The current on pin 1 and pin 4 added together will not exceed the listed  $I_o$ , and the power output from pin 1 and pin 4 added together will not exceed the listed  $P_o$ .
10. The intrinsically safe electrical outputs provided by the associated apparatus are not isolated from earth.
11. The control drawing of the intrinsically safe apparatus must specify that the intrinsically safe apparatus provides internal isolation between CAN power and CAN Hi/CAN Lo circuits and connections.
12. The specified  $C_o$  and  $L_o$  values already include consideration of the effects of capacitance and inductance in combination.

**Table 2 . Calculation Procedures**

Divisions	Zones
$V_{oc} \leq V_{max}$	$U_o \leq U_i$
$I_{sc} \leq I_{max}$	$I_o \leq I_i$
$P_o \leq P_i$	$P_o \leq P_i$
$C_a \geq C_i + C_{cable}$	$C_o \geq C_i + C_{cable}$
$L_a \geq L_i + L_{cable}$	$L_o \geq L_i + L_{cable}$
$L_a / R_a \geq L_i / R_i$	$L_o / R_o \geq L_i / R_i$

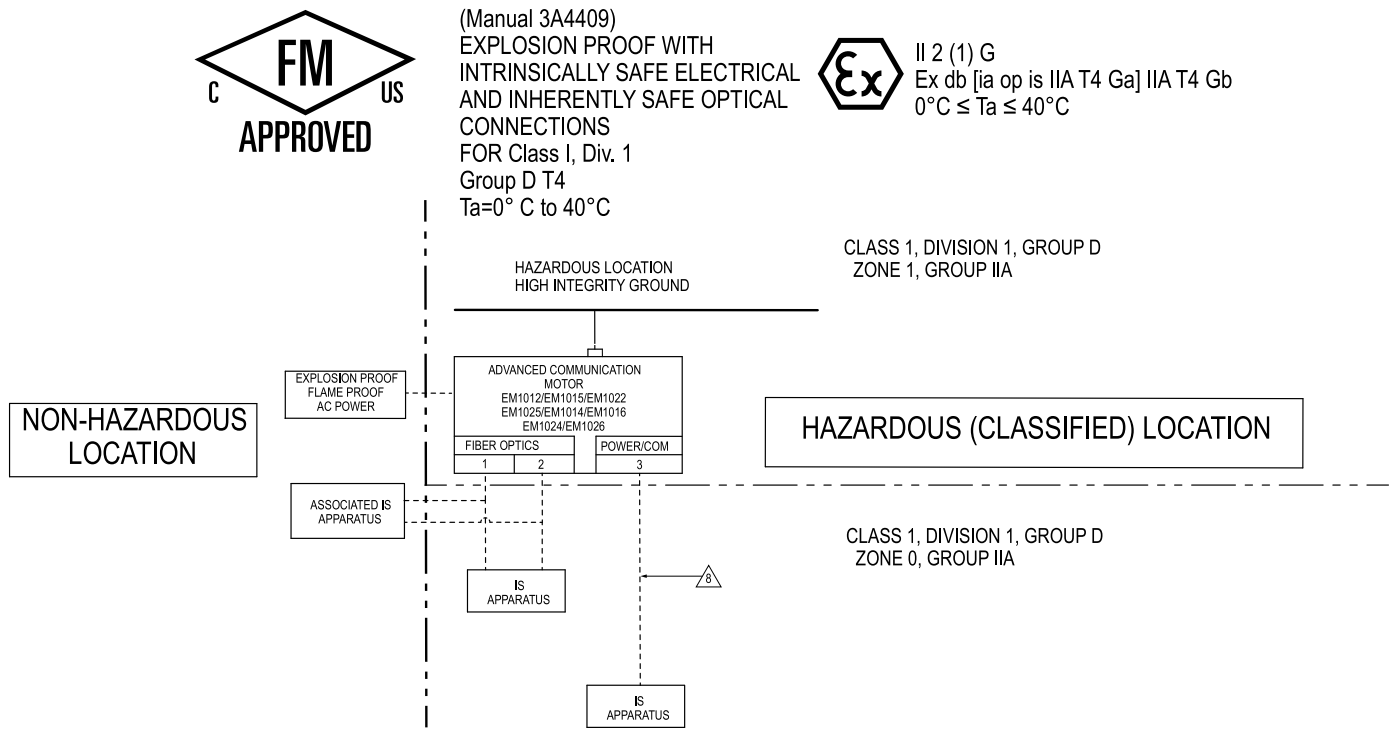

Figure 16 System Control Drawing 24Z541, Sheet 1

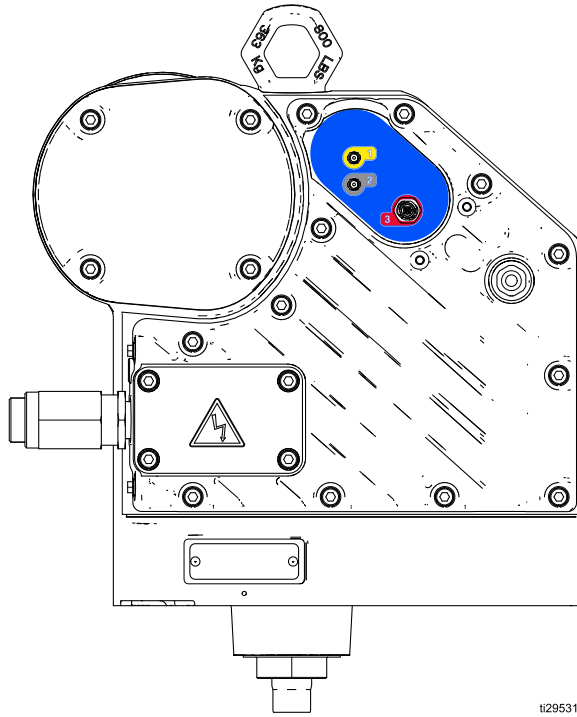
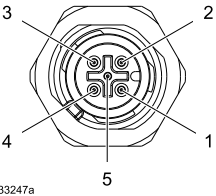

Figure 17 System Control Drawing 24Z541, Sheet 2

Table 3 . Port 3: Power Barrier Output Parameters

Port 3: Male M12 5 Pin "A" Key 	CAN Data High/Low — Output Barriers							
	Pin	Units	Uo	Io	Po	Lo	Co	Lo/Ro
			Voc	Isc	Pt	La	Ca	La/Ra
			V	mA	mW	μH	μF	μH/Ohm
1	CAN Data Low	4.94	63.3	79	709	999	3639	
2	Power	17.85	460	2893	116	2.5	98	
3	IS Ground Return	—	—	—	—	—	—	
4	CAN Data High	4.94	63.3	79	709	999	3639	
5	Shield	—	—	—	—	—	—	

# Dimensions and Mounting Holes

## E-Flo DC Motor Dimensions

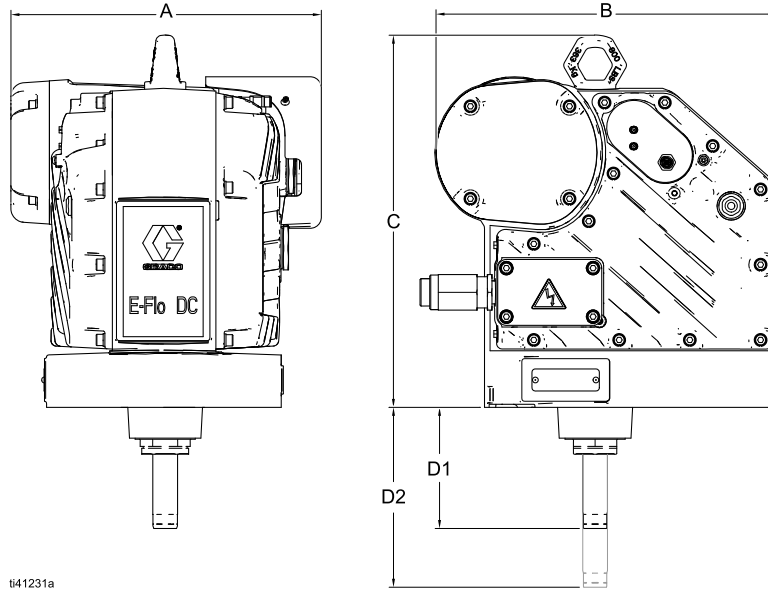

ti41231a

A	B	C	D1	D2
14.07 in. (35.74 cm)	15.54 in. (39.47 cm)	16.79 in. (42.65 cm)	5.44 in. (13.82 cm)	8.18 in. (20.78 cm)

## Mounting Hole Pattern

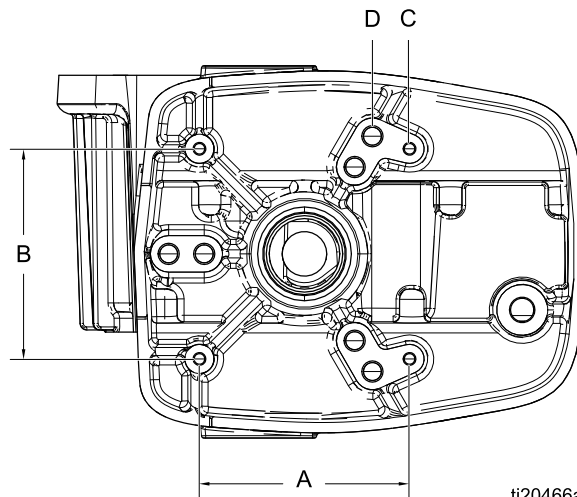

ti20466a

A	B	C	D
6.186 in. (157 mm)	6.186 in. (157 mm)	Four 3/8–16 Mounting Holes	Six 5/8–11 Tie Rod Holes: <ul style="list-style-type: none"> <li>8 in. (203 mm) x 120° bolt circle</li> </ul> OR <ul style="list-style-type: none"> <li>5.9 in. (150 mm) x 120° bolt circle</li> </ul>

# Technical Specifications

E-Flo DC Motors	U.S.	Metric
<b>Input voltage/Power:</b>		
Models EM101x	380–480 VAC three phase, 50/60 Hz, 1.5 kVA	
Models EM102x	380–480 VAC three phase, 50/60 Hz, 3.0 kVA	
<b>Maximum potential fluid pressure:</b>		
Models EM101x	218000/v (volume of lower in cc) = psi	14500/v (volume of lower in cc) = bar
Models EM102x	500000/v (volume of lower in cc) = psi	34500/v (volume of lower in cc) = bar
Maximum continuous cycle rate	20 cpm	
<b>Maximum force:</b>		
Models EM101x	1400 lbf	6227 N
Models EM102x	3500 lbf	15570 N
Power inlet port size	3/4–14 npt(f)	
Ambient temperature range	32–104°F	0–40°C
Sound data	Less than 70 dB(A)	
Oil capacity	1.5 quarts	1.4 liters
Oil specification	Graco Part No. 16W645 ISO 220 silicone-free high-pressure synthetic gear oil	
Weight	99 lb	45 kg

## California Proposition 65

### CALIFORNIA RESIDENTS

 **WARNING:** Cancer and reproductive harm — [www.P65warnings.ca.gov](http://www.P65warnings.ca.gov).

# Graco Standard Warranty

Graco warrants all equipment referenced in this document which is manufactured by Graco and bearing its name to be free from defects in material and workmanship on the date of sale to the original purchaser for use. With the exception of any special, extended, or limited warranty published by Graco, Graco will, for a period of twelve months from the date of sale, repair or replace any part of the equipment determined by Graco to be defective. This warranty applies only when the equipment is installed, operated and maintained in accordance with Graco's written recommendations.

This warranty does not cover, and Graco shall not be liable for general wear and tear, or any malfunction, damage or wear caused by faulty installation, misapplication, abrasion, corrosion, inadequate or improper maintenance, negligence, accident, tampering, or substitution of non-Graco component parts. Nor shall Graco be liable for malfunction, damage or wear caused by the incompatibility of Graco equipment with structures, accessories, equipment or materials not supplied by Graco, or the improper design, manufacture, installation, operation or maintenance of structures, accessories, equipment or materials not supplied by Graco.

This warranty is conditioned upon the prepaid return of the equipment claimed to be defective to an authorized Graco distributor for verification of the claimed defect. If the claimed defect is verified, Graco will repair or replace free of charge any defective parts. The equipment will be returned to the original purchaser transportation prepaid. If inspection of the equipment does not disclose any defect in material or workmanship, repairs will be made at a reasonable charge, which charges may include the costs of parts, labor, and transportation.

**THIS WARRANTY IS EXCLUSIVE, AND IS IN LIEU OF ANY OTHER WARRANTIES, EXPRESS OR IMPLIED, INCLUDING BUT NOT LIMITED TO WARRANTY OF MERCHANTABILITY OR WARRANTY OF FITNESS FOR A PARTICULAR PURPOSE.**

Graco's sole obligation and buyer's sole remedy for any breach of warranty shall be as set forth above. The buyer agrees that no other remedy (including, but not limited to, incidental or consequential damages for lost profits, lost sales, injury to person or property, or any other incidental or consequential loss) shall be available. Any action for breach of warranty must be brought within two (2) years of the date of sale.

**GRACO MAKES NO WARRANTY, AND DISCLAIMS ALL IMPLIED WARRANTIES OF MERCHANTABILITY AND FITNESS FOR A PARTICULAR PURPOSE, IN CONNECTION WITH ACCESSORIES, EQUIPMENT, MATERIALS OR COMPONENTS SOLD BUT NOT MANUFACTURED BY GRACO.** These items sold, but not manufactured by Graco (such as electric motors, switches, hose, etc.), are subject to the warranty, if any, of their manufacturer. Graco will provide purchaser with reasonable assistance in making any claim for breach of these warranties.

In no event will Graco be liable for indirect, incidental, special or consequential damages resulting from Graco supplying equipment hereunder, or the furnishing, performance, or use of any products or other goods sold hereto, whether due to a breach of contract, breach of warranty, the negligence of Graco, or otherwise.

## FOR GRACO CANADA CUSTOMERS

The Parties acknowledge that they have required that the present document, as well as all documents, notices and legal proceedings entered into, given or instituted pursuant hereto or relating directly or indirectly hereto, be drawn up in English. Les parties reconnaissent avoir convenu que la rédaction du présente document sera en Anglais, ainsi que tous documents, avis et procédures judiciaires exécutés, donnés ou intentés, à la suite de ou en rapport, directement ou indirectement, avec les procédures concernées.

## Graco Information

For the latest information about Graco products, visit [www.graco.com](http://www.graco.com). For patent information, see [www.graco.com/patents](http://www.graco.com/patents).

**To place an order**, contact your Graco Distributor or call to identify the nearest distributor.

**Phone:** 612-623-6921 **or Toll Free:** 1-800-328-0211 **Fax:** 612-378-3505

All written and visual data contained in this document reflects the latest product information available at the time of publication.

Graco reserves the right to make changes at any time without notice.

Original Instructions. This manual contains English, MM 3A4409

**Graco Headquarters:** Minneapolis

**International Offices:** Belgium, China, Japan, Korea

**GRACO INC. AND SUBSIDIARIES • P.O. BOX 1441 • MINNEAPOLIS, MN 55440-1441 • USA**  
**Copyright 2018, Graco Inc. All Graco manufacturing locations are registered to ISO 9001.**

[www.graco.com](http://www.graco.com)  
Revision F, October 2022