

## SaniForce® Drum Unloader (SDU)

3A5402N  
EN

For use with hygienic bulk supply of medium to high viscosity product. For professional use only. Only select models are approved for use in explosive atmospheres or hazardous locations. See Configuration Matrix on page 6 for more information.



### Important Safety Instructions

Read all warnings and instructions in this and other system manuals.  
Save all instructions.

*Maximum Working Air Pressure: 100  
psi (0.69 MPa, 6.9 bar)  
Maximum Working Fluid Pressure: See  
Technical Data table.*

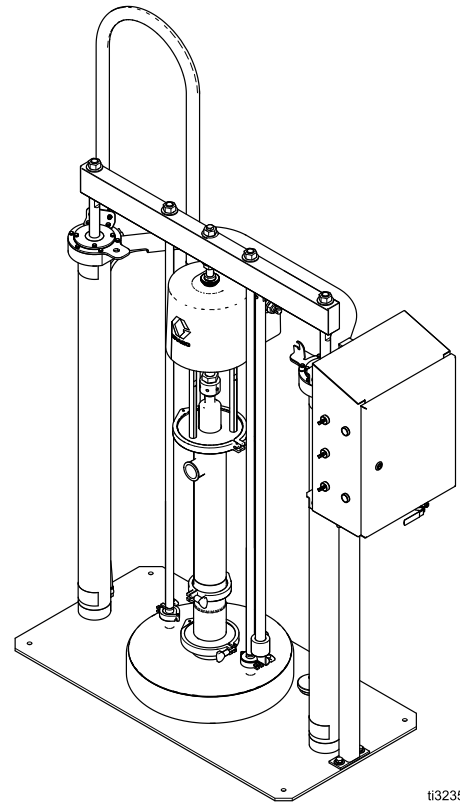

ti32355b

# Contents



Related Manuals .....	2	Maintenance .....	23
Warnings .....	3	Lubrication.....	23
Configuration Matrix.....	6	Cleaning the Ram Plate.....	23
Installation.....	8	Cleaning the Pump Lower .....	24
General Information .....	8	Flushing and Storage .....	24
Choosing a Location for the SDU .....	8	Electro-pneumatic Control Panel Display	
Unpacking the SDU.....	8	Screens .....	25
Control Panel (Exposed).....	10	Startup Screen.....	27
Control Panel (Enclosed Pneumatic) .....	11	Automatic Screen.....	28
Control Panel (Electro-Pneumatic) .....	12	Manual Screen .....	31
Air Line Accessories.....	13	Recipe Screens .....	33
Grounding .....	13	Event Log.....	41
AC Power.....	14	Job Log.....	45
Fluid Outlet Line.....	14	System Configuration Screen .....	47
Manual Ram Lock.....	15	Feedback Control Screen .....	49
Install a Ram Plate Inflatable Seal.....	15	Network.....	52
Remove a Ram Plate Inflatable Seal .....	16	Ethernet/IP .....	53
Adjust Drum Stops .....	17	About .....	59
System Setup (Pneumatic Control).....	17	I/O Status Screen.....	60
System Setup (Electro-pneumatic Control).....	17	Import and Export with USB .....	61
Operation.....	18	Settings Parameters.....	61
Pressure Relief Procedure.....	18	Dimensions .....	65
Clean the Pump Before First Use.....	18	Schematic (exposed control) .....	66
Start and Adjust the Ram.....	19	Schematic (enclosed control).....	67
Start and Adjust the Pump.....	20	Schematic (electo-pneumatic control) .....	68
Change the Drum.....	22	Kits and Accessories.....	73
Emergency Stop .....	22	Technical Data .....	75
Pump Shutdown .....	22		







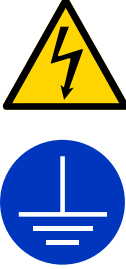

## Related Manuals







Manual Number	Title
3A5798	SaniForce 5:1 Sanitary Pumps, Instructions and Parts
3A5564	SaniForce 6:1 Sanitary Pumps, Instructions and Parts
3A5799	SaniForce 12:1 Sanitary Pumps, Instructions and Parts
3A6781	SaniForce 1590 High Sanitation Diaphragm Pump, Repair and Parts
3A6782	SaniForce High Sanitation Diaphragm Pumps, Models 2150, 3150, 4150, Repair and Parts
3A5800	SaniForce Air Controls, Exposed pneumatic control, Instructions and Parts
3A6101	Enclosed Manual Controls, Repair/Parts
3A6102	Electro-pneumatic Controls, Instructions-Parts
3A5404	SaniForce Drum Unloader (SDU) System, Repair/Parts

# Warnings

The following warnings are for the setup, use, grounding, maintenance, and repair of this equipment. The exclamation point symbol alerts you to a general warning and the hazard symbols refer to procedure-specific risks. When these symbols appear in the body of this manual or on warning labels, refer back to these Warnings. Product-specific hazard symbols and warnings not covered in this section may appear throughout the body of this manual where applicable.

 <h1 style="margin: 0;">WARNING</h1>	
	<p><b>ELECTRIC SHOCK HAZARD</b></p> <p>This equipment must be grounded. Improper grounding, setup, or usage of the system can cause electric shock.</p> <ul style="list-style-type: none"> <li>• Turn off and disconnect power at main switch before disconnecting any cables and before servicing or installing equipment.</li> <li>• Connect only to grounded power source.</li> <li>• All electrical wiring must be done by a qualified electrician and comply with all local codes and regulations.</li> </ul>
	<p><b>FIRE AND EXPLOSION HAZARD</b></p> <p>Flammable fumes, such as solvent and paint fumes, in <b>work area</b> can ignite or explode. Paint or solvent flowing through the equipment can cause static sparking. To help prevent fire and explosion:</p> <ul style="list-style-type: none"> <li>• Use equipment only in well ventilated area.</li> <li>• Eliminate all ignition sources; such as pilot lights, cigarettes, portable electric lamps, and plastic drop cloths (potential static sparking).</li> <li>• Ground all equipment in the work area. See <b>Grounding</b> instructions.</li> <li>• Keep work area free of debris, including solvent, rags and gasoline.</li> <li>• Do not plug or unplug power cords, or turn power or light switches on or off when flammable fumes are present.</li> <li>• Use only grounded hoses.</li> <li>• <b>Stop operation immediately</b> if static sparking occurs or you feel a shock. Do not use equipment until you identify and correct the problem.</li> <li>• Keep a working fire extinguisher in the work area.</li> </ul> <p>Static charge may build up on plastic parts during cleaning and could discharge and ignite flammable vapors. To help prevent fire and explosion:</p> <ul style="list-style-type: none"> <li>• Clean plastic parts only in well ventilated area.</li> <li>• Do not clean with a dry cloth.</li> </ul>

 <b>WARNING</b>	
  	<p><b>MOVING PARTS HAZARD</b></p> <p>Moving parts can pinch or amputate fingers and other body parts.</p> <ul style="list-style-type: none"><li>• Keep clear of moving parts.</li><li>• Do not operate equipment with protective guards or covers removed.</li><li>• Pressurized equipment can start without warning. Before checking, moving, or servicing equipment, follow the <b>Pressure Relief Procedure</b> and disconnect all power sources.</li></ul>
    	<p><b>SKIN INJECTION HAZARD</b></p> <p>High-pressure fluid from dispensing device, hose leaks, or ruptured components will pierce skin. This may look like just a cut, but it is a serious injury that can result in amputation. <b>Get immediate surgical treatment.</b></p> <ul style="list-style-type: none"><li>• Do not point dispensing device at anyone or at any part of the body.</li><li>• Do not put your hand over the fluid outlet.</li><li>• Do not stop or deflect leaks with your hand, body, glove, or rag.</li><li>• Follow the <b>Pressure Relief Procedure</b> when you stop dispensing and before cleaning, checking, or servicing equipment.</li><li>• Tighten all fluid connections before operating the equipment.</li><li>• Check hoses and couplings daily. Replace worn or damaged parts immediately.</li></ul>

 <h1 style="margin: 0;">WARNING</h1>	
 	<p><b>EQUIPMENT MISUSE HAZARD</b></p> <p>Misuse can cause death or serious injury.</p> <ul style="list-style-type: none"> <li>• Do not operate the unit when fatigued or under the influence of drugs or alcohol.</li> <li>• Do not exceed the maximum working pressure or temperature rating of the lowest rated system component. See <b>Technical Data</b> in all equipment manuals.</li> <li>• Use fluids and solvents that are compatible with equipment wetted parts. See <b>Technical Data</b> in all equipment manuals. Read fluid and solvent manufacturer's warnings. For complete information about your material, request Safety Data Sheet (SDS) from distributor or retailer.</li> <li>• Turn off all equipment and follow the <b>Pressure Relief Procedure</b> when equipment is not in use.</li> <li>• Check equipment daily. Repair or replace worn or damaged parts immediately with genuine manufacturer's replacement parts only.</li> <li>• Do not alter or modify equipment. Alterations or modifications may void agency approvals and create safety hazards.</li> <li>• Make sure all equipment is rated and approved for the environment in which you are using it.</li> <li>• Use equipment only for its intended purpose. Call your distributor for information.</li> <li>• Route hoses and cables away from traffic areas, sharp edges, moving parts, and hot surfaces.</li> <li>• Do not kink or over bend hoses or use hoses to pull equipment.</li> <li>• Keep children and animals away from work area.</li> <li>• Comply with all applicable safety regulations.</li> </ul>
	<p><b>TOXIC FLUID OR FUMES HAZARD</b></p> <p>Toxic fluids or fumes can cause serious injury or death if splashed in the eyes or on skin, inhaled, or swallowed.</p> <ul style="list-style-type: none"> <li>• Read Safety Data Sheets (SDSs) to know the specific hazards of the fluids you are using.</li> <li>• Store hazardous fluid in approved containers, and dispose of it according to applicable guidelines.</li> </ul>
	<p><b>SPLATTER HAZARD</b></p> <p>Hot or toxic fluid can cause serious injury if splashed in the eyes or on skin. During blow off of ram plate, splatter may occur.</p> <ul style="list-style-type: none"> <li>• Use minimum air pressure when removing ram plate from container.</li> </ul>
	<p><b>PERSONAL PROTECTIVE EQUIPMENT</b></p> <p>Wear appropriate protective equipment when in the work area to help prevent serious injury, including eye injury, hearing loss, inhalation of toxic fumes, and burns. Protective equipment includes but is not limited to:</p> <ul style="list-style-type: none"> <li>• Protective eyewear, and hearing protection.</li> <li>• Respirators, protective clothing, and gloves as recommended by the fluid and solvent manufacturer.</li> </ul>

# Configuration Matrix

Check the identification plate (ID) for the Configuration Number of your pump. Use the following matrix to define the components of your system.

Sample Configuration Number: **SDU A01AAA1AA0C21**

<b>SDU</b>	<b>A</b>	<b>01</b>	<b>A</b>	<b>A</b>	<b>A</b>	<b>1</b>	<b>AA</b>	<b>0</b>	<b>C21</b>
Sanitary Drum Unloader	Frame	Pump	Ram Plate	Seal Style	Seal Material	Controls	Accessories	Wash Bin	Certification

**NOTE:** Some combinations are not possible. Please check with your local supplier.

Sanitary Drum Unloader	Frame		Pump		Ram Plate		Seal Style	
<b>SDU</b>	<b>A</b>	Stainless Steel	<b>01</b>	5:1 Double Ball	<b>A</b>	20" Inflatable Seal for use with 21.5" to 23.25" Drums	<b>A</b>	Inflatable
	<b>B</b>	Carbon Steel	<b>02</b>	5:1 Priming Piston	<b>B</b>	22.25" Wiper Seal for use with 21.5" Drum	<b>B</b>	Static
			<b>03</b>	6:1 Double Ball	<b>D</b>	23.25" Wiper Seal for use with 22.5" Drum		
			<b>04</b>	6:1 Priming Piston				
			<b>05</b>	12:1 Priming Piston				
			<b>06</b>	1590HS-P.SSFKEO‡				
			<b>07</b>	1590HS-P.SSPFPO‡				
			<b>08</b>	1590HS-P.SSPTPS‡				
			<b>09</b>	1590HS-P.SSSPSP‡				
			<b>11</b>	2150HS-P.SSFKEO‡				
			<b>12</b>	2150HS-P.SSPTPO‡				
			<b>13</b>	2150HS-P.SSPTPS‡				
			<b>14</b>	2150HS-P.SSSPSP‡				
			<b>16</b>	3150HS-P.FL—EO‡				
			<b>17</b>	3150HS-P.FL—PO‡				
			<b>18</b>	3150HS-P.FL—PS‡				
			<b>19</b>	3150HS-P.FL—SP‡				
			<b>21</b>	6:1 Double Ball, Stubby				

‡ Diaphragm pump, identified in size (e.g., 1590), high sanitation (HS), pneumatic (P), seat material (SS or Flapper), ball material (— for flapper), and diaphragm material.

Seal Material		Controls		Accessories‡		Wash Bin		Certification	
<b>A</b>	Polychloro- prene	<b>1</b>	Exposed pneumatic, SST inflatable	<b>AA</b>	None	<b>0</b>	None	<b>C21</b>	EN 10204 type 2.1
<b>B</b>	EPDM	<b>2</b>	Enclosed pneumatic, SST inflatable	<b>AB</b>	Caster kit			<b>C31</b>	EN 10204 type 3.1
<b>C</b>	Buna	<b>3*</b>	Enclosed electro- pneumatic, SST inflatable	<b>AC</b>	Drum dolly Ram				
		<b>5</b>	Exposed pneumatic, SST static	<b>AE</b>	SST Ram piston rods				
		<b>6</b>	Exposed pneumatic, carbon steel, inflatable						
		<b>7</b>	Exposed pneumatic, carbon steel, static						

\* Not ATEX. Not intended for use in explosive or hazardous environments.

‡ For accessory descriptions, see [Kits and Accessories, page 73](#).

All models are rated:



and are FDA-compliant.

ATEX models with piston pumps  
are rated:



II 2 GD  
Ex h IIA T4 Gb X  
Ex h IIIB T100°C Db X

ATEX models with diaphragm  
pumps are rated:



II 2 GD  
Ex h IIA 82°C...160°C Gb X  
Ex h IIIB T135°C Db

Electro-pneumatic control panel  
component approval:



**Intertek** Conforms to UL STD 508A Certified  
**9902741** to CSA STD C22.2 No. 286

## Installation

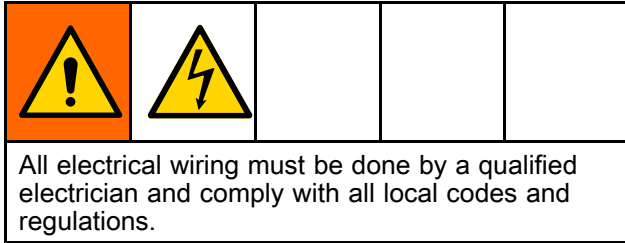

2. Make sure the surface is flat and that the SDU doesn't wobble.

**NOTE:** If the SDU is being located in a permanent location, use the four holes in the baseplate as a guide to locate where to drill holes for mounting hardware.

3. For ease of operation and service, locate the SDU so the fluid outlet port is easily accessible.

## General Information

The Typical Installation shown in **Fig. 1** is only a guide for selecting and installing system components.

Reference letters in the text, for example (A), refer to the callouts in the figures.

The SDU consists of parts which are stationary and parts attached to the air cylinder center shafts. The parts, such as the pump and ram plate, attached to the air cylinder center shafts will raise and lower (move) during normal operation. These moving parts comprise the ram.

Performing different steps in the operation of the SDU will require use of the controls located on the control panel. Refer to the table under the illustration that corresponds with the control panel installed on the SDU for the use of those controls. Learn what each control does before using the SDU in a production situation.

## Choosing a Location for the SDU

1. Choose a location for the SDU so the air controls are easily accessible. Ensure that there is enough space overhead for the ram to rise fully and the control box cover can be opened without interference. See [Dimensions, page 65](#).

## Unpacking the SDU

Before unpacking, examine packing materials for signs of damage. If damaged, take pictures of the damage and contact Graco for directions on how to proceed.

1. Remove packing materials and mounting bolts from the base.
2. Attach a hoisting strap around the upper end of each air cylinder, below the crossbar. Ensure that air hoses or laser sensor are not damaged by the straps.
3. Use a forklift or overhead hoist to lift the SDU off the shipping pallet.

**NOTE:** If using casters on a pneumatic unit, attach at this time.

4. Place the SDU at the desired location.
5. Permanently mount the electro-pneumatic unit.



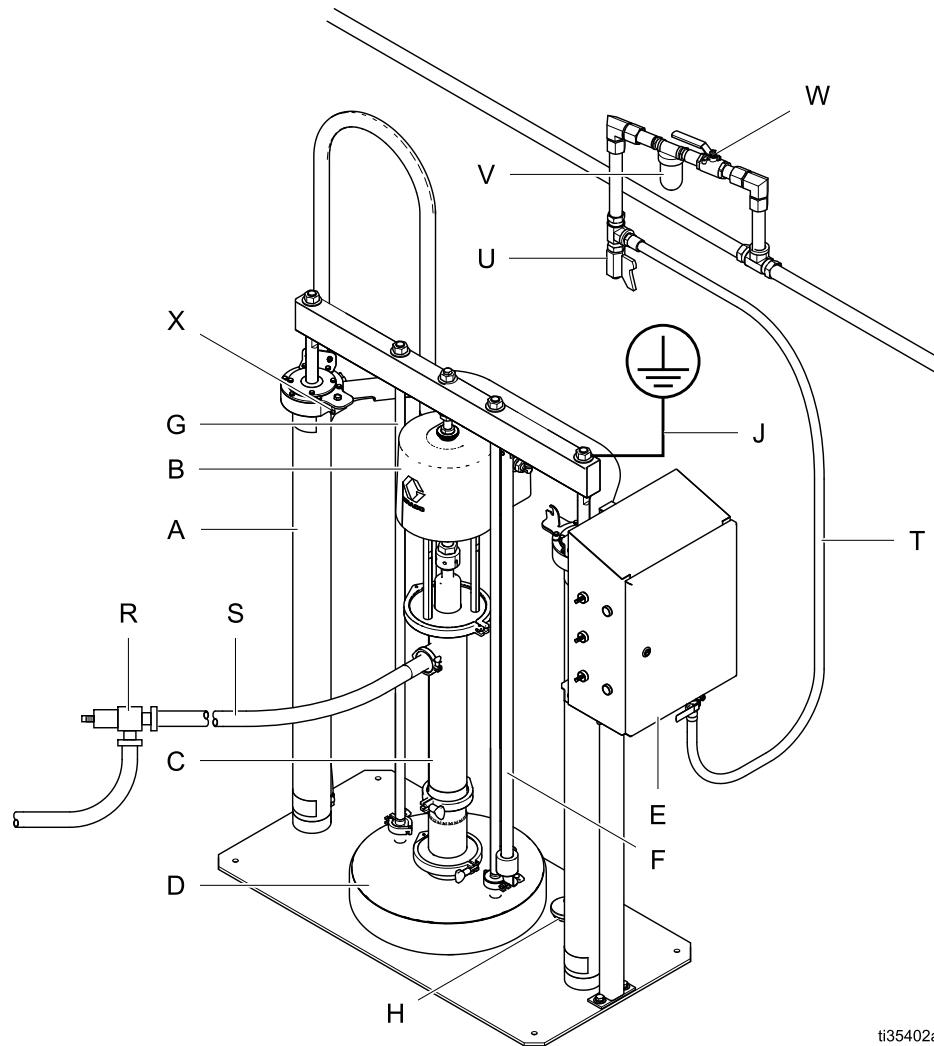

ti35402a

Fig. 1: Typical installation

**System Components**

A	Air cylinders
B	Air motor
C	Displacement pump
D	Ram Plate
E	Control Panel
F	Stop Rod
G	Ram Plate Support Rods
H	Drum Stops
J	Ground Cable Kit

**Required Accessories/Components Not Supplied**

R*	Outlet Line Pressure Relief Valve rated for the expected fluid working pressure of the pump
S	Fluid Line
T	Air Supply Line
U	Air Line Drain Valve
V	Air Filter
W	Bleed Type Air Shutoff Valve
X	Laser Sensor (Electro-pneumatic units only)

\* Only required if a valve or dispenser is downstream in the outlet line.

## Control Panel (Exposed)

When supplied with a continuous supply of air, the control panel can control the SDU functions for manual unloading of drums.

**NOTE:** An SDU that uses a static seal will not have inflatable seal components on the control panel.

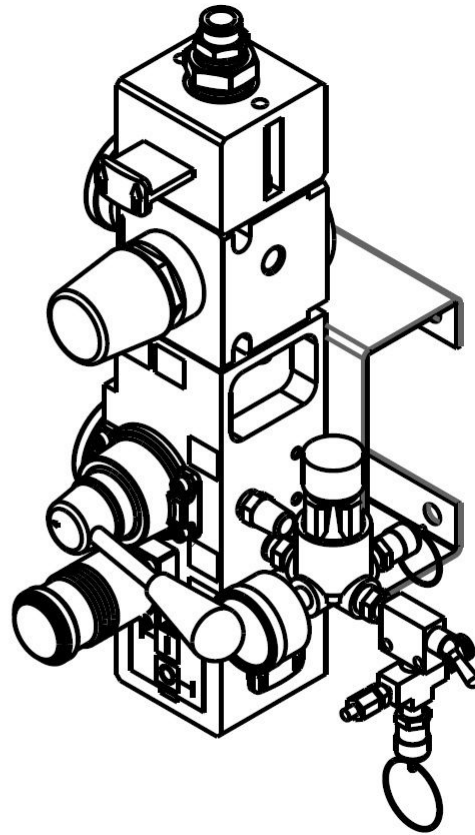
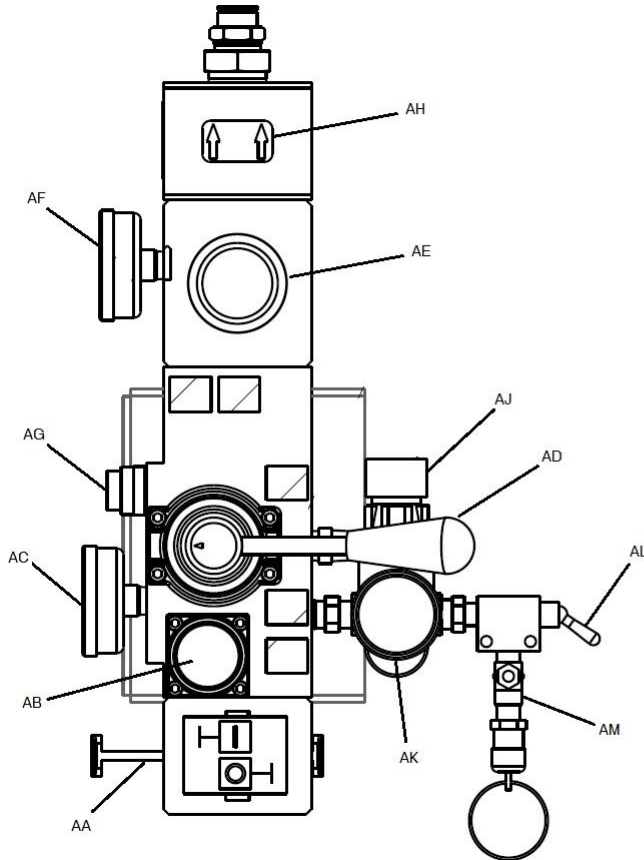

25D266

AA	Main air slider valve	Turns air on and off to the system. When closed, the valve relieves pressure downstream.
AB	Ram air regulator	Controls ram up and down pressure and air assist pressure.
AC	Ram air pressure gauge	Displays the air pressure used to raise and lower the ram.
AD	Ram director valve	Controls ram direction.
AE	Air motor regulator	Controls air pressure to the motor.
AF	air motor pressure gauge	Displays the air pressure used to drive the air motor.
AG	Air assist button	Turns air on and off to push the ram plate out of an empty drum.
AH	Air motor slider valve	Turns air on and off to the air motor. When closed, the valve relieves air trapped between it and the air motor. Push the valve to shutoff.
AJ	Seal air pressure regulator	Controls the air pressure used to inflate the seal.
AK	Seal air pressure gauge	Displays the air pressure used to inflate the seal.
AL	Seal inflate switch	Controls when air is applied to the seal.
AM	Pressure relief valve	Prevents overpressurization of the seal.

## Control Panel (Enclosed Pneumatic)

When supplied with a continuous supply of air, the control panel can control the SDU functions for manual unloading of drums.

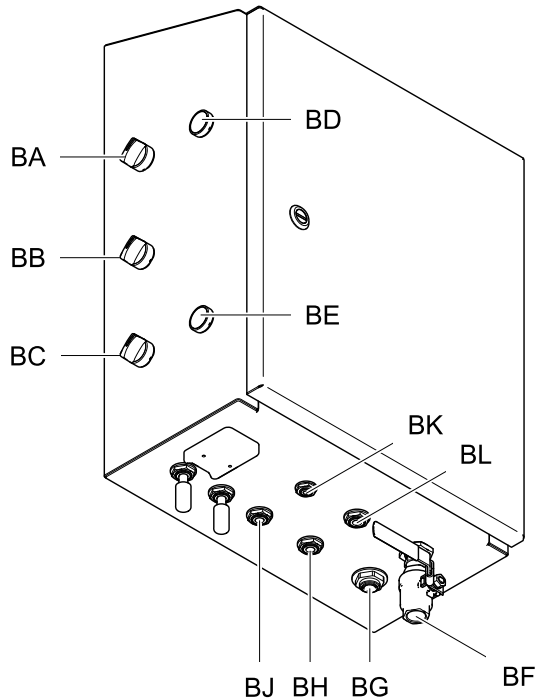

ti34786a

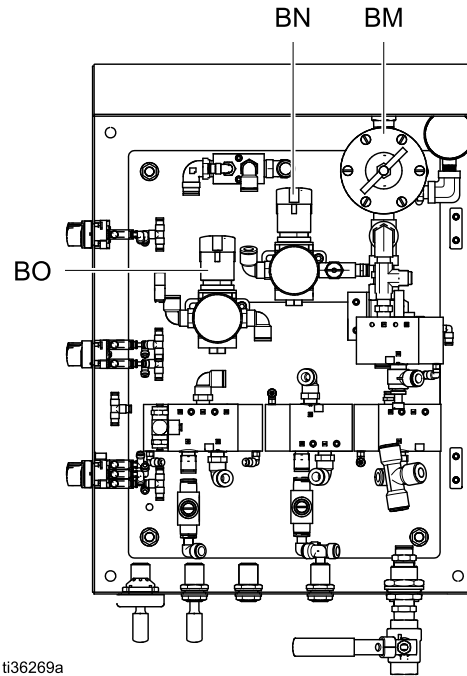

ti36269a

BA	Seal control switch	Controls when air is applied to the seal.
BB	Air motor control switch	Turns air on and off to the air motor. When closed, the valve relieves air trapped between it and the air motor.
BC	Ram position control switch	Controls ram direction.
BD	Air assist button	Turns air on and off to push the ram plate out of an empty drum.
BE	Ram jog button	While pressed, allows the ram to lower.
BF	Air supply valve	Connection for facility supply air to the SDU. Use only clean, dry air.
BG	Air motor air supply	Connection for supply air to the air motor.
BH	Ram cylinder bottom fittings	Connection for the bottom air cylinder fittings. Supplies air to raise the ram.
BJ	Air assist	Connection for the air supply to the air assist fitting on the ram plate.
BK	Seal air	Connection for the air supply to the inflatable seal.
BL	Ram cylinder top fittings	Connection for the top air cylinder fittings. Supplies air to lower the ram.
BM	Pump regulator	Controls pressure for supply air to the air motor.
BN	Seal regulator	Controls air pressure for supply air to the inflatable seal.
BO	Ram regulator	Controls air pressure for supply air to the ram cylinders.

## Control Panel (Electro-Pneumatic)

When supplied with 100–240 VAC power and a continuous supply of air, the control panel can control the SDU functions for automatic, manual, or batch unloading of drums.

This panel is UL508A certified and requires using only Listed or Recognized components. Replacing parts with genuine Graco parts is important to maintain this certification. See the parts manual for replacement part numbers.

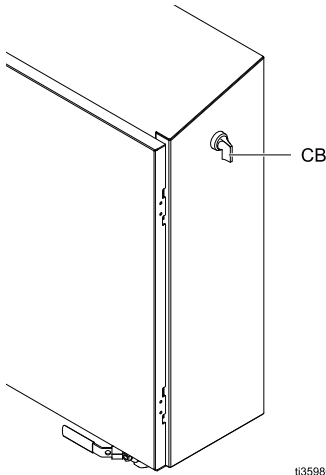

t135986a

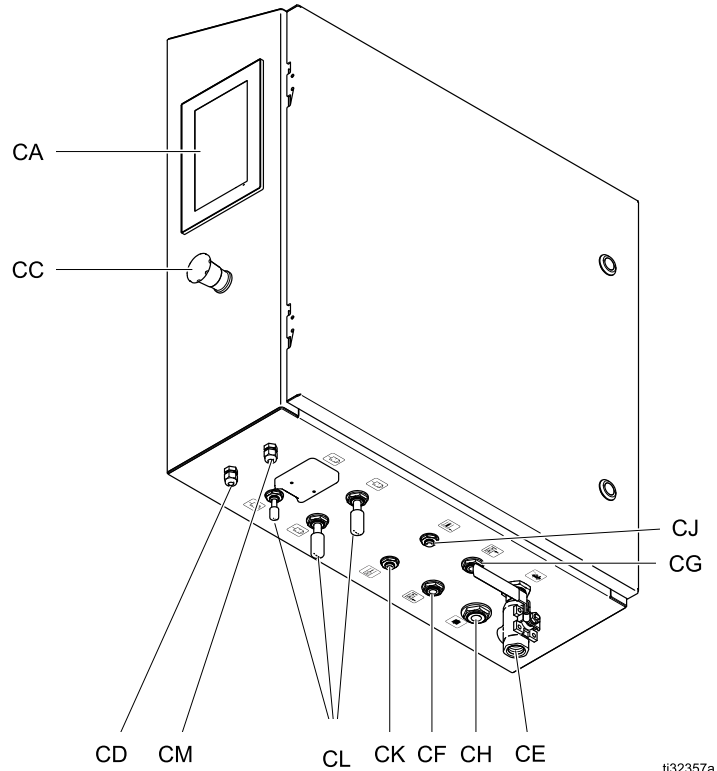

t132357a





CA	Touch screen display	Operator interface for control of the SDU.
CB	AC power switch	Controls whether power is applied to the control panel.
CC	Emergency stop button	Press to cease SDU operation immediately. This should not be used as a means to shut off the system during normal operation.
CD	Position sensor	Access hole and strain relief for the position sensor cable.
CE	Air supply valve	Connection for facility supply air to the SDU. Use only clean, dry air.
CF	Air cylinder bottom fitting air supply	Connection for the bottom air cylinder fittings. Supplies air to raise the ram.
CG	Air cylinder top fitting air supply	Connection for the top air cylinder fittings. Supplies air to lower the ram.
CH	Air motor air supply	Connection for supply air to the air motor.
CJ	Ram Plate seal air supply	Connection for the air supply to the inflatable seal.
CK	Air assist air supply	Connection for the air supply to the air assist fitting on the ram plate.
CL	Mufflers	Reduces sound of air expelled from the pump air motor.
CM	Auxiliary sensor	Access hole and strain relief for auxiliary sensor.

## Air Line Accessories

See Fig. 1.

- **Outlet Line Pressure Relief Valve (R):** provides a pressure relief path for the outlet line. Only needed if a valve is used downstream in the outlet line
- **Air line (T):** use 1/2 in. ID minimum air line. Larger ID is better, especially with line runs.
- **Air line drain valve (U)**
- **Air line filter (V):** removes harmful dirt and moisture from compressed air supply.
- **Second bleed-type air valve (W):** isolates air line accessories and supply system for servicing. Locate upstream from all other air line accessories.

## Grounding

				
<p>The equipment must be grounded to reduce the risk of static sparking and electric shock. Electric or static sparking can cause fumes to ignite or explode. Improper grounding can cause electric shock. Grounding provides an escape wire for the electric current.</p>				

Before operating the pump, ground the system as explained below.

- **Electro-pneumatic control panel:** If installed, it is grounded through the grounding conductor of the incoming power wiring.
- **Air and fluid hoses:** Use only grounded hoses with a maximum of 500 ft (150 m) combined hose length to ensure grounding continuity. Check electrical resistance of hoses. If total resistance to ground exceeds 29 megohms, replace hose immediately.
- **Dispense valve:** ground through connection to a properly grounded fluid hose and pump.
- **Fluid supply container:** Follow local code.
- **Solvent containers used when flushing:** Follow local code. Use only conductive metal containers, placed on a grounded surface. Do not place the container on a non-conductive surface, such as paper or cardboard, which interrupts grounding continuity.

- **SDU:** Attach the ground cables as shown. Attach the clamp end of the grounding wire to a true earth ground.

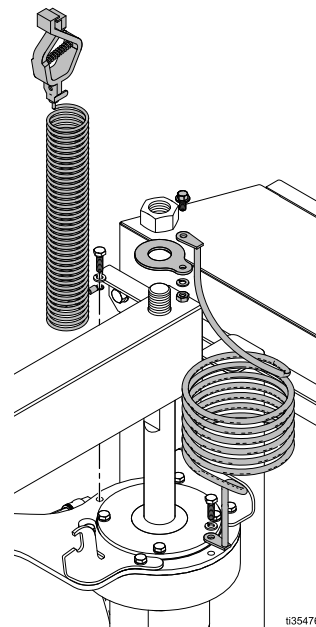

Check your system electrical continuity after the initial installation, and then set up a regular schedule for checking continuity to be sure proper grounding is maintained. The resistance should not exceed 1 ohm when measured between line ground and any metal on the system.

## AC Power

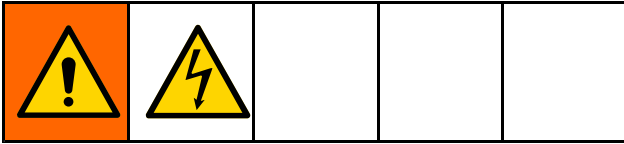

### NOTICE

Branch circuit protection and power disconnect to be provided by the installer per local code.

AC power is required for an unloader with an electro-pneumatic control panel.

1. Route wires to control panel through electrical conduit. Attach conduit using hole on bottom right hand side of enclosure with a type 4X rated conduit hub.
2. Attach the power system ground wire to the chassis ground lug (as shown) with 14 AWG stranded copper wire. Torque to 35 in-lbs (3.95 N•m).

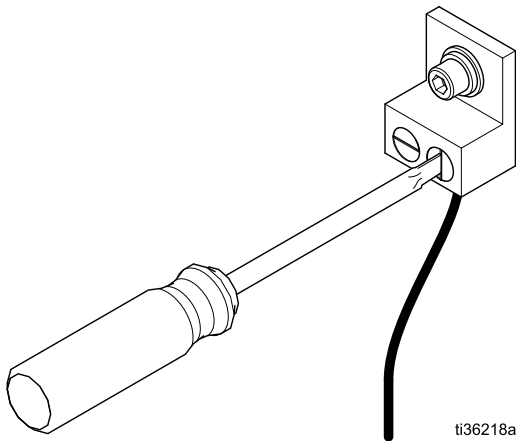

ti36218a

3. Connect equipment to 100 – 240 VAC, single phase, 50/60 Hz, 15 A service with 14 AWG stranded copper wire. Attach to L1 and L2 on power switch as shown. Torque to 8 in-lbs (0.9 N•m).

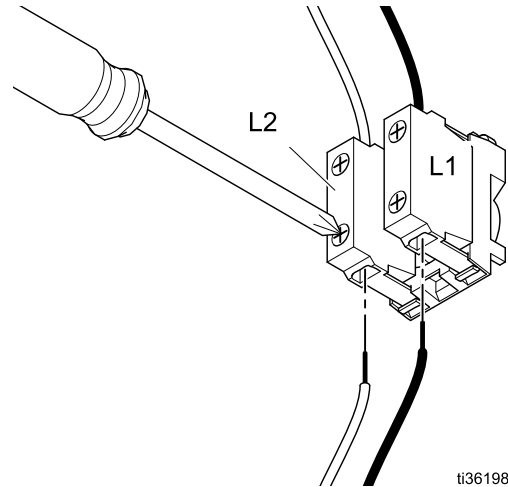



ti36198a

## Fluid Outlet Line

Connect a grounded, flexible fluid hose (S) to the fluid outlet port. The port is 2.0 in (50.8 mm) tri-clamp.

## Manual Ram Lock

				
<p>To reduce the chance of injury from the unexpected lowering of the ram while changing drums or working near the raised ram, engage the manual ram lock.</p>				

The manual ram lock operation is performed using the pin and collar at the bottom of the stop rod to engage the bracket on the top of the air cylinder closest to the control panel.

1. Raise the ram to the top of its travel.
2. Move the manual lock to the bracket on the right air cylinder, lift the collar, engage the pin into the notch of the bracket, and lower the collar over the bracket.

**NOTE:** If the ram has not been lowered to cause the pin to engage the bracket, the collar at the bottom of the lock arm will keep the lock arm in position over the bracket.

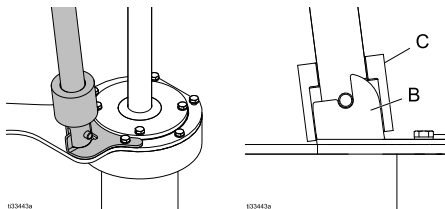

B – Ram lock bracket  
C – Ram lock collar

3. To disengage the manual lock arm, lift the collar above the bracket and move the lock arm away from the bracket and back onto the storage bracket on the ram plate support rod so that the manual lock arm is restrained from undesired movement.

**NOTE:** It may be necessary to raise the ram if the pin of the lock arm is firmly engaged in the bracket notch.

## Install a Ram Plate Inflatable Seal

This procedure assumes that no inflatable seal is currently installed on the ram plate and the ram plate is attached to the drum unloader assembly.

If the ram plate is detached from the pump lower, the inflatable seal can be installed entirely from the top of the ram plate. If a ram plate inflatable seal is currently installed, follow the procedure in [Remove a Ram Plate Inflatable Seal, page 16](#).

1. Raise the ram assembly to full height and engage the ram lock to prevent inadvertent ram lowering.
2. At the rear of the ram plate, insert the inflation tube through seal gasket (211) and then the access hole in the recessed groove and ensure that the hose protrudes out of the hole on the top of the ram plate.

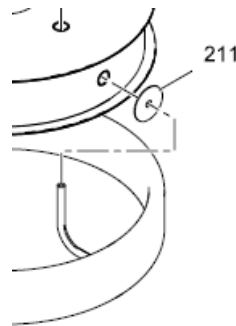

### NOTICE

To prevent damage to the seal or seal air hose, ensure that the inflation hose is properly centered in the ram plate hole.

3. Carefully center the inflation hose in the hole and press the seal into the ram plate groove. A flat is provided on the ram plate retaining flange to aid installation. Hold the seal in place and work around one side of the ram plate, working the seal into the ram plate groove. Repeat on the other side of the ram plate.

**NOTE:** A food-safe lubricant can be used to assist in sliding the seal over the ram plate lip, but is not required.

4. At the front of the ram plate, work the remainder of the seal over the ram plate lip, working to install the seal into the remaining portion of the ram plate groove.
5. Verify that the seal inflation tube is properly positioned in the hole at the back of the ram plate.
6. Attach the air supply for the seal.
7. Disengage the ram assembly lock.

## Remove a Ram Plate Inflatable Seal



This equipment stays pressurized until pressure is relieved manually. To help prevent serious injury from pressurized fluid, such as skin injection or splashing in the eyes or on skin, follow the [Pressure Relief Procedure, page 18](#) when you stop pumping and before you clean, check, or service the equipment.

This procedure assumes that an inflatable seal is currently installed on the ram plate and the ram plate is attached to the drum unloader assembly. If the ram plate is detached from the pump lower, the inflatable seal can be removed entirely from the top of the ram plate.

1. Raise the ram assembly to full height and engage the ram lock to prevent inadvertent ram lowering.
2. Complete the [Pressure Relief Procedure, page 18](#) before continuing.
3. Detach the air supply for the seal.
4. At the front of the ram plate, work the seal over the ram plate lip to remove the inflatable seal from the ram plate groove. A flat is provided on the ram plate retaining flange to aid in seal removal. Repeat on the other side of the ram plate.

**NOTE:** A food-safe lubricant can be used to assist in sliding the seal over the ram plate lip, but is not required.

5. At the rear of the ram plate, pull the inflation tube through the access hole in the recessed groove and the seal gasket (211).

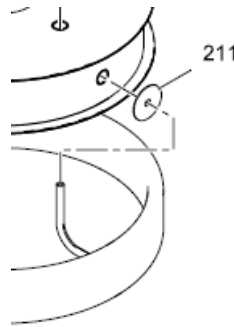

### NOTICE

To prevent damage to the seal or seal air hose, ensure that the inflation hose is properly centered in the ram plate hole.

6. Once the inflatable seal is removed, follow the procedure in [Install a Ram Plate Inflatable Seal, page 15](#) to install a new ram plate inflatable seal.



## Adjust Drum Stops



### NOTICE

To prevent pinching or damaging the seal during drum insertion, only inflate the seal when the top lip of the ram plate is at, or below, the top edge of the drum.

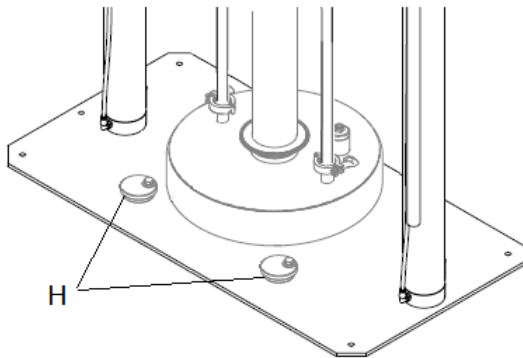

The drum stops are a cam which will allow adjustment for different types of drums.

1. Loosen the bolt in each drum stop (H) and rotate them away from the ram plate.
2. Raise the ram assembly.
3. Place an empty drum on the SDU baseplate.
4. Lower the ram assembly near the top of the drum.
5. Position the drum to properly align with the ram plate.

6. Lower the ram assembly partially into the drum and inflate the ram plate seal (if applicable).
7. Rotate each drum stop to contact the drum and tighten the drum stop bolts.
8. Deflate the ram plate seal (if applicable), raise the ram assembly, and remove the empty drum.

## System Setup (Pneumatic Control)

1. Connect supply air.
2. Adjust air pressure settings for control functions.
3. Adjust drum stops for use with desired drums.
4. Connect outlet fittings and hoses.
5. Perform test drum unload. See [Start and Adjust the Pump, page 20](#).

## System Setup (Electro-pneumatic Control)

1. Apply power.
2. Connect supply air.
3. Adjust drum stops for use with desired drums.
4. Set SDU parameters. See [System Configuration Screen, page 47](#).
5. Define recipes. See [Recipe Screens, page 33](#).
6. Connect outlet fittings and hoses.
7. Perform test drum unload.

# Operation



## Pressure Relief Procedure



Follow the Pressure Relief Procedure whenever you see this symbol.



This equipment stays pressurized until pressure is relieved manually. To help prevent serious injury from pressurized fluid, such as skin injection or splashing in the eyes or on skin, follow the [Pressure Relief Procedure, page 18](#) when you stop pumping and before you clean, check, or service the equipment.

### 1. For exposed manual pneumatic control:

- a. Close the air motor slider valve (AH) and the main air slider valve (AA).  
**NOTE:** Both are relieving air valves.
- b. Open a pressure relief valve on the outlet line.
- c. Set the ram director valve (AD) to DOWN. The ram will slowly move to the bottom of its travel.
- d. Jog the ram director valve (AD) up and down to bleed air from ram cylinder.

### 2. For enclosed pneumatic control:

- a. Turn all regulators to zero pressure.
- b. Open a pressure relief valve on the outlet line.
- c. Toggle the ram position control switch (BC) up and down to bleed air from the ram cylinders. The ram will slowly move to the bottom of its travel.
- d. Close the air supply valve.

### 3. For electro-pneumatic control:





- a. Stop evacuation activity.
- b. Open a pressure relief valve on the outlet line.
- c. Navigate to the [System Configuration screen, page 47](#). Press the Shutdown/Depressurize icon. When pressed, a pop-up will appear indicating the system is depressurizing. The ram will slowly move to the bottom of its travel.
- d. The pop-up will indicate if depressurization was completed successfully. Close the air supply valve (CE).

**NOTE:** A pressure alarm will appear after supply air is removed.

## Clean the Pump Before First Use

The pump should be cleaned prior to first use to remove any potential contaminants. See the pump manual for cleaning instructions.

## Start and Adjust the Ram

				
<ul style="list-style-type: none"> <li>Seal burst may cause flying debris or product resulting in eye injury. Do not force fully inflated seal into the drum. Do not inflate the seal when not installed on the ram plate. Wear safety glasses when operating the system.</li> <li>The ram plate or the pump inlet can pinch fingers resulting in serious injury. Keep hands and fingers away from the rim of the fluid container when raising or lowering the ram. Keep fingers away from the pump inlet.</li> </ul>				

The following steps require supply air to be supplied to the SDU.

Prepare drum location.

### 1. Exposed control panel:

- Open the air supply to the control panel.
- While observing the position of the ram assembly in relation to surrounding obstacles, operate the ram director valve to the up position to raise the ram assembly to its maximum height.
- Position an empty drum against the drum stops.
- Using the ram director valve, slowly lower the ram plate to a point just above the opening in the top of drum and release the valve. Position the empty drum to be centered on the ram plate.
- If the drum is not properly positioned under the ram plate, see [Adjust Drum Stops, page 17](#) to adjust the drum stops.

### 2. Enclosed pneumatic control panel:

- Open the air supply to the control panel.
- While observing the position of the ram assembly in relation to surrounding obstacles, operate the ram button to the up position to raise the ram assembly to its maximum height.
- Position an empty drum against the drum stops.
- Using the Ram Jog pushbutton, slowly lower the ram plate to a point just above the opening in the top of drum and release the Ram Jog pushbutton.
- If the drum is not properly positioned under the ram plate, see [Adjust Drum Stops, page 17](#) to adjust the drum stops.

### 3. For electro-pneumatic control panel:

- Turn on the control panel power switch (CB).
- At the air supply, open control panel supply air ball valve (CE) to the control box.
- Navigate to the manual operation screen. While observing the position of the ram assembly in relation to surrounding obstacles, press the Ram Up icon. When the ram assembly reaches its maximum height, press the Ram Hold icon.
- Position an empty drum under the ram plate.
- Using the Ram Jog icon, slowly lower the ram plate to a point just above the opening in the top of drum and position the empty drum for accurate ram plate alignment with the drum.
- If the drum is not properly positioned under the ram plate, see [Adjust Drum Stops, page 17](#) to adjust the drum stops.

## Start and Adjust the Pump



Keep hands and fingers away from the ram plate, pump fluid inlet, and lip of the fluid container when raising or lowering the ram to reduce risk of serious injury from moving parts.

### NOTICE

To prevent pinching or damaging the seal during drum insertion, only inflate the seal when the top lip of the ram plate is at, or below, the top edge of the drum.

To prevent the seal from restricting smooth movement of the ram plate within the drum, only inflate the seal until it makes contact around the perimeter of the drum.

#### 1. For Exposed Control Panel:

- a. Connect pump outlet fittings and hose (not supplied).  
**NOTE:** Be sure all components are adequately sized and pressure rated to meet the system's requirements.
- b. Using the ram director valve, lower the ram plate into the drum until it contacts the product.
- c. If the system is equipped with an inflatable seal and the ram plate is located far enough into the drum to properly inflate the seal, inflate it now. If the ram plate is not far enough into the drum for seal inflation, wait until enough product has been evacuated to lower the level of the ram plate in the drum before inflating.
- d. Move the air motor slider valve to the 1 (open) position. Observe that the pump begins to operate. Adjust air motor air pressure as needed.
- e. Move the ram director valve to the down position. Observe that the ram lowers as product is evacuated. Adjust ram air pressure as needed.
- f. If using an inflatable seal and it has not yet been inflated and the ram plate has lowered far enough into the drum, inflate it now.
- g. Using the pressure settings for the various functions, fine-tune the pressures as needed.

**NOTE:** Increase air pressure to the ram if the pump does not prime properly with heavier fluids. Decrease air pressure if material is forced out around the ram plate seal.

#### 2. For Enclosed Pneumatic Control Panel:

- a. Connect pump outlet fittings and hose (not supplied).  
**NOTE:** Be sure all components are adequately sized and pressure rated to meet the system's requirements.
- b. Using the ram position control switch, lower the ram plate into the drum until it contacts the product in the drum.
- c. If the system is equipped with an inflatable seal and the ram plate is located far enough into the drum to properly inflate the seal, inflate it now. If the ram plate is not far enough into the drum for seal inflation, wait until enough product has been evacuated to lower the level of the ram plate in the drum before inflating.
- d. Move the air motor control switch to the run position. Observe that the pump begins to operate. Adjust air motor air pressure as needed.
- e. Move the ram position control switch to the down position. Observe that the ram lowers as product is evacuated. Adjust ram air pressure as needed.
- f. If using an inflatable seal and it has not yet been inflated and the ram plate has lowered far enough into the drum, inflate it now.
- g. Using the pressure settings for the various functions, fine-tune the pressures as needed.

**NOTE:** Increase air pressure to the ram if the pump does not prime properly with heavier fluids. Decrease air pressure if material is forced out around the inflatable seal.

3. **For Electro-pneumatic Control Panel:**

- a. Connect pump outlet fittings and hose (not supplied).

**NOTE:** Be sure all components are adequately sized and pressure rated to meet the system's requirements.





- b. Be sure the pump is set to pause. Set the ram down air pressure to 10 psi (0.06 MPa, 0.6 bar).
- c. Touch ram jog icon and lower the ram until it just contacts the product.
- d. If the ram plate is inside the drum, inflate the seal.

**NOTE:** To prevent damage to the seal, use the lowest seal pressure that still allows the seal to contact the inside surfaces of the drum.

- e. Start the pump at the slow (turtle) speed setting until the pump is primed. If necessary, adjust the pump pressure.
- f. Press the Ram Down icon.
- g. Using the pressure settings for the various functions, fine-tune the pressures as needed.

**NOTE:** Increase air pressure to the ram if the pump does not prime properly with heavier fluids. Decrease air pressure if material is forced out around the inflatable seal.



## Change the Drum

				
<p>Excessive air pressure in the material drum could cause the drum to rupture, causing serious injury. The ram plate must be free to move out of the drum. Never use blowoff air while the ram plate seal is inflated.</p>				

1. Turn off the pump.
2. Raise the ram plate out of the drum:
 

**NOTE:** When raising the ram, the vacuum between drum or its contents and the ram plate must be broken by use of the blowoff button. When the air assist (blowoff) button is pushed, the facility-supplied air supply raising the ram is diverted to the blowoff connection on the ram plate and creates a pressure to release the ram plate from the drum or its contents.

  - a. Deflate the ram plate seal.
  - b. Raise the ram out of the drum.
  - c. If the ram raises the drum off of the base, press the air assist (blowoff) button to break the vacuum between the ram plate and product.
  - d. When the ram plate is free of the drum and the ram reaches its full height, leave the ram control in the UP setting or use the manual ram lock. See [Manual Ram Lock, page 15](#).
3. Remove the empty drum.

				
<p>To reduce the risk of injury, including pinching fingers, while cleaning material from the ram plate, relieve pump pressure before using tools to clean. Follow the <a href="#">Pressure Relief Procedure, page 18</a>.</p>				

4. Inspect the ram plate and, if necessary, remove any remaining material or material build-up.
  - a. Perform pump pressure relief. See [Pressure Relief Procedure, page 18](#).
  - b. Use a tool to remove material build-up.
5. To empty another drum, perform the steps of [Start and Adjust the Ram, page 19](#).



## Emergency Stop

The SDU electro-pneumatic control box has an emergency stop button (CC) below the display screen. Pressing the emergency stop button will stop the pump but does not depressurize the system. Resetting the emergency stop places the system in a ready state. The system must be restarted by the operator.

To reset the emergency stop button, rotate the knob in a clockwise direction until a click is heard or felt.

Do not use the emergency stop button to stop the system during normal operation.

## Pump Shutdown

				
---	--	---	--	--

At the end of the work shift and before you check, adjust, clean, or repair the system, follow the [Pressure Relief Procedure, page 18](#).



# Maintenance

## Lubrication

The pump is lubricated at the factory. It is designed to require no further lubrication for the life of the packings. There is no need to add an inline lubricator under normal operating conditions.

## Cleaning the Ram Plate

This procedure only pertains to cleaning the ram plate. If the pump lower also needs to be cleaned, perform [Cleaning the Pump Lower, page 24](#) instead.

				
<p>This equipment stays pressurized during the removal of the ram plate from the pump. To help prevent serious injury from moving parts while you remove the ram plate for cleaning, keep fingers above the ram plate. Do not attempt to grab the ram plate at the edges while it is above the baseplate.</p>				

When done using the SDU for the day, or when cleaning is needed so that a different product can be pumped, perform the following:



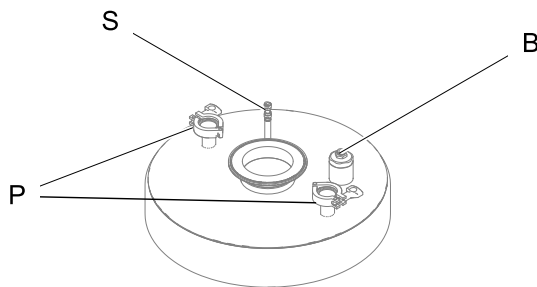

1. Remove the drum. See [Change the Drum, page 22](#).
2. Perform the [Pressure Relief Procedure, page 18](#).
3. Lower the ram so that the ram plate is resting flat against the baseplate.
4. Disconnect the blowoff air hose and ram plate seal air tube at the ram plate.



- B** Blowoff air hose attachment location
- P** Ram plate support rod attachment locations
- S** Seal air hose attachment location

5. Remove the clamp at the large flange connection where the ram plate attaches to the pump lower and remove the ram plate mounting clamps where the ram plate attaches to the ram plate support rods.
6. If the ram plate doesn't independently separate from the pump, use the air controls to slightly raise the ram plate and pump off the baseplate. Then, using open hands on opposite sides of the ram plate, apply downward hand pressure to break the seal. When the ram plate is loose from the pump lower unit, continue raising the ram until the pump lower unit clears the ram plate. Stop raising the ram.
7. Slide the ram plate out from under the pump lower and lower the ram as far as possible.
8. If more than flushing of the pump is necessary, follow the steps in [Cleaning the Pump Lower, page 24](#).
9. Clean the ram plate:
  - a. Remove the ram plate inflatable seal or disassemble the static wiper seal.
  - b. Open the blowoff assembly and clean if necessary. Inspect parts prior to reassembly.
  - c. Use a cleaning solution compatible with the product being unloaded and the materials of ram plate construction.
  - d. Reassemble the ram plate assembly. For directions on installing a ram plate seal, see [Install a Ram Plate Inflatable Seal, page 15](#).
  - e. Locate the ram plate under the pump lower. Move fingers and tools out of the way and slowly lower the pump into the ram plate.
10. Attach the ram plate to the pump lower and re-attach the blowoff air hose, seal air hose, and ram plate support rods to the ram plate.

## Cleaning the Pump Lower

				
<p>This equipment stays pressurized during the removal of the ram plate and pump lower from the pump. To help prevent serious injury from moving parts while you remove the parts for cleaning, keep fingers above the ram plate. Do not attempt to grab the ram plate at the edges while it is above the baseplate.</p>				

When done using the SDU for the day, or when cleaning is needed so that a different product can be pumped, perform the following:

1. Remove the drum. See [Change the Drum, page 22](#).
2. Perform the [Pressure Relief Procedure, page 18](#).
3. Lower the ram so that the ram plate is resting flat against the baseplate.
4. Disconnect the blowoff air hose and ram plate seal air hose at the ram plate.

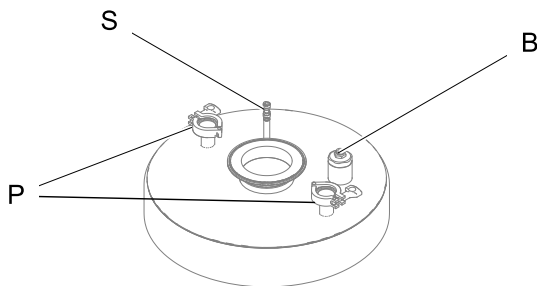

- B** Blowoff air hose attachment location
- P** Ram plate support rod attachment locations
- S** Seal air hose attachment location

5. Remove the ram plate mounting clamps where the ram plate attaches to the ram plate support rods.
6. Refer to the pump manual for instructions on how to disconnect the pump lower from the air motor.

7. Raise the ram assembly to lift the air motor off of the pump lower. Stop raising the ram when the air motor clears the pump lower.
8. Slide the ram plate and pump lower out from under the air motor.
9. Clean the pump lower. See the pump manual for instructions on cleaning.
10. Clean the ram plate. See [Cleaning the Ram Plate, page 23](#).
11. Once all ram plate and pump lower parts are cleaned, install the ram plate and pump lower on the air motor. Attach all air fittings and flange clamps.

## Flushing and Storage

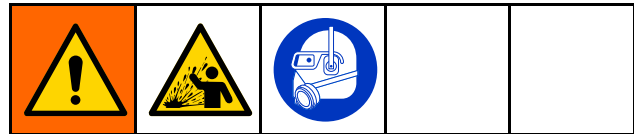

- Flush before fluid can dry in the equipment, at the end of the day, before storing, and before repairing equipment.
- Flush at the lowest pressure possible. Check connectors for leaks and tighten as necessary.
- Flush with a fluid that is compatible with the fluid being dispensed and the equipment wetted parts.
- Always flush the pump and relieve the pressure before storing it for any length of time.
- For long-term storage, thoroughly clean and dry the pump and ram plate parts.

### NOTICE

Flush the pump often enough to prevent the fluid you are pumping from drying or freezing in the pump and damaging it. Store the pump at 32°F (0°C) or higher. Exposure to extreme low temperatures may result in damage to plastic parts.



# Electro-pneumatic Control Panel Display Screens



The display screen is a touch screen. The screen can be damaged by pointed or sharp objects. Use only fingertips to make selections on the display.

**NOTE:** Selection fields and icons that are grayed-out on the screens are not currently active.

When the system is powered up, the Automatic run screen is displayed. The first time the unloader system is powered up, it will be necessary to perform system setup. See [System Configuration Screen, page 47](#).

On modifiable fields, touching the field will cause either a numeric keypad or alphanumeric keyboard to display. The keyboard or keypad are determined by the type of entry allowed in the selected field.

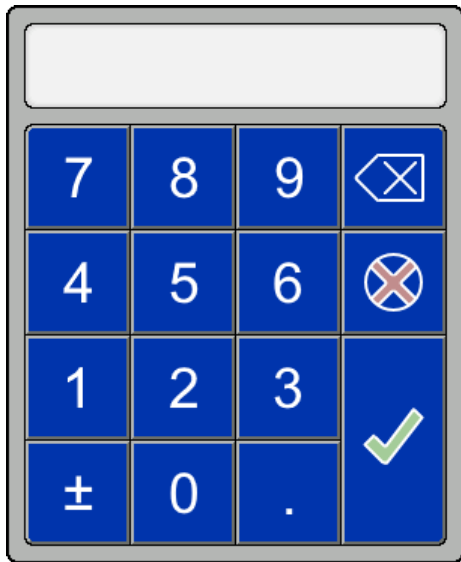

Numeric keypad

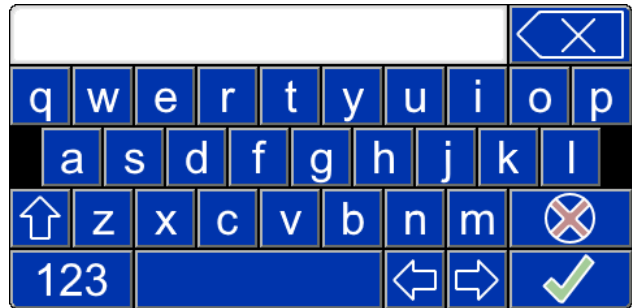

Keyboard alphabet pad

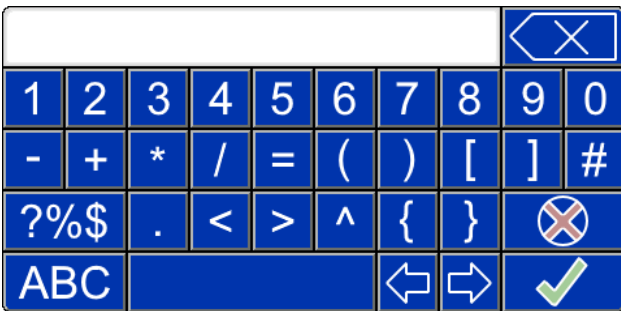



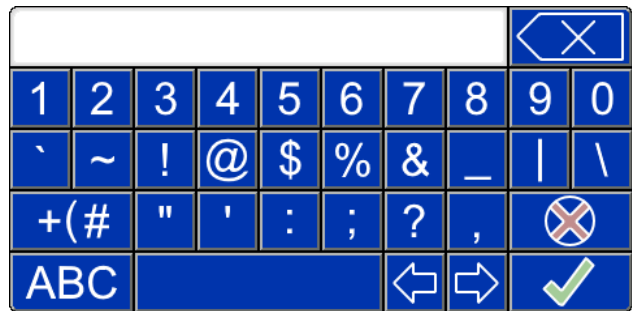

Keyboard numbers and symbols screen 1







Keyboard numbers and symbols screen 2

**Specialty key definitions**

Key	Description
	<b>Exit</b> Exit the keyboard or keypad. If the entry has not been saved, any displayed entry shown in the top field of the keyboard or keypad is lost.
	<b>Backspace</b> Erase the last character of the displayed entry in the top field of the keyboard or keypad. This key will erase one character each time it is pressed, or multiple if pressed and held.
	<b>Enter</b> When the desired value has been entered in the top field of the keyboard or keypad, press the Enter key to save the value in the selected field on the display screen.
	<b>Shift</b> The shift key is a toggle between upper- and lower-case letters. When pressed, the selected case is used on each key selected until the Shift key is pressed again. Switching screens will reset the shift to lowercase on the new screen.
	<b>Polarity</b> This key toggles the number in the Number Keypad between positive and negative.

**Function Keys**

Key	Description
	<b>Run</b> Select the run screens. <ul style="list-style-type: none"> <li>• Automatic</li> <li>• Manual</li> </ul>
	<b>Recipes</b> Create or edit recipes. <ul style="list-style-type: none"> <li>• Material Recipes</li> <li>• Container Recipes</li> </ul>
	<b>Logs</b> View available logs. <ul style="list-style-type: none"> <li>• Event Log</li> <li>• Job Log</li> </ul>
	<b>Settings</b> Configure the SDU and connected devices. <ul style="list-style-type: none"> <li>• System Configuration Screen: Edit system configuration</li> <li>• I/O Screen: Edit feedback and I/O settings, view I/O status</li> <li>• Network Screen: Configure settings for network communication</li> <li>• About: Display system and software information</li> </ul>

## **Startup Screen**

When the power ON/OFF switch is turned ON, the display shows the startup screen while the system prepares the system for operation.



## Automatic Screen

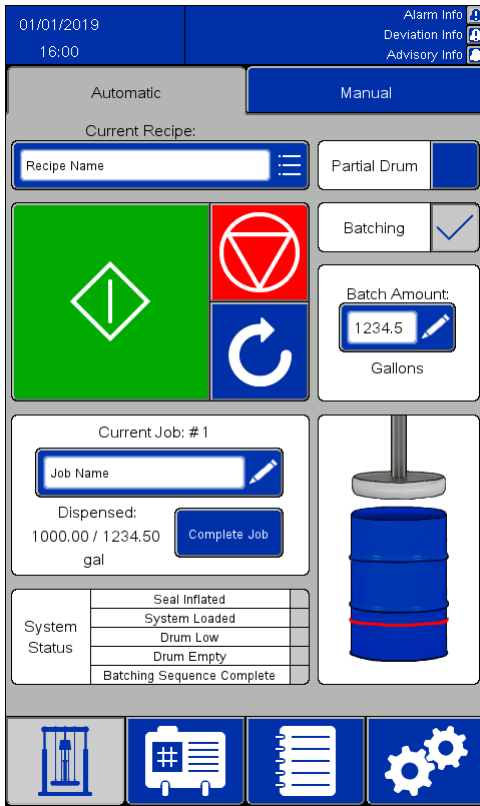

Feedback enabled

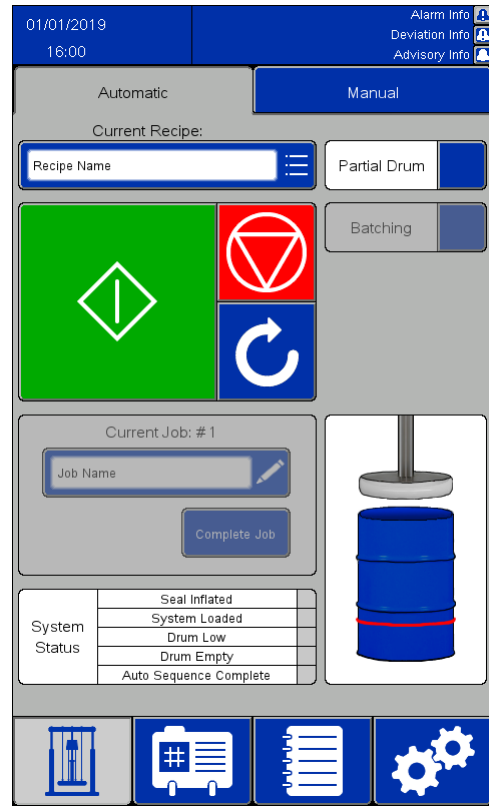





Feedback disabled

### NOTES:





- To prime a full drum for automatic operation, press and hold the green start button to advance the ram plate downwards. Before reaching the top of the drum, the pump will begin to pump slowly and the ram plate seal will partially inflate so that an overfilled drum will not spill over. Continue holding the start button until the ram plate is below the top of the drum and the automatic sequence takes over. If this button is released prior to the automatic sequence beginning, ram plate movement will cease. Press and hold the start button to resume.
- When the partial drum setting is selected, pump operation is delayed until the start button is released and the ram plate is located below the rim of the drum. If the ram plate is not below the

rim of the drum when the start button is released, ram movement ceases.

- If feedback is enabled in system settings:
  - The Current Job field is active. The Current Job box logs how much material has been dispensed since the previous job was completed.
  - The Batching checkbox is active. Selecting the Batching checkbox enables the Batch Amount numeric field and enters the value defined in the selected recipe Default Batch Size field. When the specified amount has been dispensed, the evacuation will cease and await further instruction.
- If Remote Operation is enabled for your SDU, see [Remote Operation, page 30](#).

Icon / Field	Description
<b>AUTO SEQUENCE</b>	
<b>Current Recipe</b>	Name of the recipe selected for unloading this drum. Click in this field to display the recipe selection screen.
	<b>Start</b> Begin drum unloading at the current state of the automatic sequence. If the sequence was stopped before completing, the drum unloading resumes at the point where the unloading was stopped.
	<b>Stop</b> Stop drum unloading. If the automatic sequence is not complete, the drum unloading status is retained so that the sequence can be completed if started again.
	<b>Reset</b> Resets the automatic sequence state, deflates the seal, and if "Auto Raise" is selected in the current recipe, will raise the ram.
	<b>Auto Sequence Enabled</b> Flashes in the upper-left corner of the screen next to the date and time once the automatic sequence has been activated. Once the sequence is fully enabled, the icon will also flash over the Start button. <b>NOTE:</b> If the Start button is released too soon during the loading process, then the sequence will stop. The icon will still flash next to the date and time to show that loading started, but did not finish. To continue the automatic sequence, press and hold the Start button until the icon flashes over the Start button.
<b>Partial Drum</b>	Available settings: <input checked="" type="checkbox"/> Partial drum <input type="checkbox"/> Not a partial drum
<b>Batching</b>	If checked, unload the batch size specified in the Batch Amount field. If unchecked, unloading will not automatically stop until the drum has been emptied.
	Ram position in the drum. <b>Note:</b> The red line indicates the approximate ram plate position at which the Drum Low status flag will be set.
<b>STATUS MESSAGES</b>	
Available statuses: <input type="checkbox"/> Condition not met <input checked="" type="checkbox"/> Condition met	
<b>Seal Inflated</b>	The ram plate seal is inflated.
<b>System Loaded</b>	The pump is primed and ready to evacuate the drum. This is based on the pump primed timer.
<b>Drum Low</b>	Ram assembly has reached the Drum Low position.
<b>Drum Empty</b>	Ram assembly has reached the Drum Empty position.
<b>Auto Sequence Complete</b>	The actions specified by the selected recipe have been completed. When this state is achieved, all other status states are cleared.
<b>Batching Sequence Complete</b>	Displays when Batching has been enabled. When lit, indicates that the dispensed material value specified is achieved.

## Remote Operation

				
<p>To avoid injury due to unexpected machine operation initiated by a remote controller, press the Stop button on the screen before servicing the equipment.</p> <p>If the Auto Sequence Enabled icon (  ) is flashing, do not service the equipment.</p>				

Use either of the following two system inputs to enable Remote Operation of the pump:

- Discrete input to AUX1 or AUX2. See [Feedback Control Screen, page 49](#).
- Network communication to a remote controller. See [Ethernet/IP, page 53](#).

To load and pump using remote operation:

1. Press the Start button on the screen of your SDU to manually begin the automatic or batch sequence. Let the automatic sequence run until the plate is detected inside the container and the pump primes.

**NOTE:** To ensure that the automatic sequence is fully enabled, check that the Auto Sequence

Enabled icon (  ) is flashing in the upper-left corner of the screen *and* flashing over the Start button. If the Auto Sequence Enabled icon is not flashing over the Start button, press and hold the Start button on the screen of your SDU until the Start button appears depressed and the Auto Sequence Enabled icon flashes over the Start button.

2. Use the established remote connection to assert the Start/Stop command and control the pump.

**NOTE:** If the Start/Stop command of the remote connection is asserted, the pump will run. If the command is not asserted, the pump will stop until the command is asserted again.



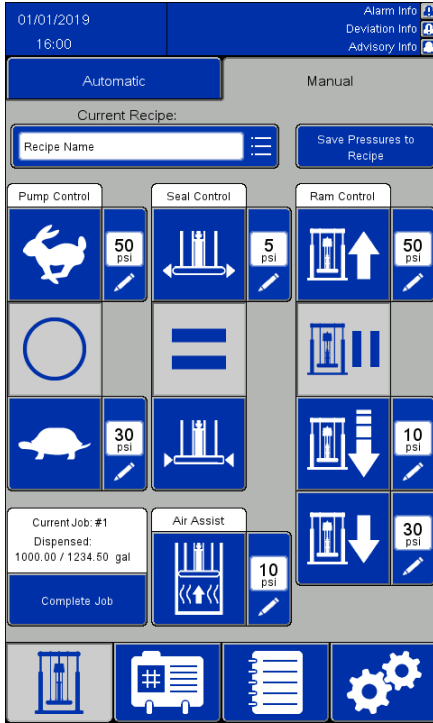

**NOTE:** The system will halt and the remote connection will not have control if the automatic or batch sequence is stopped by pressing the Stop button or by an alarm occurring. To resume the sequence and re-establish remote connection, press the Start button on the SDU screen.





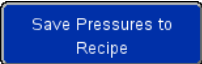



## Manual Screen



### NOTES:

- These buttons are disabled while the automatic sequence is operating.
- Locked recipes disable editing for the pressure boxes on this screen.

Icon/Field	Description
<b>Current Recipe</b>	Name of the recipe selected for unloading this drum. Click in this field to display a recipe selection screen.
	Press to save changed pressure settings of the current recipe. If no pressure changes have been made to the current recipe, this icon is not enabled. If the recipe is locked, this feature will not function.
	Numeric displays next to the icons are the pressure settings defined in the current recipe. Changes entered here are not saved to the recipe unless the Save Pressures to Recipe icon is pressed. A locked recipe will not allow changing these settings.
<b>Pump Control</b>	
	<b>Pump Fast</b> Press to run the pump at a fast speed.
	<b>Pump Off</b> Press to stop the pump.
	<b>Pump Slow</b> Press to run the pump at a slow speed.

Icon/Field	Description
<b>Seal Control</b>	
	<b>Seal Inflate</b> Press to inflate the ram plate seal.
	<b>Stop seal action</b> Stop inflating or deflating the seal. To resume, press the desired seal action button, inflate or deflate.
	<b>Seal Deflate</b> Press to deflate the ram plate seal.
<b>Batch Information</b>	
<div style="border: 1px solid black; padding: 5px; width: fit-content;">Current Job: #1 Dispensed: 1000.00 / 1234.50 gal</div>	<b>Current Job</b> Details of the current batch. This element is only active if feedback has been enabled on the I/O Settings Screen.
	<b>Complete Job</b> Press to mark the current batch as complete. Do not press if the intention is to restart the current batch again.
<b>Air Assist</b>	
	<b>Air Assist</b> Press and hold to blow air between the ram plate and the product to break the adhesion between the two. The ram plate seal should be deflated before performing this operation.  <b>NOTE:</b> Air assist will not operate unless Ram Up or Ram Hold is also selected.
<b>Ram Control</b>	
	<b>Ram Up</b> Momentarily press to raise the ram assembly. The ram will continue raising until the ram has reached the top of its travel, unless manually stopped by pressing Ram Hold.
	<b>Ram Hold</b> Momentarily press to keep the ram at the current location. <b>NOTE:</b> This is an active hold and the system may momentarily energize Ram Up to keep the ram plate from drifting. Active hold is enabled for 5 seconds after any Pump, Ram, Seal, or Air Assist command.
	<b>Ram Jog</b> Press and hold to lower the ram assembly. Releasing the button will stop lowering the ram.
	<b>Ram Down</b> Momentarily press to lower the ram to the lowest position. The ram will continue lowering until the ram has reached the bottom of its travel, unless manually stopped by pressing Ram Hold.



## **Recipe Screens**

Recipes define preset settings for unloader operation when unloading defined products. If the SDU will be operated manually, it is not necessary to define all recipe settings. However, the current recipe should be unlocked if the ability to adjust the pressures on the manual screen is desired.

Material Recipe screens contain settings based on the material being pumped. A maximum of 100 material recipes can be defined.

Container Recipe screens contain settings based on the design of the container being evacuated. A maximum of 20 container recipes can be defined.







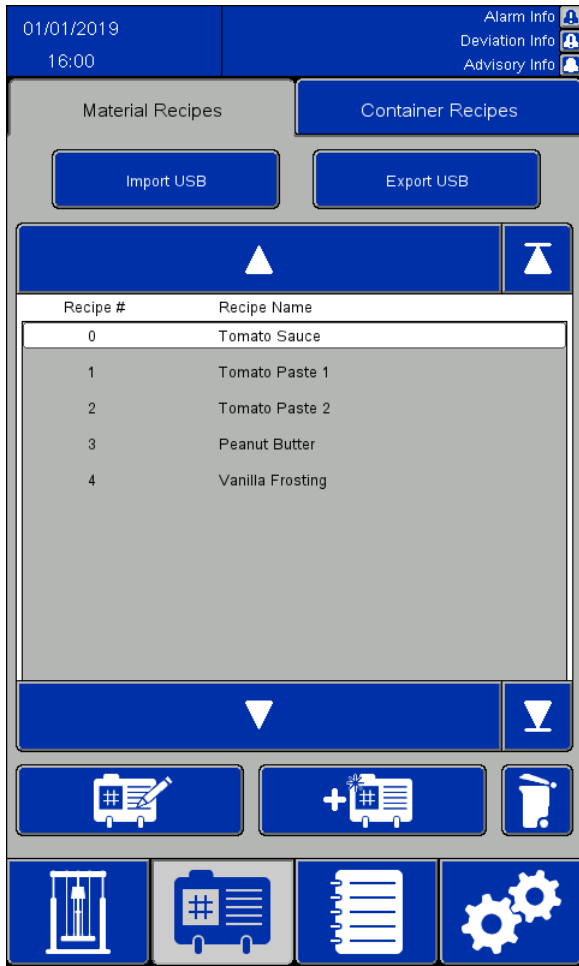

### **NOTES:**

- Recipes may use feedback from external devices to determine when a specific measure of product has been evacuated, so the system settings must be completed before any recipes are defined.
- All material recipes will need to select a container recipe, which defines the design of the drum. Define container recipes prior to defining material recipes.
- The units of measure defined in the system settings are reflected in the recipes. If the units of measure are changed, the values defined in the recipes will change to match the new unit of measure.

## Material Recipe Screen

Material Recipes can be exported to a USB device and viewed or edited on a PC, then imported back into the system. See [Import and Export with USB](#), page 61.



Icon/Field	Description
<b>Recipe #</b>	A numeric list of all available recipes. A maximum of 100 (0–99) recipes can be defined.
<b>Recipe Name</b>	User-defined alphanumeric name. The maximum number of characters allowed, including spaces, is 19.
	Move up the recipe list. Momentarily press to move up one recipe. Press and hold to continuously move up the recipe list until releasing the icon or reaching the top of the list.
	Move to the top of the defined recipe list.
	Move down the recipe list. Momentarily press to move down one recipe. Press and hold to continuously move down the recipe list until releasing the icon or reaching the bottom of the list.
	Move to the bottom of the defined recipe list.
	Edit recipe. Move the cursor to the desired recipe and press this icon. The Material Recipe edit screen is displayed.
	Add recipe. Press to define a new recipe. The Material Recipe edit screen is displayed. This will create a recipe with the lowest available recipe number. For example, if recipes 0–20 were defined and Recipe 3 was deleted since, adding a new recipe will result in a new Recipe 3. If 100 recipes have been defined, pressing this icon will select recipe 0 and move to the edit screen.
	Delete selected recipe. Select the desired recipe using the movement arrows and then press this icon to delete the selected recipe. <b>NOTE:</b> Recipe 0 cannot be deleted.
	<b>Import USB</b> Import the Material and Container Recipes from a USB device.
	<b>Export USB</b> Export the Material and Container Recipes to a USB device.

### Material Recipe Edit Screen

When creating a new recipe from scratch, default pressure settings are shown. These pressures are good starting points, but most pressure settings will have to be varied to obtain optimal performance for the specific application.

The viscosity of the product being pumped will require a different mix of pressure settings. If differing viscosities of the same product are pumped, a recipe with a defined viscosity can be copied and used as a template to define a new recipe for the additional viscosity. This creates a new recipe without needing to enter all new values. Only the values that must change need to be entered.

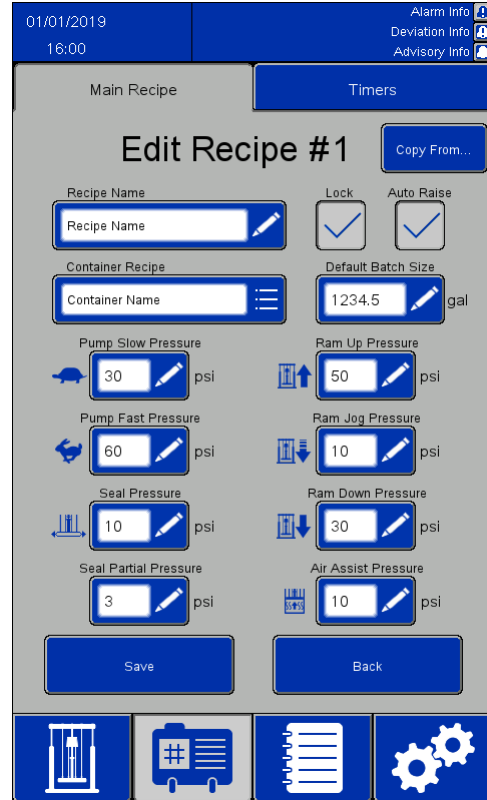

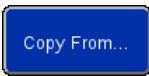

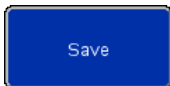
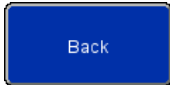

Icon/Field	Description
	Press to complete the fields of this recipe with the values assigned to another recipe. The copied values will overwrite any defined values in this recipe. After copying, individual fields can be modified to differentiate this recipe from the one copied. <b>NOTE:</b> Copying a locked recipe will also copy the password and save the new recipe as a locked recipe.
<b>Recipe Name</b>	User-defined alphanumeric field, 19 characters maximum.
<b>Lock</b>	When locked, the password defined on the System Settings page must be entered to edit the selected recipe. A locked recipe cannot have pressure settings changed on the Manual screen. <input type="checkbox"/> recipe not locked <input checked="" type="checkbox"/> recipe locked
<b>Auto Raise</b>	When checked, an automatic sequence will attempt to lift the ram plate out of the container and raise the ram to the top of its travel. If not checked, the ram plate will remain at the location where it is when an automatic sequence completes. If using batching and the drum is empty before the batch has completed, the ram plate will auto raise so that another drum can be placed and the run button pressed to resume the batch unload. <input type="checkbox"/> Auto Raise off <input checked="" type="checkbox"/> Auto Raise on
<b>Container Recipe</b>	Select from the list of user-defined container recipes.

*Electro-pneumatic Control Panel Display Screens*

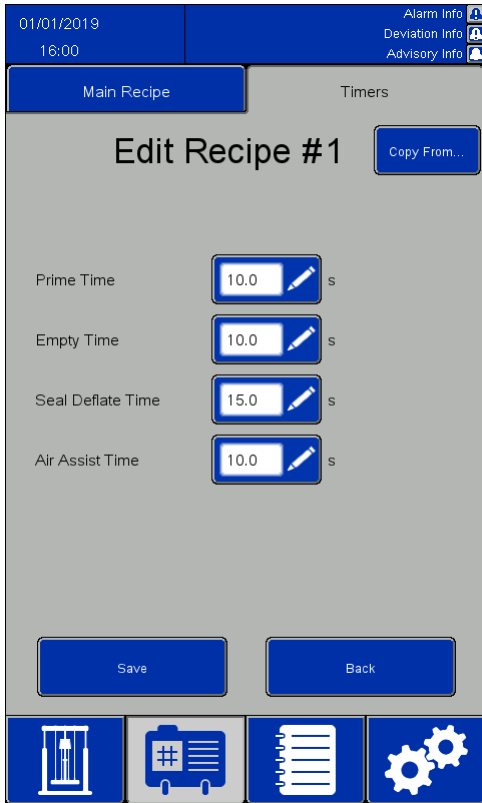
Icon/Field	Description
<b>Default Batch Size</b>	Select a value that is indicative of the normal size of a batch of the product being evacuated. The value can be larger than the contents of the container. In this case, one or more container changes may be required to complete the batch.
<b>Pump Slow Pressure</b>	Select the air pressure to be applied to the pump when running in Pump Slow Speed. Slow Speed runs automatically when loading a new container of material to prime the pump, and at the very end of an empty container.
<b>Pump Fast Pressure</b>	Select the air pressure to be applied to the pump when running in Pump Fast Speed. Fast Speed is run to evacuate the bulk of the material from the container.
<b>Air Assist Pressure</b>	Select the air pressure to be applied under the ram plate to aid in unsticking the ram plate from the material or the bottom of an empty drum.
<b>Seal Pressure</b>	Select the air pressure to be applied to the seal while inside the container. Always choose the lowest pressure that achieves the desired result. Too much pressure reduces the life of the seal and creates excessive frictional force opposing movement of the ram. Too little force may cause material to leak past the seal.
<b>Ram Up Pressure</b>	Select the air pressure to lift the ram ram plate out of the container. Choose the lowest pressure that raises the ram without lifting the container.
<b>Ram Down Pressure</b>	Select the air pressure to push the ram down against the product during evacuation. Always use the lowest pressure that achieves the desired result. Too much down pressure will cause material leakage around the inflatable seal.
<b>Ram Jog Pressure</b>	Select the air pressure to be applied to the ram when jogging downward.
<b>Seal Partial Pressure</b>	Select the air pressure to be applied to the inflatable seal when the ram plate is approaching an overfull container. Choose the lowest pressure that achieves the desired result. Setting Seal Partial Pressure too high can cause inflatable seal damage during entry into the container.
	Save the current values displayed. If this screen is exited without saving, any changes made to the screen are lost.
	Return to the recipe list screen. If this screen is exited without saving, any changes made to the screen are lost.

### Material Recipe Timers Screen

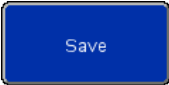







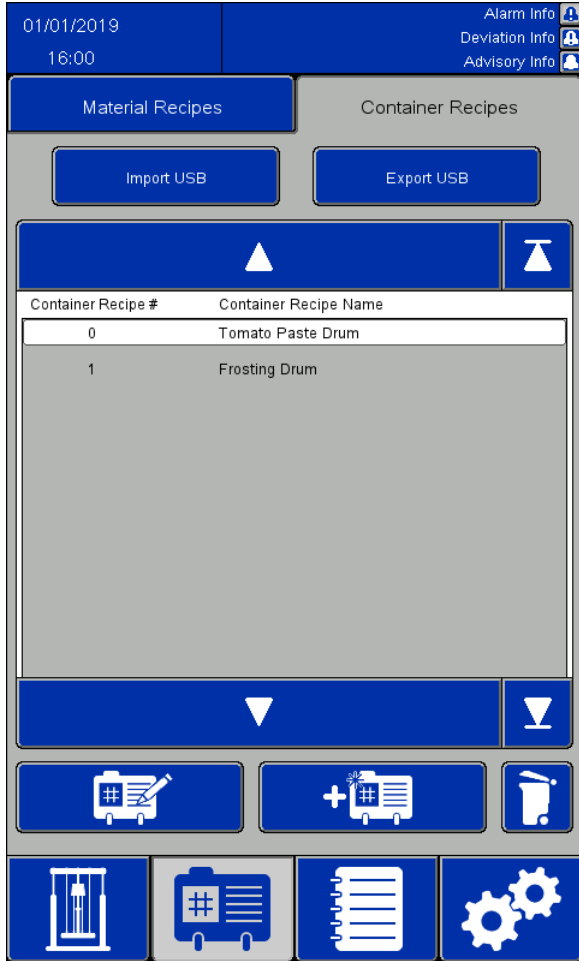

Icon/Field	Description
	Press to complete the fields of this recipe with the values assigned to another recipe. The copied values will overwrite any defined values in this recipe. After copying, individual fields can be modified to differentiate this recipe from the one copied. <b>NOTE:</b> Copying a locked recipe will also copy the password and save the new recipe as a locked recipe.
<b>Prime Time</b>	Length of time, in seconds, to attempt to achieve a prime of the pump with the product in the drum. The pump will operate at the slow speed until the amount of time specified by this field has elapsed. The pump will then operate at the fast speed.
<b>Empty Time</b>	When the ram assembly reaches the empty position, the pump will then operate for the amount of time entered in this field. Once this time has elapsed, the pump will stop or raise if Auto Raise is checked.
<b>Seal Deflate Time</b>	Length of time, in seconds, to deflate the ram plate seal.
<b>Air Assist Time</b>	<i>This value is not used in the current software version. It does not affect system operation.</i>
	Save the current values displayed. If this screen is exited without saving, any changes made to the screen are lost.
	Return to the recipe list screen. If this screen is exited without saving, any changes made to the screen are lost.

### Container Recipe Screen

Container Recipes can be exported to a USB device and viewed or edited on a PC, then imported back into the system. See [Import and Export with USB, page 61](#).





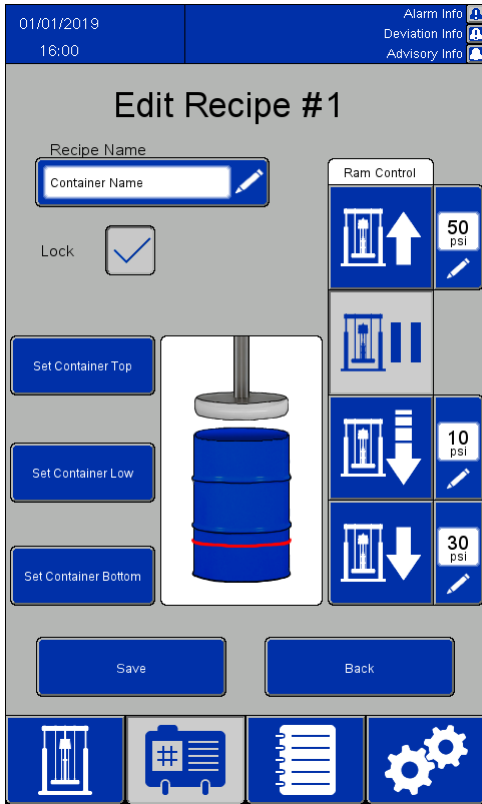

Icon/Field	Description
<b>Recipe #</b>	A numeric list of all available recipes. A maximum of 20 (0–19) recipes can be defined.
<b>Recipe Name</b>	User-defined alphanumeric name. The maximum number of characters allowed, including spaces, is 19.
	Move up the recipe list. Momentarily press to move up one recipe. Press and hold to continuously move up the recipe list until releasing the icon or reaching the top of the list.
	Move to the top of the defined recipe list.
	Move down the recipe list. Momentarily press to move down one recipe. Press and hold to continuously move down the recipe list until releasing the icon or reaching the bottom of the list.
	Move to the bottom of the defined recipe list.
	Edit recipe. Move the cursor to the desired recipe and press this icon. The Container Recipe edit screen is displayed.
	Add recipe. Press to define a new recipe. The Container Recipe edit screen is displayed. This will create a recipe with the lowest available recipe number. For example, if recipes 0–10 were defined and Recipe 3 was deleted since, adding a new recipe will result in a new Recipe 3. If 20 recipes have been defined, pressing this icon will select recipe 0 and move to the edit screen.
	Delete selected recipe. Select the desired recipe using the movement arrows and then press this icon to delete the selected recipe. <b>NOTE:</b> Recipe 0 cannot be deleted.
	<b>Import USB</b> Import the Material and Container Recipes from a USB device.
	<b>Export USB</b> Export the Material and Container Recipes to a USB device.

## Container Recipe Edit Screen

An empty drum is required for defining the container recipe.

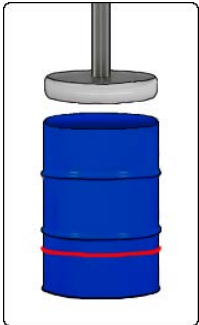
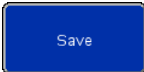
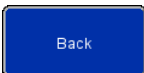

Icon/Field	Description
<b>Recipe Name</b>	User-defined alphanumeric field, 19 characters maximum.
<b>Lock</b>	When locked, the password defined on the System Settings page must be entered to edit the selected recipe. <input type="checkbox"/> recipe not locked <input checked="" type="checkbox"/> recipe locked
	Numeric displays next to the icons are the pressure settings defined in the current recipe. Changes entered here are not saved to the recipe. A locked recipe will not allow changing these settings.
<b>Ram Control</b>	
	<b>Ram Up</b> Momentarily press to raise the ram assembly. The ram will continue raising until the ram has reached the top of its travel, unless manually stopped.
	<b>Ram Hold</b> Momentarily press to keep the ram at the current location. <b>NOTE:</b> This is an active hold and the system may momentarily energize Ram Up to keep the ram plate from drifting. Active hold is enabled for 5 seconds after any Pump, Ram, Seal, or Air Assist command.

Icon/Field	Description
	<p><b>Ram Jog</b> Press and hold to lower the ram assembly. Releasing the button will stop lowering the ram.</p>
	<p><b>Ram Down</b> Momentarily press to lower the ram to the lowest position. The ram will continue lowering until the ram has reached the bottom of its travel, unless manually stopped.</p>
<p><b>Set Container Top</b></p>	<p>Position the drum and use the manual controls to lower the ram plate into the drum until the top lip of the ram plate is at the same height as the top lip of the drum. Press the Set Container Top icon to store the position.</p>
<p><b>Set Container Low</b></p>	<p>Lower the ram plate into the drum until the ram plate is at the height where the material in the drum is at a low level. Press the Set Container Low icon to store the position. This setting will control when the pump goes from fast pumping to slow pumping to finish evacuating the remaining product from the drum.</p>
<p><b>Set Container Bottom</b></p>	<p>Lower the ram plate into the drum until the ram plate is at the bottom of the drum. Press the Set Container Bottom icon to store the position. This setting will instruct the pump to stop pumping, deflate the seal, and raise the ram plate if the auto raise function has been selected.</p>
	<p>This is a visual presentation of the ram plate position settings for this container recipe. It will reflect the positions that have been saved for this recipe. If the value of a setting has not yet been defined, the position of the ram plate, low level, or bottom of drum indications may not be shown in the desired position on the graphic. The red line indicates the location of the current low level position.</p>
	<p>Save the current values displayed. If this screen is exited without saving, any changes made to the screen are lost.</p>
	<p>Return to the recipe list screen. If this screen is exited without saving, any changes made to the screen are lost.</p>



## Event Log

Events are Alarms, Deviations, Advisories, and Records detected by the system. They are logged to assist in troubleshooting the system. Alarms will cause the unloader to cease operation when they are detected. A user will need to clear the alarm and restart the unloader.

Event Logs can be exported to a USB device and viewed on a PC. See [Import and Export with USB, page 61](#).

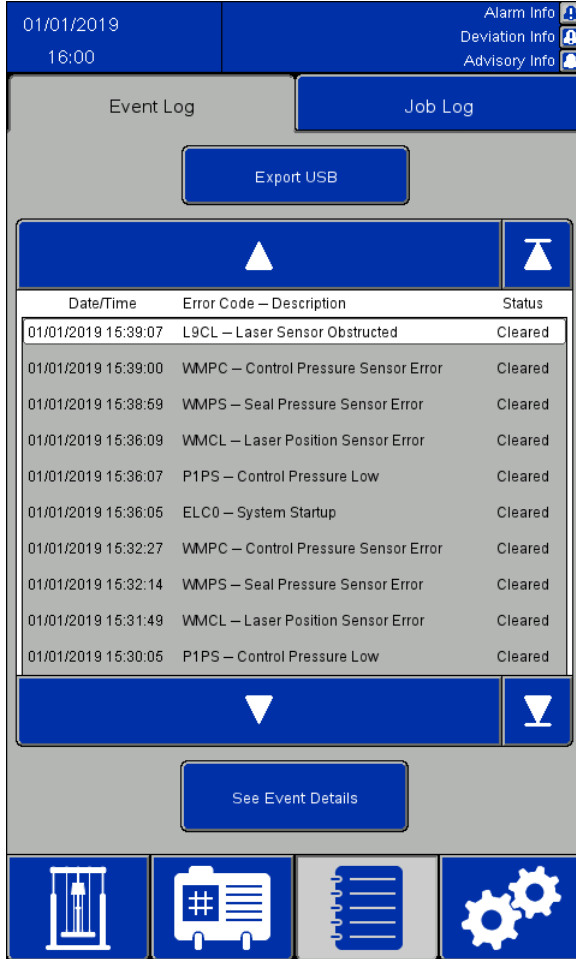

Icon/Field	Description
	Move up the list. Momentarily press to move up one entry. Press and hold to continuously move up the list until releasing the icon or reaching the top of the list.
	Move to the top of the defined list.
	Move down the list. Momentarily press to move down one entry. Press and hold to continuously move down the list until releasing the icon or reaching the bottom of the list.
	Move to the bottom of the defined list.
	<b>See Event Details</b> Press to see the details for the selected event.
	<b>Export USB</b> Press to export the Event Log to a USB device.

Alarm Details

Triggered:	Acknowledged:	Cleared:
01/01/2019 12:00:00	01/01/2019 12:01:00	01/01/2019 12:01:30

Error Code: V1CE -- E-stop or I/O Power Error

I/O has lost power. Ensure the Emergency Stop button is not depressed. If problem persists, see the user manual for troubleshooting.

Back

**ELECTRIC SHOCK HAZARD**

To reduce the risk of electric shock when accessing the electrical enclosure while power is present:

- All electrical work must be done by a qualified electrician.
- Wear appropriate personal protective equipment.

Event Type	Event Description	Error Code	Cause	Fix
Alarm	Communication bus power error	V1CC	Communication bus has lost power	Restore power to communication bus
Alarm	Control panel supply pressure low	P1PS	Control supply pressure sensor reads pressure less than the minimum 30 psi required for operation or less than 5 psi below largest pressure required by the current recipe	Increase supply air pressure or reduce pressure required by the current recipe
Alarm	Control supply pressure sensor error	WMPC	Control supply pressure sensor reports an error	Check control supply pressure sensor and wiring
Alarm	Emergency stop or I/O power error	V1CE	I/O has lost power	Restore I/O power, reset E-stop button
Alarm	External interlock #1 open	EBN1	Interlock #1 is enabled and tripped	Close or disable interlock #1
Alarm	External interlock #2 open	EBN2	Interlock #2 is enabled and tripped	Close or disable interlock #2
Alarm	Laser position sensor error	WMCL	Laser sensor reports an error	Check Laser sensor and wiring
Alarm	Laser sensor obstructed	L9CL	An obstruction or unintended target of the position sensor has been detected	Ensure the laser has a clear line of sight to the target
Alarm	Network Communication Error	CC0R	Remote network communication is enabled, but the remote device cannot be found	Verify that the IP addresses of the system and the remote controller are correct. Verify that the system and the remote controller are on the same network. Verify that the remote controller is properly configured as described in <a href="#">Network, page 52</a> .

*Electro-pneumatic Control Panel Display Screens*

<b>Event Type</b>	<b>Event Description</b>	<b>Error Code</b>	<b>Cause</b>	<b>Fix</b>
Alarm	Network Initialization Error	CA0R	An error occurred while initializing the system for network communication	Restart the system. Contact Graco Support if the problem persists.
Alarm	Network Interlock Open	EB0R	The network interlock is tripped	Ensure proper output from the remote controller or disable the remote connection.
Alarm	Pump supply pressure low	P1PP	Pump supply pressure sensor reads pressure more than 5 psi below the pressure being driven	Increase supply air pressure or reduce pressure required by the current recipe
Alarm	Pump supply pressure sensor error	WMPP	Pump supply pressure sensor reports an error	Check pump supply pressure sensor and wiring
Alarm	Ram movement timeout	EU1R	Upward ram movement has not reached the minimum height when the ram movement timeout completes	Check ram for obstructions to movement, manually raise ram
Alarm	Seal inflation timeout	EU1S	Seal has not inflated to within 1.0 psi of the value being driven when the seal inflation timeout completes	Check seal and air lines
Alarm	Seal not deflated	P71S	Seal pressure sensor does not read the seal is depressurized after seal deflation timeout completes	Check seal, manually deflate seal, adjust Seal Deflate Time in recipe
Alarm	Seal pressure sensor error	WMPS	Seal pressure sensor reports an error	Check seal pressure sensor and wiring
Alarm	Software Error	WX00	Unexpected state detected in the software	Acknowledge the alarm. If the alarm is triggered regularly, contact Graco
Alarm	X20AO2622 analog output module error	WMCA	X20AO2622 module reports an error	Check X20AO2622 module and wiring. Verify that the modules are installed in the proper locations*.
Alarm	X20BC1083 bus coupler module error	WMCB	X20BC1083 module reports an error	Check X20BC1083 module and wiring. Verify that the modules are installed in the proper locations*.
Alarm	X20CM8281 mixed module error	WMCC	X20CM8281 module reports an error	Check X20CM8281 module and wiring. Verify that the modules are installed in the proper locations*.
Alarm	X20DO8322 digital output module error	WMCD	X20DO8322 module reports an error	Check X20DO8322 module and wiring. Verify that the modules are installed in the proper locations*.
Alarm	X20DS438A IO-LINK module error	WMCS	X20DS438A module reports an error	Check X20DS438A module and wiring. Verify that the modules are installed in the proper locations*.
Alarm	X20PS9400 power supply module error	WMCP	X20PS9400 module reports an error	Check X20PS9400 module and wiring. Verify that the modules are installed in the proper locations*.
Deviation	File not found	WSU0	The file targeted by a USB Import could not be found.	Verify the file name is correct (has not been changed from the name given during a USB export) and that it is located within a directory named "SDU-[serial number]".
Deviation	Position sensor dirty	L2CL	Position sensor reflectivity value is low.	Ensure the laser sensor and target are clear of debris.

*Electro-pneumatic Control Panel Display Screens*

<b>Event Type</b>	<b>Event Description</b>	<b>Error Code</b>	<b>Cause</b>	<b>Fix</b>
Deviation	USB data format error	WSU2	The data in the file targeted by a USB import contains incorrectly formatted data.	Verify data is formatted correctly. No commas or new lines should be inserted while modifying a file for importing into the system.
Deviation	USB file header error	WSU1	The information in the header of the file targeted by a USB import contains an incorrect or incorrectly formatted Software Part Number or Software Version.	Verify Software Part Number and Software Version and correct and formatted correctly in the file header.
Deviation	USB not connected	CCU0	A USB device is not connected to the system.	Verify the USB device is compatible with the system, formatted properly, and inserted fully into one of the USB ports on the back of the screen unit. A USB device can take up to 10 seconds to be recognized by the system once inserted.
Deviation	USB operation failed	WXU0	A USB import or export command was not able to be completed: an unspecified error occurred during the operation.	Check that the USB device is fully inserted into the USB ports on the back of the screen unit. If importing, check formatting of data in files and remove any unnecessary files from the directory.
Advisory	USB Export Successful	EQUE	USB Export operation completed successfully.	N/A
Advisory	USB Import Successful	EQUI	USB Import operation completed successfully.	N/A
Record	System Depressurization	P010	A depressurization sequence was completed.	N/A
Record	System Startup	ELC0	The system started up and the boot sequence completed.	N/A
Record	System Time Changed	ECT0	The system time was changed by more than one minute.	N/A

\* Modules must be installed in the following order, from left to right:

- X20BC1083
- X20PS9400
- X20CM8281
- X20DS438A
- X20AO2622
- X20DO8322

## Job Log

The Job Log screen displays a historical log of jobs completed by the system. Pressing the Job Complete button on the Automatic or Manual run screens will automatically snapshot recipe settings and information about the dispensed material, assign a Job Number, and log it here. A Job Name of up to 39 characters can be assigned to a job on the Automatic run screen to differentiate it from other job logs easily. The Job Name must be entered before pressing the Job Complete button.

Job Logs can be exported to a USB device and viewed on a PC. See [Import and Export with USB](#), page 61.

The screenshot shows the Job Log screen with the following elements:

- Top status bar: 01/01/2019 16:00, Alarm Info, Deviation Info, Advisory Info.
- Navigation tabs: Event Log, Job Log.
- Export USB button.
- Table with columns: Date/Time, Job#, R#, Job Name, Amount.
- Navigation buttons: Up arrow, Home arrow, Down arrow, Bottom arrow.
- See Job Details button.
- Bottom menu bar with icons for Home, Job Log, List, and Settings.

Date/Time	Job#	R#	Job Name	Amount
01/01/2019 15:27:39	209	1	Pizza Sauce	120 gal
01/01/2019 14:54:22	208	1	Pizza Sauce	120 gal
01/01/2019 14:01:41	207	1	Pizza Sauce	123 gal
01/01/2019 13:38:16	206	1	Pizza Sauce	122 gal
01/01/2019 11:51:26	205	2	Ketchup	180 gal
01/01/2019 11:02:08	204	2	Ketchup	182 gal
01/01/2019 10:11:46	203	2	Ketchup	180 gal
01/01/2019 09:45:01	202	2	Ketchup	180 gal
01/01/2019 08:58:35	201	2	Ketchup	181 gal
01/01/2019 08:25:10	200	2	Ketchup	183 gal

Icon/Field	Description
	Move up the list. Momentarily press to move up one entry. Press and hold to continuously move up the list until releasing the icon or reaching the top of the list.
	Move to the top of the defined list.
	Move down the list. Momentarily press to move down one entry. Press and hold to continuously move down the list until releasing the icon or reaching the bottom of the list.
	Move to the bottom of the defined list.
	<b>See Job Details</b> Press to see the details for the selected job.
	<b>Export USB</b> Press to export the Job Log to a USB device.

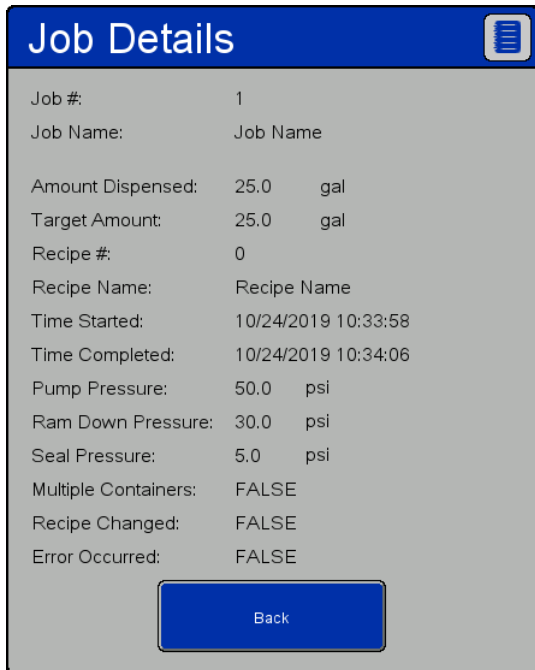

The screenshot shows a 'Job Details' screen with a blue header and a grey background. The data is as follows:

Job #:	1
Job Name:	Job Name
Amount Dispensed:	25.0 gal
Target Amount:	25.0 gal
Recipe #:	0
Recipe Name:	Recipe Name
Time Started:	10/24/2019 10:33:58
Time Completed:	10/24/2019 10:34:06
Pump Pressure:	50.0 psi
Ram Down Pressure:	30.0 psi
Seal Pressure:	5.0 psi
Multiple Containers:	FALSE
Recipe Changed:	FALSE
Error Occurred:	FALSE

At the bottom center, there is a blue button labeled 'Back'.

A Job Log contains the following information:

- Job Number
- Job Name
- Amount Dispensed
- Target Amount for batching
- Recipe Number used for the job
- Name of recipe used for the job
- The time the job was started
- The time the job completed
- Pump pressure of the recipe
- Ram Down pressure of the recipe
- Seal pressure of the recipe
- A "Multiple Containers" indicator that is TRUE if a sequence empties the first container it was evacuating from. Otherwise it is FALSE.
- A "Recipe Changed" indicator that is TRUE if the active material recipe is changed, if the recipe pressures are changed on the Manual run screen, or if any values for the active recipe are edited on the Material Recipe Edit screen and saved. Otherwise it is FALSE.
- An "Error Occurred" indicator that is TRUE if an alarm or deviation occurs while the job is active. Otherwise it is FALSE.

## System Configuration Screen

The system configuration screen defines the SDU parameters. The system settings can be exported to a USB device and viewed or edited on a PC, then imported back into the system. See [Import and Export with USB](#), page 61.

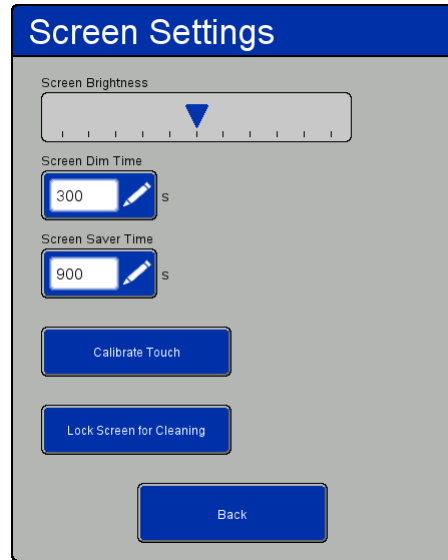
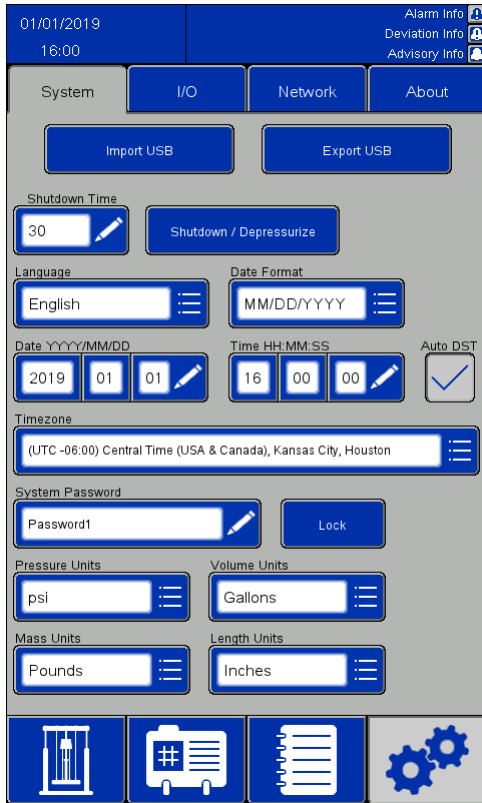



Icon/Field	Description
	<b>Import USB</b> Import the system settings from a USB device.
	<b>Export USB</b> Export the system settings to a USB device.
	<b>Shutdown/Depressurize</b> Press to vent pressure from the system. If the ram is raised and not locked or held in place, it will move down as venting occurs. When done, an acknowledge message appears and requires user response.
	<b>Shutdown Time</b> Shutdown Time, in seconds. Enter the amount of time to allow for system depressurization. If the system has not been depressurized by the time the specified time has elapsed, an alarm will be generated.
	<b>Screen Settings</b> Press to show the screen settings window. Use the window to set the screen brightness, dim time, screen saver time, touch calibration, and briefly block touches to clean the touch screen.

*Electro-pneumatic Control Panel Display Screens*

Icon/Field	Description
	<p><b>Lock</b> If a password has been set, press the Lock button to immediately lock all settings from being edited. Enter the password to unlock the settings. The system will automatically lock after two minutes if a password is set and the user leaves the settings menu without pressing Lock.</p>
<b>Language</b>	Select the desired language.
<b>Date Format</b>	Select the desired date format.
<b>Date</b>	Enter the current date.
<b>Time</b>	Enter the current time.
<b>Auto DST</b>	Check to enable automatic time adjustments for daylight savings time.
<b>Timezone</b>	Select the desired timezone. The system time will need to be set after switching timezones.
<b>Password</b>	Enter the desired password to be used to access the control box display screens. Verify the accuracy of the entry prior to selecting the keyboard return key. <b>NOTE:</b> This field is case-sensitive.
<b>Pressure Units</b>	Select between PSI, MPa, or bar.
<b>Mass Units</b>	Select between pounds and kilograms.
<b>Volume Units</b>	Select between gallons, cubic feet, liters, or cubic meters.
<b>Length Units</b>	Select between inches and centimeters.



## Feedback Control Screen

			
<p>To reduce the risk of injury due to electric shock, remove power to the control panel before entering the control panel to make connections for measurement devices.</p>			

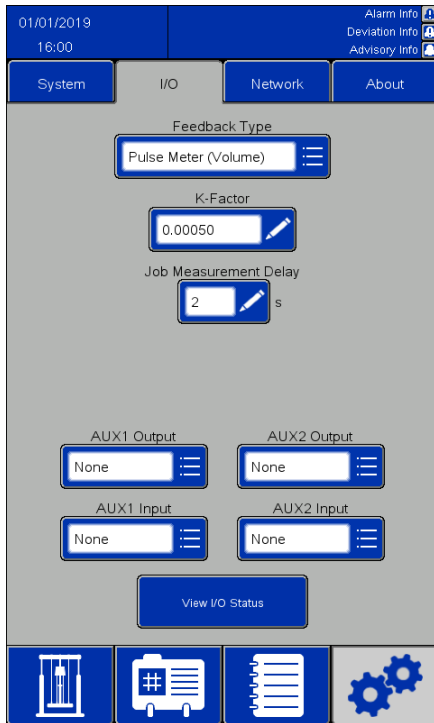

Selecting pulse feedback

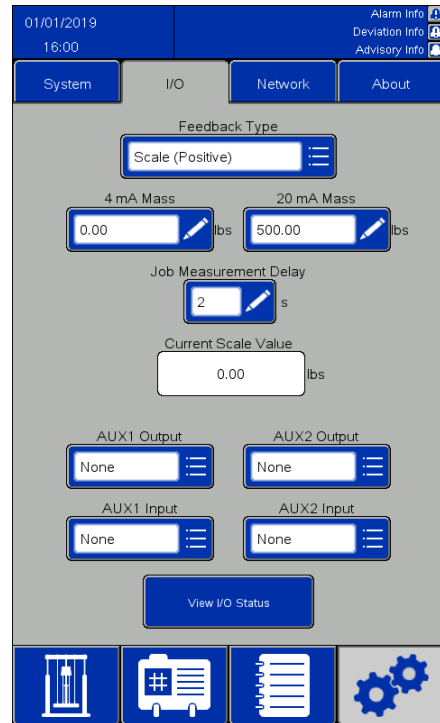

Selecting scale feedback

Icon/Field	Description
<b>Feedback Type</b>	<p>Select feedback type:</p> <ul style="list-style-type: none"> <li>None: No feedback enabled.</li> <li>Pulse Meter (Volume): A pulse meter measuring volume dispensed must be connected to CM8281-12 to use this feedback type (20 kHz max).</li> <li>Pulse Meter (Mass): A pulse meter measuring mass dispensed must be connected to CM8281-12 to use this feedback type (20 kHz max).</li> <li>Scale (Positive): A scale measuring weight is connected; weight is increasing as material is dispensed.</li> <li>Scale (Negative): A scale measuring weight is connected; weight is decreasing as material is dispensed. This input is used if the SDU system is mounted on a scale.</li> </ul>
<b>K-Factor*</b>	This field appears if a pulse meter type input is selected. Set the unit value a single pulse represents.
<b>20 mA Mass**</b>	This field appears if a scale type input is selected. Set the weight associated with the 20 mA signal input in this field.
<b>4 mA Mass**</b>	This field appears if a scale type input is selected. Set the weight associated with the 4 mA signal input in this field.

*Electro-pneumatic Control Panel Display Screens*

<b>Icon/Field</b>	<b>Description</b>
<b>Aux 1 Input</b>	<p>CM8281–11 Input Voltage Asserted: &gt;16 VDC. Not Asserted: &lt;5 VDC Select input type:</p> <ul style="list-style-type: none"> <li>• None: Not monitored.</li> <li>• Start/Stop: See <a href="#">Remote Operation, page 30</a>.</li> <li>• Ready Interlock: The system will Alarm if Not Asserted.</li> <li>• Job Complete: The system will complete and log a job if Asserted, provided there has been some amount of material dispensed.</li> </ul>
<b>Aux 2 Input</b>	<p>CM8281–21 Input Voltage Asserted: &gt;16 VDC. Not Asserted: &lt;5 VDC Select input type:</p> <ul style="list-style-type: none"> <li>• None: Not monitored.</li> <li>• Start/Stop: See <a href="#">Remote Operation, page 30</a>.</li> <li>• Ready Interlock: The system will Alarm if Not Asserted.</li> <li>• Job Complete: The system will complete and log a job if Asserted, provided there has been some amount of material dispensed.</li> </ul>
<b>Aux1 Output</b>	<p>CM8281–13 Output Voltage Asserted: 24 VDC. Not Asserted: 0 VDC Select output type:</p> <ul style="list-style-type: none"> <li>• None: Not monitored.</li> <li>• System OK: Asserted while no Alarms are active.</li> <li>• Pump Run: Asserted while the pumps are running.</li> <li>• Sequence Complete: Asserted after an Automatic or Batching sequence has completed.</li> <li>• Container Low: Asserted when the system is below the “Container Low” point during operation.</li> <li>• Container Empty: Asserted when the system has emptied the container during operation.</li> </ul>
<b>Aux2 Output</b>	<p>CM8281–23 Output Voltage Asserted: 24 VDC. Not Asserted: 0 VDC Select output type:</p> <ul style="list-style-type: none"> <li>• None: Not monitored.</li> <li>• System OK: Asserted while no Alarms are active.</li> <li>• Pump Run: Asserted while the pumps are running.</li> <li>• Sequence Complete: Asserted after an Automatic or Batching sequence has completed.</li> <li>• Container Low: Asserted when the system is below the “Container Low” point during operation.</li> <li>• Container Empty: Asserted when the system has emptied the container during operation.</li> </ul>
<b>Job Measurement Delay</b>	<p>Delay after a batch is completed, during which the amount pumped is still recorded. Default is 2 seconds, but may be set up to 5 seconds.</p>
<b>Current Scale Value</b>	<p>Displays the current read value from the scale.</p>

\* See [Setting K-Factor, page 51](#) for more information.

\*\* See [Setting Scale Feedback, page 51](#) for more information.

## Setting K-Factor

In order for a batching cycle to accurately measure product, the K-Factor must be appropriately set and the system outlet fluid lines fully loaded.

A calibration routine can be run to validate/adjust the K-Factor setting.

1. Complete the current Job to reset the batch amount.
2. Dispense desired test amount of material.
3. Validate the actual amount of material dispensed (volume or mass).
4. Calculate and enter the new K-Factor:

$$\{\text{New K-Factor}\} = \{\text{Old K-Factor}\} \times \frac{\{\text{actual dispensed amount}\}}{\{\text{job dispensed amount}\}}$$

**NOTE:** If using “Pulse Meter (Mass)” and the product density changes, the K-Factor value must be re-calibrated. Otherwise, the batch may not be accurate.

## Setting Scale Feedback



In order for a batching cycle to accurately measure product, the 4 mA Mass and 20 mA Mass settings for the Scale (Positive) or Scale (Negative) must be set appropriately.

- 4 mA Mass: Set this value to the actual weight of the product setting on the scale (including the container) when the output of the scale is 4 mA.
- 20 mA Mass: Set this value to the actual weight of the product setting on the scale (including the container) when the output of the scale is 20 mA.

Although the unloader system only uses differences in weights during batching, it is important to use the same container when setting 4 mA Mass and 20 mA Mass values. After the values are set, the actual weight of the container is not important.

**NOTE:** If product density changes, the 4 mA Mass and 20 mA Mass values must be re-set. Otherwise the batch may not be accurate.

## Network

				
<p>To reduce the risk of injury due to electric shock, remove power to the control panel before entering the control panel to make connections for measurement devices.</p>				

The Network page is used to configure the SDU for network communication.

Currently, the system is only configured to communicate through Ethernet/IP (EIP) protocol to a remote programmable logic controller (PLC). Contact Graco Customer Support for information regarding network communication protocols.

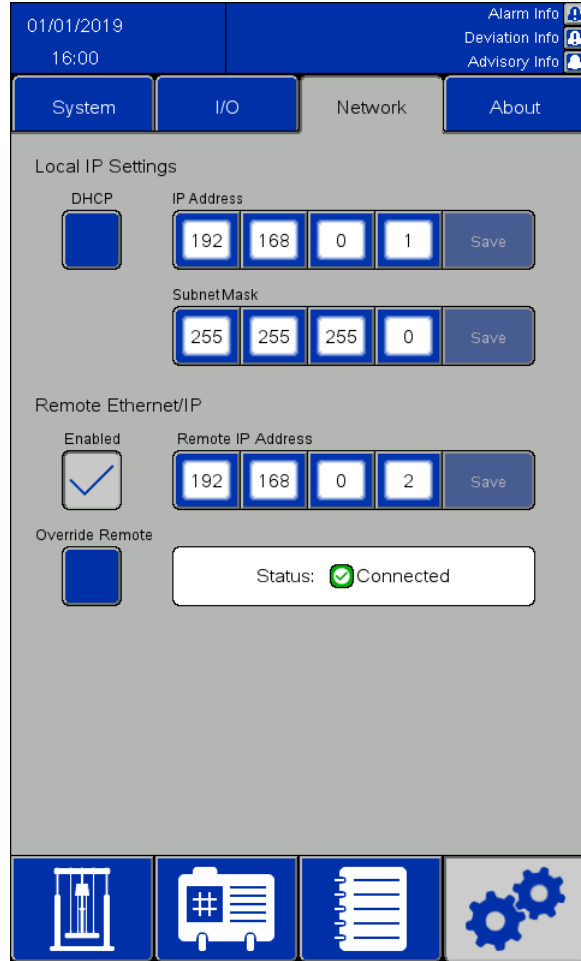

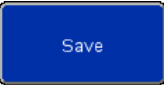
Icon/Field	Description
<b>DHCP</b>	Check to enable Dynamic Host Configuration Protocol for the network connection.
<b>IP Address</b>	The current IP Address of the system is displayed here. If DHCP is disabled, these fields become editable to enter a static IP address.
<b>Subnet Mask</b>	The current Subnet Mask utilized by the system is displayed here. If DHCP is disabled, these fields become editable to enter a Subnet Mask.
<b>Enable Ethernet/IP</b>	Check to enable EIP network communication.
<b>Remote IP Address</b>	Enter the IP Address of the remote PLC for the system to talk to.
	<b>Save</b> The Save button will be active if the IP Address, Subnet Mask, or the Remote IP Address have been edited. Press the Save button to save the edited value before leaving the Network screen. Changes may be lost if the Save button is not pressed. If network communication is enabled, restart the system to resume network communication after saving a value in the Network settings.
<b>Override Remote</b>	Check to stop reading values driven by the remote PLC into the system. If a sequence is running, select the Override Remote box to stop the sequence and put the system in standby.
<b>Ethernet/IP Status</b>	Shows if the active communication is connected or disconnected from the remote PLC.

## Ethernet/IP

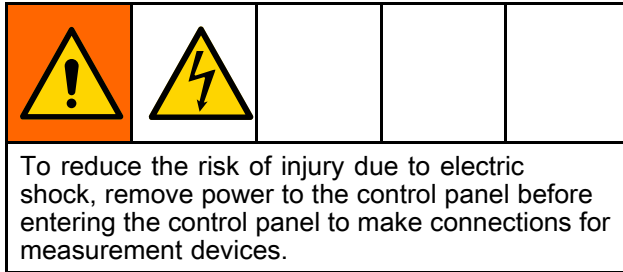

A network cable is required to use Ethernet/IP communication with a remote Allen-Bradley PLC. Insert the network cable into the IF2 port on the back side of the screen unit.

**NOTE:** The minimum Requested Packet Interval (RPI) for this interface is 20 milliseconds.

**NOTE:** The Ethernet/IP interface uses implicit messaging. One variable bank is for inputs, and one variable bank is for outputs.

### Connect a Remote PLC

Contact Graco Customer Support to obtain a configuration file with the .L5K file extension needed for this procedure. Then, follow this procedure to configure the remote PLC to communicate with the control panel.

**NOTE:** These instructions are for configuring an Allen-Bradley PLC using the Studio 5000 software.

1. Import the .L5K file into Studio 5000 to create a new Studio 5000 project.
 

**NOTE:** Contact Graco Customer Support to obtain a configuration file with the .L5K file extension.
2. Export the following settings from the project:
  - a. The controller tags
  - b. The “CopyEthIP” program (located under Tasks)
  - c. The “AssemblnType” and “AssembOutType” data types (located under User-Defined Data Types)
3. Open the run-time project, where the settings from Step 2 will be imported.

4. In the run-time Studio 5000 project, create the Ethernet/IP communication module.
  - a. Under Ethernet, select ETHERNET-MODULE to create a new generic Ethernet module.
  - b. Configure the module exactly as the ETHERNET-MODULE is configured in the project with the imported .L5K file, except for the IP Address. Enter the IP Address assigned to the SDU system.
  - c. After creating the module, set the RPI to a minimum of 20 milliseconds in the Connection Properties.
5. Right-click on User-Defined Data Types and import the “AssemblnType” and “AssembOutType” data types.
6. Import the controller tags: Select *Tools > Import > Tags and Logic Comments*.
 

This will create EthIP\_In and EthIP\_Out data types in the controller tags with all variables named in the Variable Interface List.
7. Right-click on the Main Task and import the CopyEthIP program. Once the CopyEthIP program is done importing, the configuration for the Ethernet/IP communication with the Allen-Bradley PLC will be complete. Modify the program as needed within bounds of the protocol.
8. For remote communication, configure the IP Address, Subnet Mask, and the Remote IP Address on the Network page of the SDU. See [Network, page 52](#).
9. Enable the Ethernet/IP communication on the SDU system.
 

**NOTE:** Restart the SDU to initiate communication between the PLC and the SDU.

### Variable Interface List

Allen-Bradley PLC variables are prepended with the following naming structures:

Input: BR2AB\_  
Output: AB2BR\_

**NOTE:** All output variables correspond to a variable on the input interface. The output variables are sent back from the SDU so that the remote PLC can verify that the sent value was seen by the SDU system.

**NOTE:** The SDU must be told which variables to read from the Allen-Bradley PLC. Set the AB2BR\_networkOverwriteBitfield variable appropriately to control the SDU system remotely.

Outputs from the Allen-Bradley Controller			
Variable Name	Data Type	Possible Values	Notes
AB2BR_evnt_acknowledge	BOOL	TRUE, FALSE	Sensitive to rising edge. Acknowledges the active alarm in the SDU system.
AB2BR_networkInterlock	BOOL	TRUE, FALSE	System will not operate if remote connection is active and AB2BR_networkInterlock is FALSE
AB2BR_pumpStartStop	BOOL	TRUE (Evacuate), FALSE (Stop evacuation)	See <a href="#">Remote Operation, page 30</a> .
AB2BR_jobComplete	BOOL	TRUE, FALSE	Sensitive to rising edge. Completes the current job and logs it to the SDU system.
AB2BR_rec_loadRecipe	BOOL	TRUE, FALSE	Sensitive to rising edge. To load a different recipe, ensure the other recipe exists in the system, set AB2BR_rec_recipeNumber, and set the AB2BR_rec_loadRecipe variable to TRUE.
AB2BR_rec_recipeNumber	SINT	SINT	Corresponds to bit 0 in the AB2BR_networkOverwriteBitfield variable.
AB2BR_rec_autoRaise	BOOL	TRUE, FALSE	Corresponds to bit 1 in the AB2BR_networkOverwriteBitfield variable.
AB2BR_rec_pumpSlowPressure_psi	REAL	REAL	Corresponds to bit 2 in the AB2BR_networkOverwriteBitfield variable. Units in psi.
AB2BR_rec_pumpFastPressure_psi	REAL	REAL	Corresponds to bit 3 in the AB2BR_networkOverwriteBitfield variable. Units in psi.
AB2BR_rec_ramUpPressure_psi	REAL	REAL	Corresponds to bit 4 in the AB2BR_networkOverwriteBitfield variable. Units in psi.
AB2BR_rec_ramDownPressure_psi	REAL	REAL	Corresponds to bit 5 in the AB2BR_networkOverwriteBitfield variable. Units in psi.
AB2BR_rec_ramJogPressure_psi	REAL	REAL	Corresponds to bit 6 in the AB2BR_networkOverwriteBitfield variable. Units in psi.
AB2BR_rec_sealFullPressure_psi	REAL	REAL	Corresponds to bit 7 in the AB2BR_networkOverwriteBitfield variable. Units in psi.
AB2BR_rec_sealPartPressure_psi	REAL	REAL	Corresponds to bit 8 in the AB2BR_networkOverwriteBitfield variable. Units in psi.
AB2BR_rec_airAssistPressure_psi	REAL	REAL	Corresponds to bit 9 in the AB2BR_networkOverwriteBitfield variable. Units in psi.

<b>Outputs from the Allen-Bradley Controller</b>			
<b>Variable Name</b>	<b>Data Type</b>	<b>Possible Values</b>	<b>Notes</b>
AB2BR_rec_primeTime_s	INT	INT	Corresponds to bit 10 in the AB2BR_networkOverwriteBitfield variable. Units in seconds.
AB2BR_rec_emptyTime_s	INT	INT	Corresponds to bit 11 in the AB2BR_networkOverwriteBitfield variable. Units in seconds.
AB2BR_rec_sealDeflateTime_s	INT	INT	Corresponds to bit 12 in the AB2BR_networkOverwriteBitfield variable. Units in seconds.
AB2BR_rec_airAssistTime_s	INT	INT	Corresponds to bit 13 in the AB2BR_networkOverwriteBitfield variable. Units in seconds.
AB2BR_rec_batchAmount-Mass_lbs	REAL	REAL	Corresponds to bit 14 in the AB2BR_networkOverwriteBitfield variable. If batching is enabled, the evacuation will halt when the amount of material pumped matches this value. Units in pounds.
AB2BR_rec_batchAmountVolume_gal	REAL	REAL	Corresponds to bit 15 in the AB2BR_networkOverwriteBitfield variable. If batching is enabled, the evacuation will halt when the amount of material pumped matches this value. Units in gallons.
AB2BR_batchEnabled	BOOL	TRUE, FALSE	Corresponds to bit 16 in the AB2BR_networkOverwriteBitfield variable. This switches between an "Auto" sequence and a "Batch" sequence.
AB2BR_networkOverwriteBitfield	DINT	Bitfield	This variable is used as a bitfield, where every denoted output variable has a corresponding bit. If the remote PLC intends the SDU to read the value in from the Ethernet/IP network interface and make it active in the system, the corresponding bit for that variable must be set to TRUE in this bitfield. When a bit is set to TRUE, any value changes from the SDU's touchscreen (including loading a new recipe) will be overwritten by the network value, unless "Override Remote" is checked on the SDU Network screen. When a bit is FALSE, the SDU system ignores the network value.

Electro-pneumatic Control Panel Display Screens

Inputs to the Allen-Bradley Controller			
Variable Name	Data Type	Possible Values	Notes
BR2AB_systemState	DINT	0 (Sys Busy), 1 (Standby), 2 (Manual Run), 3 (Auto Run)	N/A
BR2AB_containerLow	BOOL	TRUE, FALSE	N/A
BR2AB_containerEmpty	BOOL	TRUE, FALSE	N/A
BR2AB_sealInflated	BOOL	TRUE, FALSE	N/A
BR2AB_systemLoaded	BOOL	TRUE, FALSE	N/A
BR2AB_batchSequenceComplete	BOOL	TRUE, FALSE	This will only be set if batch target has been achieved. If the batching sequence ends by emptying the container, the "BR2AB_autoSequenceComplete" variable will be set instead.
BR2AB_autoSequenceComplete	BOOL	TRUE, FALSE	This will be set when an Auto sequence completes, or a Batch sequence empties a container before reaching the target batch amount.
BR2AB_currentJobNumber	DINT	DINT	N/A
BR2AB_ramPosition_in	REAL	REAL	Identifies the distance from the laser position sensor to the top beam or plate of the system. Units are inches.
BR2AB_jobAmountMass_lbs	REAL	REAL	Amount of material pumped in the current job if a "Mass" type feedback is selected in system settings. Otherwise, this variable has a value of -1. Units in pounds.
BR2AB_jobAmountVolume_gal	REAL	REAL	Amount of material pumped in the current job if a "Volume" type feedback is selected in system settings. Otherwise, this variable has a value of -1. Units in gallons.
BR2AB_scaleReading_lbs	REAL	REAL	Identifies the current value of a scale if a scale is connected and configured in the system. Units in pounds.
BR2AB_evnt_eventTimestamp	DINT	DINT	Timestamp in Unix time.
BR2AB_evnt_eventGroup	SINT	0 (Alarm), 1 (Deviation), 2 (Advisory)	Has a value of 255 if no events need acknowledgment. See Event Table.
BR2AB_evnt_eventIndex	SINT	SINT	Has a value of 255 if no events need acknowledgment. See Event Table.
BR2AB_evnt_acknowledge	BOOL	TRUE, FALSE	N/A



<b>Inputs to the Allen-Bradley Controller</b>			
<b>Variable Name</b>	<b>Data Type</b>	<b>Possible Values</b>	<b>Notes</b>
BR2AB_networkInterlock	BOOL	TRUE, FALSE	N/A
BR2AB_pumpStartStop	BOOL	TRUE (Evacuate), FALSE (Stop evacuation)	N/A
BR2AB_jobComplete	BOOL	TRUE, FALSE	N/A
BR2AB_rec_loadRecipe	BOOL	TRUE, FALSE	N/A
BR2AB_rec_recipeNumber	SINT	SINT	N/A
BR2AB_rec_autoRaise	BOOL	TRUE, FALSE	N/A
BR2AB_rec_pumpSlowPressure_psi	REAL	REAL	Units in psi.
BR2AB_rec_pumpFastPressure_psi	REAL	REAL	Units in psi.
BR2AB_rec_ramUpPressure_psi	REAL	REAL	Units in psi.
BR2AB_rec_ramDownPressure_psi	REAL	REAL	Units in psi.
BR2AB_rec_ramJogPressure_psi	REAL	REAL	Units in psi.
BR2AB_rec_sealFullPressure_psi	REAL	REAL	Units in psi.
BR2AB_rec_sealPartPressure_psi	REAL	REAL	Units in psi.
BR2AB_rec_airAssistPressure_psi	REAL	REAL	Units in psi.
BR2AB_rec_primeTime_s	INT	INT	Units in seconds.
BR2AB_rec_emptyTime_s	INT	INT	Units in seconds.
BR2AB_rec_sealDeflateTime_s	INT	INT	Units in seconds.
BR2AB_rec_airAssistTime_s	INT	INT	Units in seconds.
BR2AB_rec_batchAmount-Mass_lbs	REAL	REAL	If batching is enabled, the evacuation will halt when the amount of material pumped matches this value. This has a value of -1 unless a "Mass" type feedback is selected in system settings. Units in pounds.
BR2AB_rec_batchAmountVolume_gal	REAL	REAL	If batching is enabled, the evacuation will halt when the amount of material pumped matches this value. This has a value of -1 unless a "Volume" type feedback is selected in system settings. Units in gallons.
BR2AB_batchEnabled	BOOL	TRUE, FALSE	N/A
BR2AB_networkOverwriteBitfield	DINT	Bitfield	N/A

## SDU Event Table

See [Event Log, page 41](#) for detailed event descriptions.

**NOTE:** The Event Identification Numbers in the following table consist of values from BR2AB\_evnt\_eventGroup and BR2AB\_evnt\_eventIndex (see [Variable Interface List, page 53](#)). The Event Identification Numbers are listed in the order of BR2AB\_evnt\_eventGroup, BR2AB\_evnt\_eventIndex.

Event Identification Number	Event
0,0	Software Error
0,1	E-stop or I/O Power Error
0,2	Comm. Bus Power Error
0,3	X20AO2622 Module Error
0,4	X20BC1083 Module Error
0,5	X20CM8281 Module Error
0,6	X20DO8322 Module Error
0,7	X20PS9400 Module Error
0,8	X20DS438A Module Error
0,9	Laser Position Sensor Error
0,10	Seal Pressure Sensor Error
0,11	Control Pressure Sensor Error

Event Identification Number	Event
0,12	Pump Pressure Sensor Error
0,13	Control Pressure Low
0,14	Pump Pressure Low
0,15	Interlock #1 Open
0,16	Interlock #2 Open
0,17	Seal Not Deflated
0,18	Ram Movement Timeout
0,19	Seal Inflation Timeout
0,20	Laser Sensor Obstructed
0,21	Network Communication Error
0,22	Network Interlock Open
1,0	Position Sensor Dirty
1,1	File Not Found
1,2	USB File Header Error
1,3	USB Data Format Error
1,4	USB Not Connected
1,5	USB Operation Failed
2,0	USB Import Successful
2,1	USB Export Successful

## About

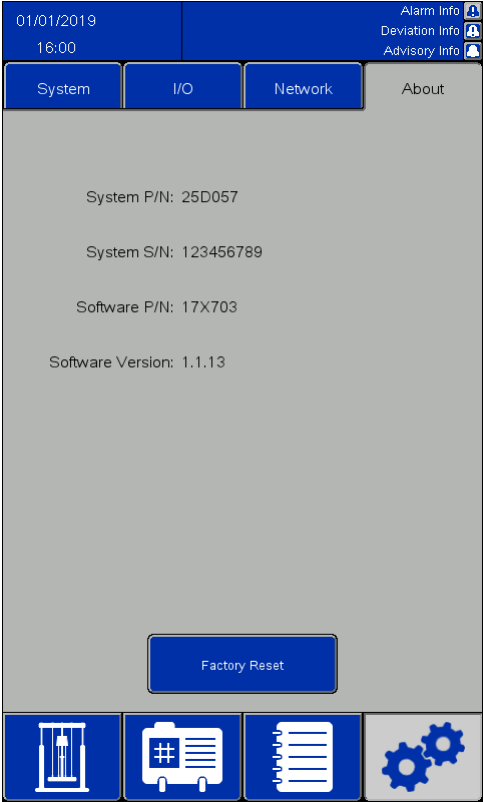

The about screen displays the SDU software information.

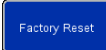

Icon/Field	Description
	Removes all user-defined data. This includes locked recipes and passwords, system configuration data, pressure settings, etc.

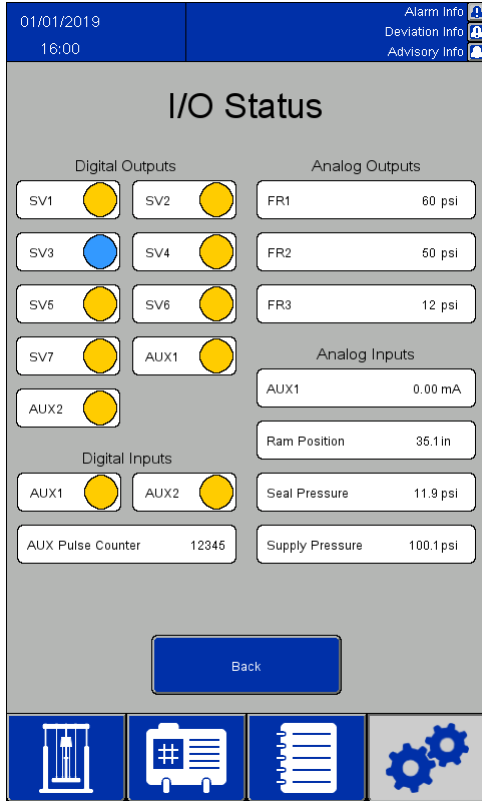
### I/O Status Screen

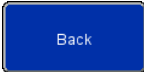

Icon / Field	Active Conditions
<b>Digital Outputs</b>	
Available settings:	
	(blue) Asserted
	(yellow) Not Asserted
<b>SV1</b>	Pump fast
<b>SV2</b>	Pump slow, pump fast
<b>SV3</b>	Ram up
<b>SV4</b>	Ram jog, ram down
<b>SV5</b>	Seal inflate
<b>SV6</b>	Air assist
<b>SV7</b>	Seal deflate
<b>Aux 1</b>	Auxiliary 1 output
<b>Aux 2</b>	Auxiliary 2 output
<b>Digital Inputs</b>	
<b>Aux 1</b>	Auxiliary 1 input
<b>Aux 2</b>	Auxiliary 2 input
<b>Aux Pulse Counter</b>	Total flow meter pulse count
<b>Analog Outputs</b>	
<b>FR1</b>	Pump pressure
<b>FR2</b>	Ram pressure
<b>FR3</b>	Seal pressure
<b>Analog Inputs</b>	
<b>Aux 1 analog input</b>	Current 4–20 mA scale reading
<b>Ram Position</b>	Current ram position reading
<b>Seal Pressure</b>	Current seal pressure reading
<b>Supply Air Pressure</b>	Current supply air pressure reading
	Return to previous screen

# Import and Export with USB

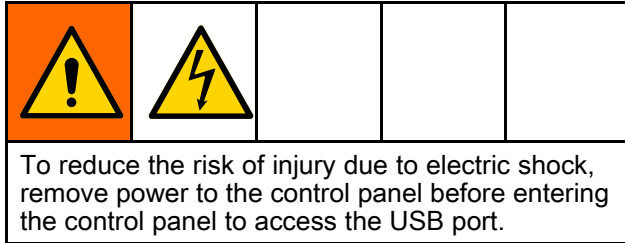

Material and Container Recipes, Event Logs, Job Logs, and System Settings can be exported to a USB device from their respective screens when the USB device is inserted into one of the two ports on the back side of the screen unit. The exported files are a .csv file type with a UTF-8 encoding.

The Material Recipes file, Container Recipes file, and the System Settings file may be edited in a program on a computer and imported back into the system once the USB device is inserted back into the back side of the screen unit. When editing files for import, use a program that supports saving the file in a UTF-8 encoding, such as Notepad. Microsoft Excel is not recommended.

If importing a file from a previous version of software than the version located on the About screen, follow these steps to avoid data loss:

1. Make a backup of the desired file on a PC.
2. Insert the USB device into the screen unit and export the desired file to obtain the up-to-date formatting of the file. **NOTE:** This will overwrite any existing file with the same name.
3. On a PC, copy the desired data from the backup file into the file created by the export. Do not copy any header information. Ensure formatting is correct, such as extra commas, the file contains the correct number of lines, and each line of data has a new line at the end of it (including the last line of the file).
4. Save the file, ensuring UTF-8 encoding. Then import it to the system.

## Settings Parameters

When modifying some elements for import, the Settings file requires use of numerical values to represent desired values. The allowable values for all fields are detailed in the following table:

Parameter Name	Value	Value Meaning
Language	0	English
	1	French
	2	Spanish
	3	German
	4	Dutch
Timezone	5	(UTC -12:00) International date line (west)
	10	(UTC -11:00) Midway Islands, Samoa
	15	(UTC -10:00) Hawaii
	20	(UTC -09:00) Alaska
	25	(UTC -08:00) Pacific Time (USA & Canada), San Francisco, Vancouver
	30	(UTC -07:00) Arizona
	35	(UTC -07:00) Mountain Time (USA & Canada), Denver, Salt Lake City
	40	(UTC -07:00) Chihuahua, Mazatlan
	45	(UTC -06:00) Guadalajara, Mexico City, Monterrey
	50	(UTC -06:00) Central Time (USA & Canada), Kansas City, Houston
	55	(UTC -06:00) Saskatchewan

Import and Export with USB

Parameter Name	Value	Value Meaning
Timezone	60	(UTC -05:00) Bogotá, Lima, Quito
	65	(UTC -05:00) New York, Miami, Atlanta, Detroit, Toronto
	70	(UTC -05:00) Cuba
	75	(UTC -05:00) Indiana (east)
	80	(UTC -04:00) Caracas, La Paz
	85	(UTC -04:00) Santiago
	90	(UTC -04:00) Atlantic Time (Canada)
	95	(UTC -03:30) Newfoundland
	100	(UTC -03:00) Greenland
	105	(UTC -03:00) Brazil
	110	(UTC -03:00) Buenos Aires, Georgetown
	115	(UTC -02:00) Mid Atlantic
	120	(UTC -01:00) Azores
	125	(UTC -01:00) Cape Verde
	130	(UTC) Dublin, Edinburgh, Lisbon, London
	135	(UTC) Casablanca, Monrovia
140	(UTC +01:00) Amsterdam, Berlin, Bern, Rome, Stockholm, Vienna	
145	(UTC +01:00) Belgrade, Bratislava, Budapest, Ljubljana, Prague	

Parameter Name	Value	Value Meaning
Timezone	150	(UTC +01:00) Brussels, Copenhagen, Madrid, Paris
	155	(UTC +01:00) West Central Africa
	160	(UTC +01:00) Sarajevo, Skopje, Warsaw, Zagreb
	165	(UTC +02:00) Athens, Beirut, Istanbul, Minsk
	167	(UTC +02:00) Kaliningrad
	170	(UTC +02:00) Bucharest
	175	(UTC +02:00) Helsinki, Kiev, Riga, Sofia, Tallinn, Vilnius
	180	(UTC +02:00) Cairo
	185	(UTC +02:00) Harare, Pretoria
	190	(UTC +02:00) Jerusalem
	195	(UTC +03:00) Nairobi
	200	(UTC +03:00) Baghdad
	205	(UTC +03:00) Kuwait, Riyadh
	210	(UTC +03:00) Moscow, St. Petersburg, Volgograd
	215	(UTC +03:30) Tehran
	220	(UTC +04:00) Abu Dhabi, Muscat
	225	(UTC +04:00) Samara
	230	(UTC +04:00) Baku, Tbilisi, Yerevan
	235	(UTC +04:30) Kabul
	240	(UTC +05:00) Yekaterinburg
245	(UTC +05:00) Islamabad, Karachi, Tashkent	

Parameter Name	Value	Value Meaning
Timezone	250	(UTC +05:30) Chennai, Calcutta, Bombay, New Delhi
	255	(UTC +05:45) Kathmandu
	260	(UTC +06:00) Almaty
	265	(UTC +06:00) Novosibirsk
	270	(UTC +06:00) Astana, Dhaka
	275	(UTC +06:00) Sri Jayawardenpura Kotte
	280	(UTC +06:30) Rangoon
	285	(UTC +07:00) Bangkok, Hanoi, Jakarta
	290	(UTC +07:00) Krasnoyarsk
	295	(UTC +08:00) Peking, Chongqing, Hong Kong, Urumqi
	300	(UTC +08:00) Irkutsk, Ulan Bator
	305	(UTC +08:00) Perth
	310	(UTC +08:00) Kuala Lumpur, Singapore
	315	(UTC +08:00) Taipei
	320	(UTC +09:00) Osaka, Sapporo, Tokyo
	325	(UTC +09:00) Seoul
	330	(UTC +09:00) Yakutsk
335	(UTC +09:30) Adelaide; Darwin	
340	(UTC +10:00) Vladivostok	
345	(UTC +10:00) Brisbane	

Parameter Name	Value	Value Meaning
Timezone	350	(UTC +10:00) Canberra, Melbourne, Sydney
	355	(UTC +10:00) Guam, Port Moresby
	360	(UTC +10:00) Hobart
	365	(UTC +11:00) Magadan, Solomon Is., New Caledonia
	367	(UTC +11:00) Srednekolymsk
	370	(UTC +12:00) Auckland, Wellington
	375	(UTC +12:00) Fiji, Kamchatka, Marshall Is.
	380	(UTC +13:00) Nuku'alofa
	Auto DST	0
1		Enabled
Date Format	0	MM/DD/YYYY
	1	DD/MM/YYYY
	2	YYYY/MM/DD
System Password	Any alphanumeric, up to 19 characters	N/A
Shutdown Time	Enter desired time (in seconds)	N/A
Job Measurement Delay	Enter desired time (in seconds)	N/A
Pressure Units	0	psi
	1	Megapascals
	2	Bar
Length Units	0	Inches
	1	Centimeters
Volume Units	0	Gallons
	1	Cubic Feet
	2	Liters
	3	Cubic Meters

*Import and Export with USB*

Parameter Name	Value	Value Meaning
Mass Units	0	Pounds
	1	Kilograms
Feedback Type	0	None
	1	Pulse Meter (Volume)
	2	Pulse Meter (Mass)
	3	Scale (Positive)
	4	Scale (Negative)
K-Factor	Enter desired pulses per unit	N/A
4 mA Mass	Enter desired mass at 4 mA	N/A
20 mA Mass	Enter desired mass at 20 mA	N/A

Parameter Name	Value	Value Meaning
AUX1/2 Input	0	None
	1	Pump Start/Stop
	2	Interlock
	3	Job Complete
AUX1/2 Output	0	None
	1	System OK
	2	Pump is Running
	3	Sequence Complete
	4	Container Low
	5	Container Empty
IP Type	0	DHCP Disabled (Static IP)
	1	DHCP Enabled
IP Address	Enter desired IP address	N/A
Subnet Mask	Enter desired subnet mask	N/A



# Dimensions

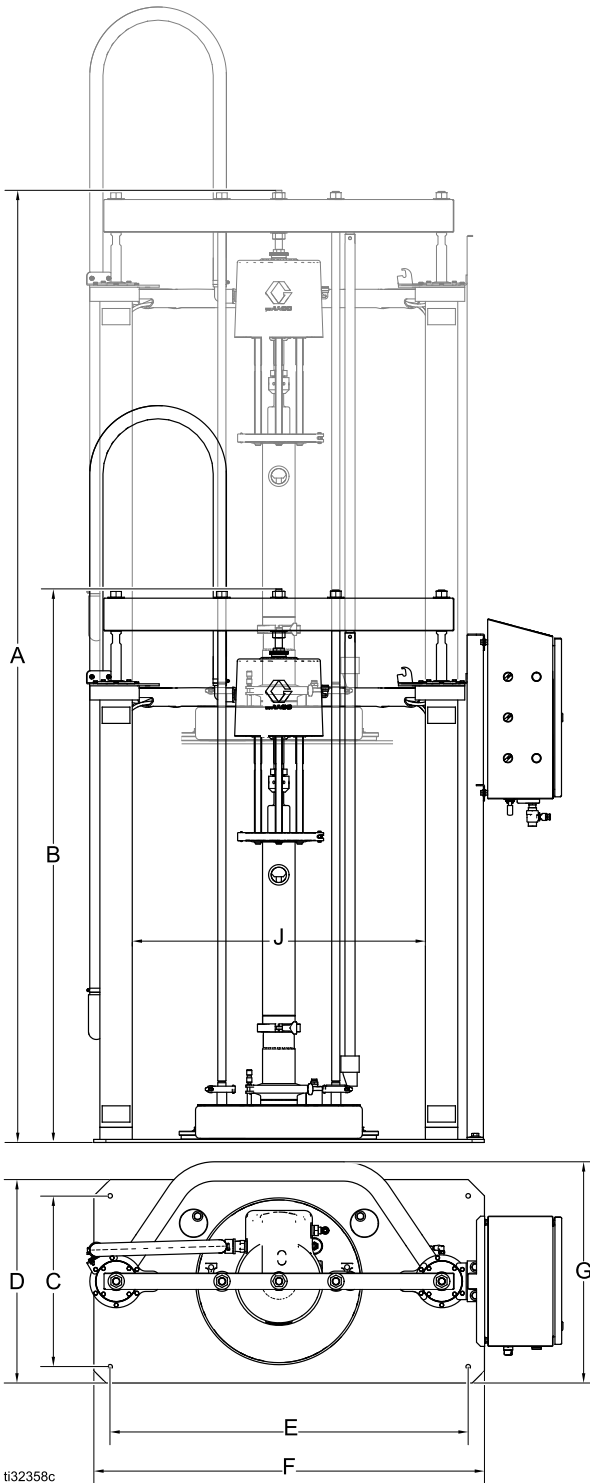

A in. (cm)	B in. (cm)	C in. (cm)	D in. (cm)	E in. (cm)	F in. (cm)	G in. (cm)	H in. (cm)	J in. (cm)
116 (295)	67.9 (172.5)	21.0 (53.3)	25.0 (63.5)	44.0 (112)	48.0 (127)	27.5 (700)	57.5 (146)	36.0 (91.4)



# Schematic (enclosed control)

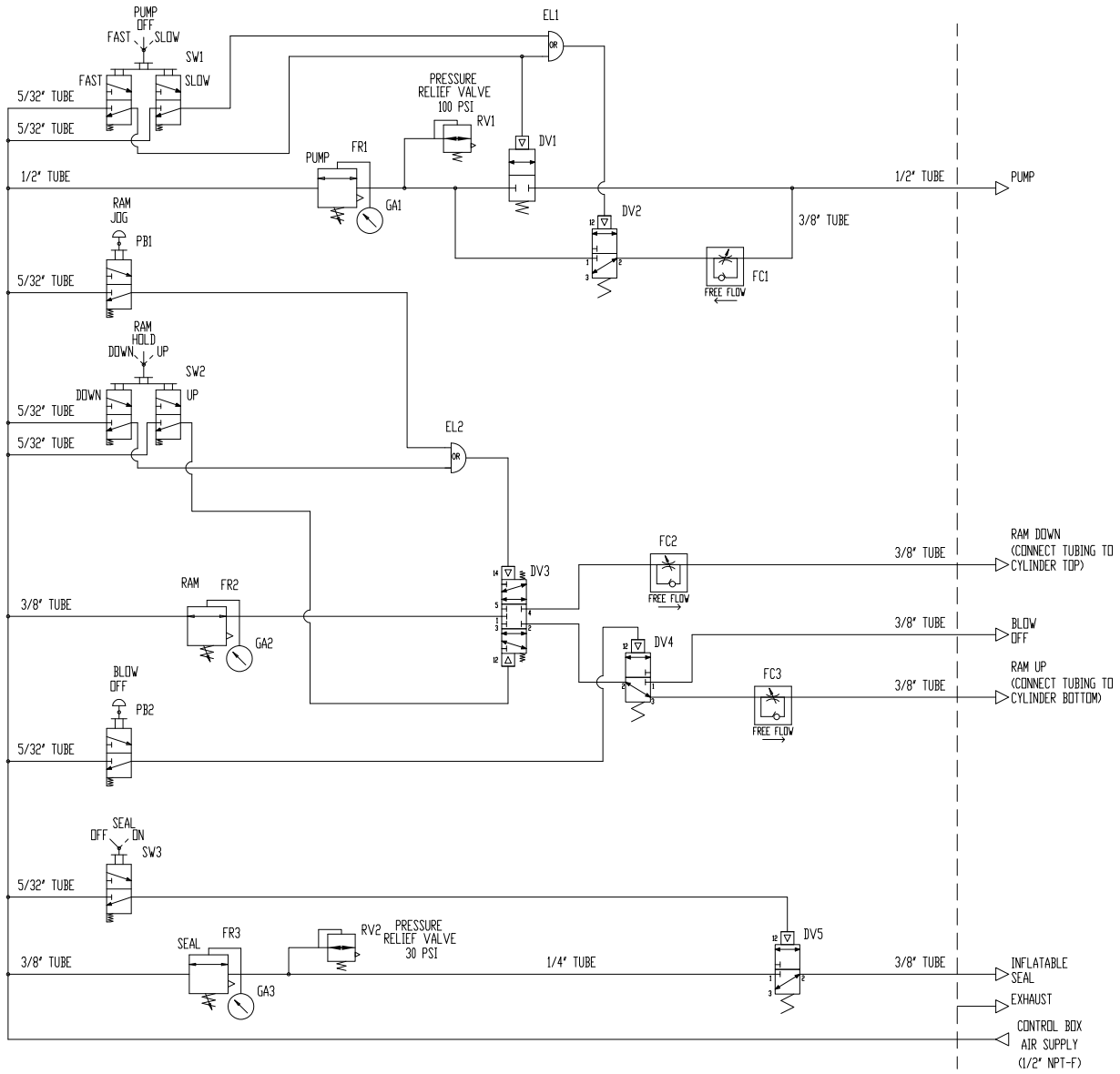

# Schematic (electo-pneumatic control)

\* Maximum 15 A branch circuit protection and disconnect switch shall be provided by the installer.

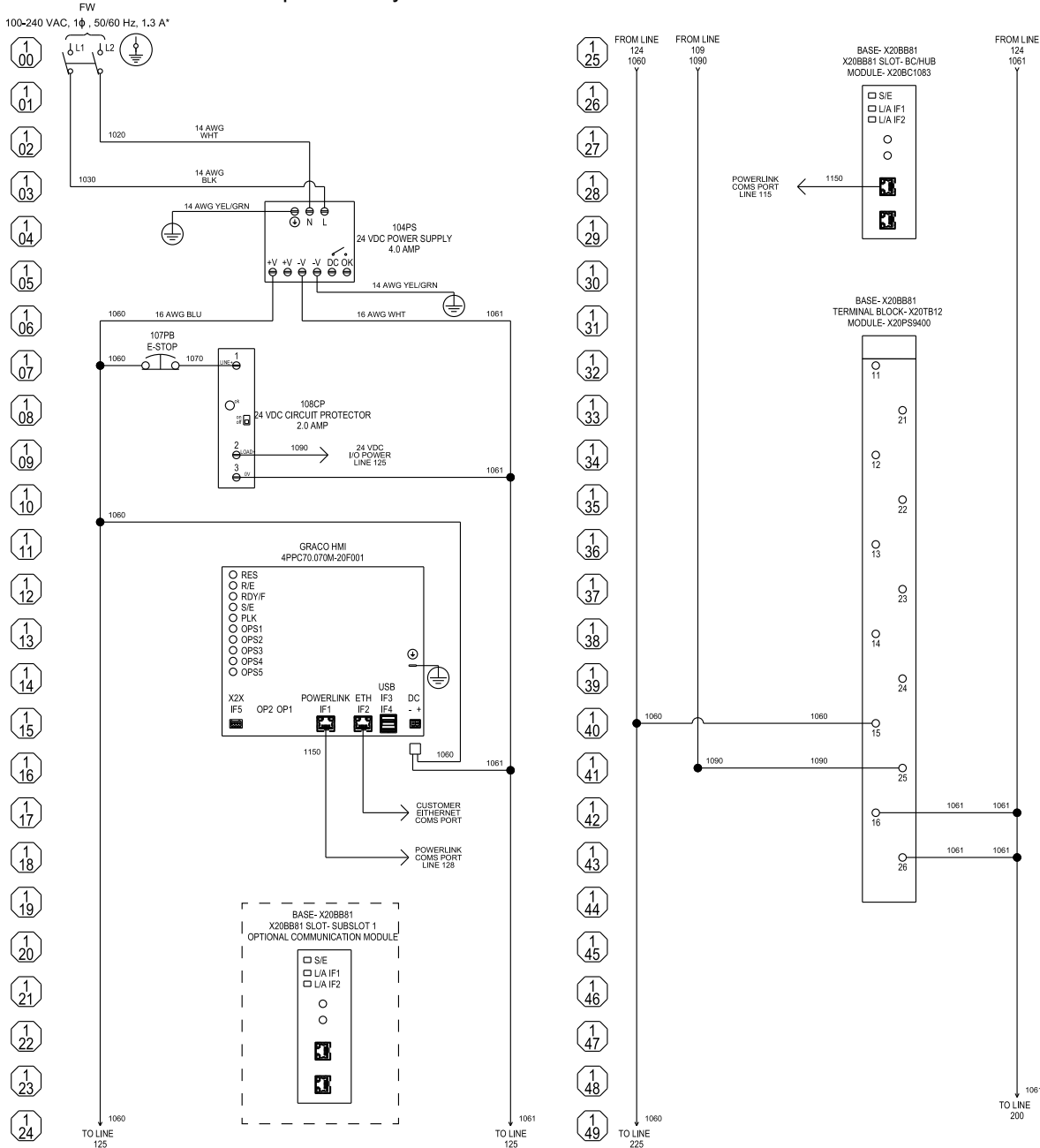

All connections marked as FW are field wired connections. Except for the equipment grounding conductor connection, all field wiring connections are to be made with 24–14 AWG stranded copper wire. The equipment grounding conductor must be 14–0/1 AWG stranded copper wire. All field wiring terminals are a class 1 control circuit.



Schematic (electo-pneumatic control)

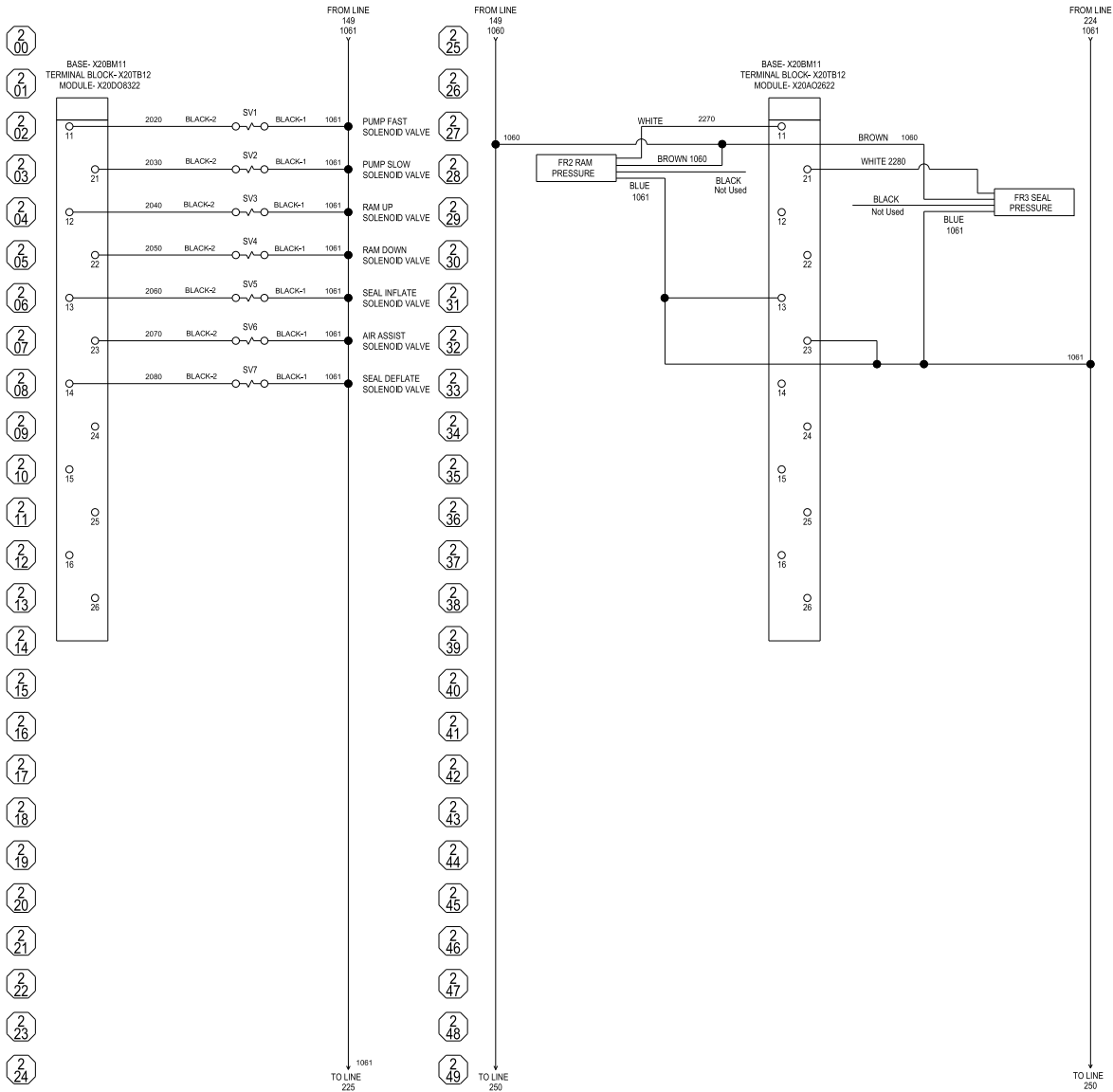

Schematic (electo-pneumatic control)

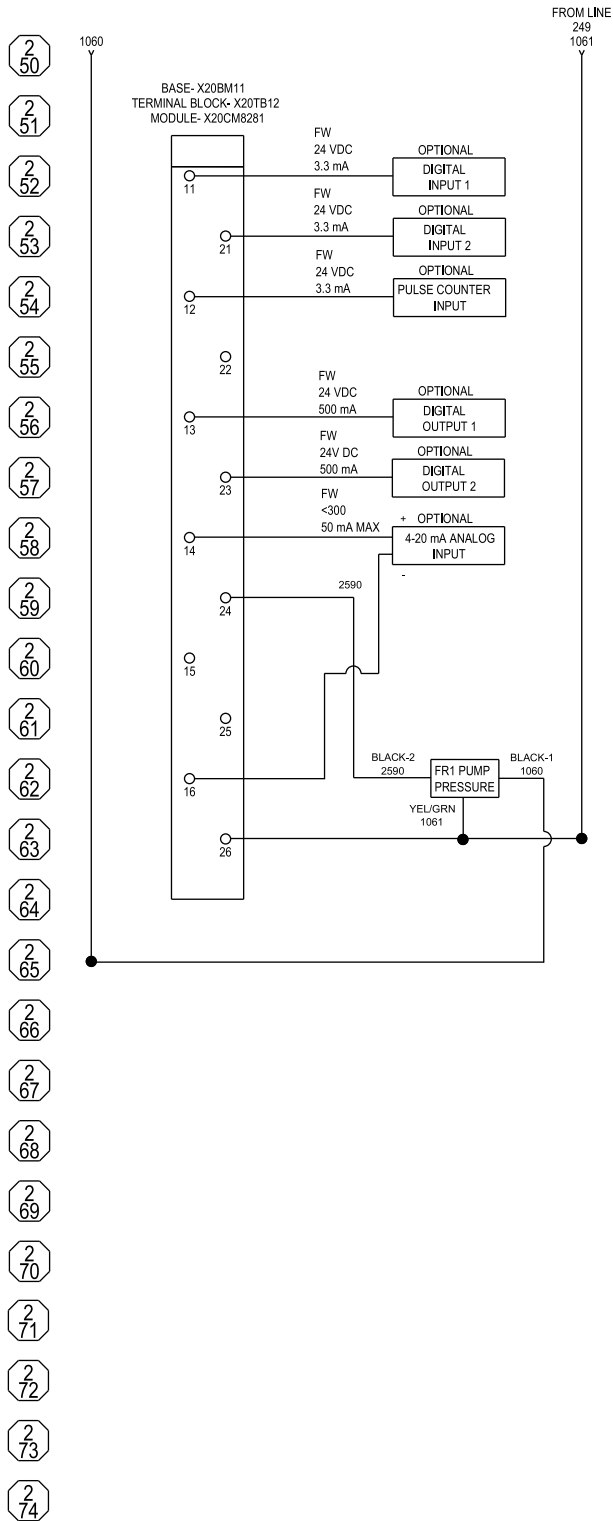

All components marked Optional are not provided with the control panel and must be provided by the installer.

*Schematic (electo-pneumatic control)*

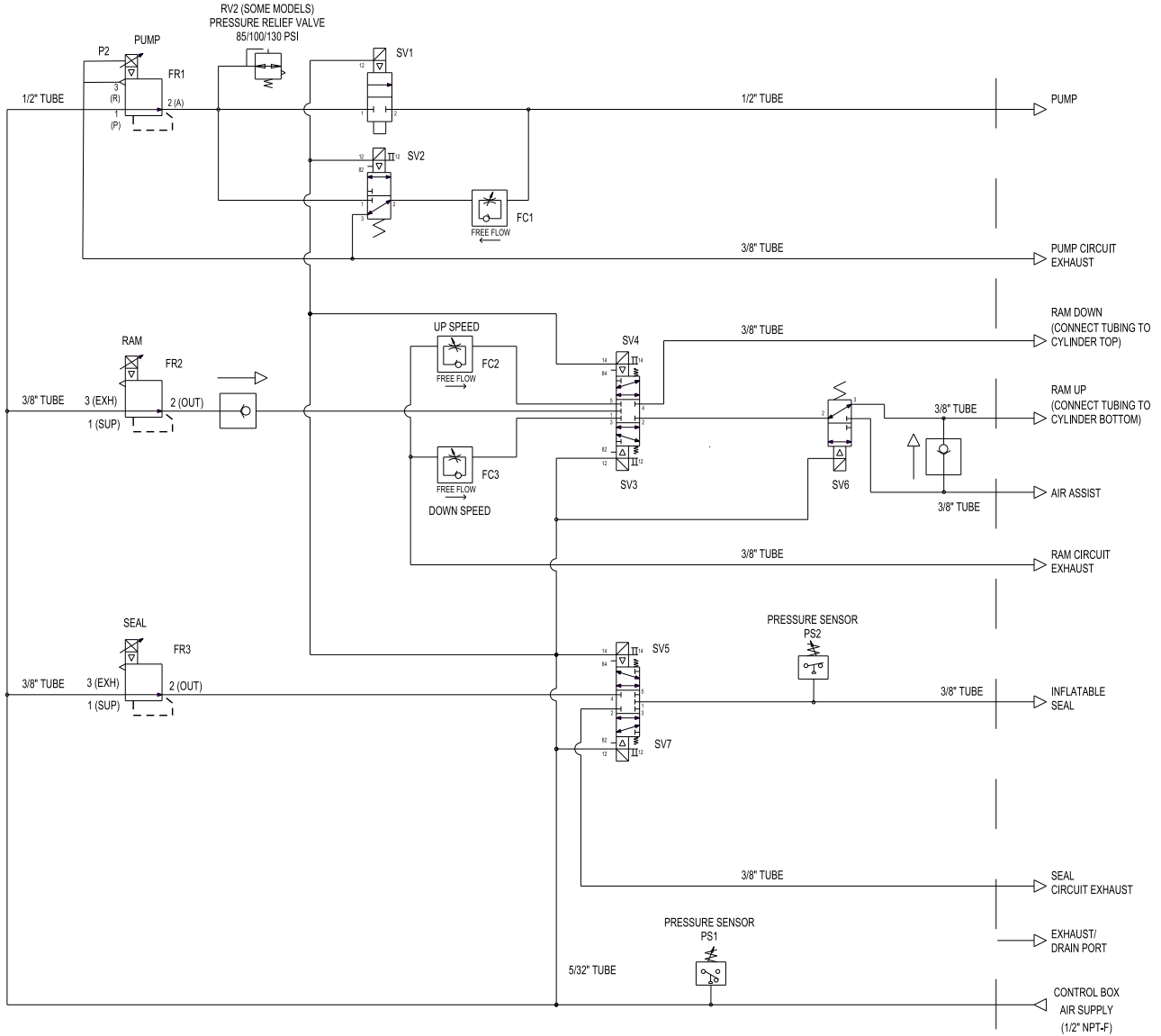

All fittings and connections emerge from the bottom of the control panel.



## Kits and Accessories

### Caster Kit (Accessory code AB)

Kit Part Number 25E152

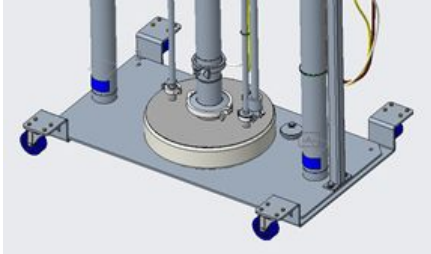

Kit includes:

- 2 dollies, each with 2 swivel casters
- Mounting hardware

### Drum Dolly (Accessory code AC)

Kit Part Number 25E153

Painted carbon steel dolly for drums up to 24 inch diameter. Load rating of 2000 pounds.



Kit contains:

- Dolly with 5 swivel casters
- Mounting hardware
- Vinyl rubber ramp

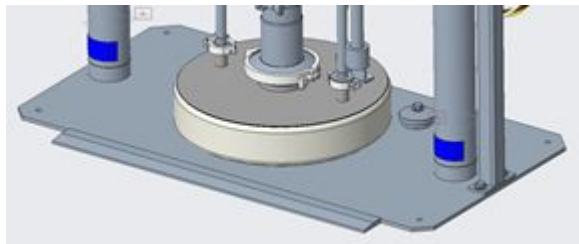

### Stainless Steel Piston Rods (Accessory code AE)

Kit Part Number 25E136

Provides added corrosion protection.

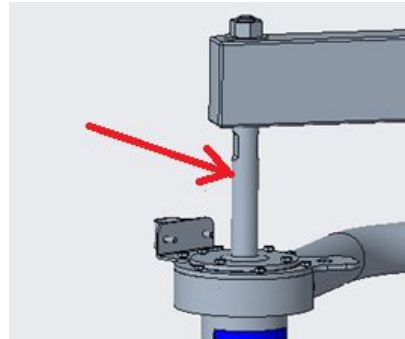

Kit contains:

- 316 stainless steel piston rods

# Notes

---

---

---

---

---

---

---

---

---

---

---

---

---

---

---

---

---

---

---

# Technical Data

	US	Metric
Maximum fluid working pressure		
5:1 pump	410 psi	2.9 MPa, 28.7 bar
6:1 pump	650 psi	4.5 MPa, 44.8 bar
12:1 pump	1200 psi	8.3 MPa, 83 bar
1:1 diaphragm pumps	120 psi	0.8 MPa, 8 bar
Maximum system air inlet pressure	100 psi	0.69 MPa, 6.9 bar
Ambient temperature range	41–104°F	5–40°C
Air consumption	See pump manual	
Maximum recommended pump speed		
Maximum fluid temperature		
Fluid Outlet Size		
Wetted Parts		
Maximum weight (system with 12:1 pump)	615 lbs	279 kg
<b>Electro-pneumatic Control Panel</b>		
Enclosure Type: 4X (IP65) Voltage: 100–240 VAC Phase: 1 Frequency: 50/60 Hz Maximum Current: 1.3 A <b>NOTE:</b> Branch Circuit Protection (maximum 15 A) and disconnect switch not provided.		
<b>Sound data</b>		
Sound power*	78.5 dBa	
Sound pressure**	71.6 dBa	

\* Sound power at 70 psi (0.48 MPa, 4.8 bar), 20 cpm. Sound power measured per ISO-9614–2.

\*\* Sound pressure was tested 3.28 feet (1 m) from equipment.

## California Proposition 65

### CALIFORNIA RESIDENTS

 **WARNING:** Cancer and reproductive harm — [www.P65warnings.ca.gov](http://www.P65warnings.ca.gov).

# Graco Standard Warranty

Graco warrants all equipment referenced in this document which is manufactured by Graco and bearing its name to be free from defects in material and workmanship on the date of sale to the original purchaser for use. With the exception of any special, extended, or limited warranty published by Graco, Graco will, for a period of twelve months from the date of sale, repair or replace any part of the equipment determined by Graco to be defective. This warranty applies only when the equipment is installed, operated and maintained in accordance with Graco's written recommendations.

This warranty does not cover, and Graco shall not be liable for general wear and tear, or any malfunction, damage or wear caused by faulty installation, misapplication, abrasion, corrosion, inadequate or improper maintenance, negligence, accident, tampering, or substitution of non-Graco component parts. Nor shall Graco be liable for malfunction, damage or wear caused by the incompatibility of Graco equipment with structures, accessories, equipment or materials not supplied by Graco, or the improper design, manufacture, installation, operation or maintenance of structures, accessories, equipment or materials not supplied by Graco.

This warranty is conditioned upon the prepaid return of the equipment claimed to be defective to an authorized Graco distributor for verification of the claimed defect. If the claimed defect is verified, Graco will repair or replace free of charge any defective parts. The equipment will be returned to the original purchaser transportation prepaid. If inspection of the equipment does not disclose any defect in material or workmanship, repairs will be made at a reasonable charge, which charges may include the costs of parts, labor, and transportation.

**THIS WARRANTY IS EXCLUSIVE, AND IS IN LIEU OF ANY OTHER WARRANTIES, EXPRESS OR IMPLIED, INCLUDING BUT NOT LIMITED TO WARRANTY OF MERCHANTABILITY OR WARRANTY OF FITNESS FOR A PARTICULAR PURPOSE.**

Graco's sole obligation and buyer's sole remedy for any breach of warranty shall be as set forth above. The buyer agrees that no other remedy (including, but not limited to, incidental or consequential damages for lost profits, lost sales, injury to person or property, or any other incidental or consequential loss) shall be available. Any action for breach of warranty must be brought within two (2) years of the date of sale..

**GRACO MAKES NO WARRANTY, AND DISCLAIMS ALL IMPLIED WARRANTIES OF MERCHANTABILITY AND FITNESS FOR A PARTICULAR PURPOSE, IN CONNECTION WITH ACCESSORIES, EQUIPMENT, MATERIALS OR COMPONENTS SOLD BUT NOT MANUFACTURED BY GRACO.** These items sold, but not manufactured by Graco (such as electric motors, switches, hose, etc.), are subject to the warranty, if any, of their manufacturer. Graco will provide purchaser with reasonable assistance in making any claim for breach of these warranties..

In no event will Graco be liable for indirect, incidental, special or consequential damages resulting from Graco supplying equipment hereunder, or the furnishing, performance, or use of any products or other goods sold hereto, whether due to a breach of contract, breach of warranty, the negligence of Graco, or otherwise.

## FOR GRACO CANADA CUSTOMERS

The Parties acknowledge that they have required that the present document, as well as all documents, notices and legal proceedings entered into, given or instituted pursuant hereto or relating directly or indirectly hereto, be drawn up in English. Les parties reconnaissent avoir convenu que la rédaction du présente document sera en Anglais, ainsi que tous documents, avis et procédures judiciaires exécutés, donnés ou intentés, à la suite de ou en rapport, directement ou indirectement, avec les procédures concernées.

## Graco Information

For the latest information about Graco products, visit [www.graco.com](http://www.graco.com).

For patent information, see [www.graco.com/patents](http://www.graco.com/patents).

**To place an order**, contact your Graco Distributor or call to identify the nearest distributor.

**Phone:** 612-623-6921 **or Toll Free:** 1-800-328-0211 **Fax:** 612-378-3505

All written and visual data contained in this document reflects the latest product information available at the time of publication.

Graco reserves the right to make changes at any time without notice.  
Original Instructions. This manual contains English. MM 3A5402

**Graco Headquarters:** Minneapolis  
**International Offices:** Belgium, China, Japan, Korea

**GRACO INC. AND SUBSIDIARIES • P.O. BOX 1441 • MINNEAPOLIS MN 55440-1441 • USA**  
**Copyright 2018, Graco Inc. All Graco manufacturing locations are registered to ISO 9001.**

[www.graco.com](http://www.graco.com)

Revision N, May 2023