

HV-2100C Jet Controller

3A6226D

Diaphragm-Jet™ Technology

EN

HV-2100C Jet Controller, P/N 25B092 and 25B091

For non-contact dispensing of viscous material in industrial environments.

For professional use only.

Not approved for use in explosive atmospheres or hazardous locations.



Important Safety Instructions

Read all warnings and instructions in this manual and all related manuals before using this equipment. Save these instructions.



Table of Contents

Models	4
Related Manuals	4
Warnings	5
1. Introduction and Specifications	6
1.1 Advanjet HV-2100C Overview	6
1.2 Technical Specifications	7
1.3 Technical Assistance	7
1.4 HV-2100C Controller Dimensions	8
1.5 HV-2100C Front Panel Features	9
1.6 HV-2100C Rear Panel Features	10
2. Installation and Setup	11
2.1 Physical Placement	11
2.2 Pneumatic Connections	11
2.3 Cable Connections	12
2.4 Input / Output Connector.....	13
3. HV-2100C Front Panel Controls	14
3.1 Jet and Fluid Pressure Regulators.....	14
3.2 Temperature Controller.....	15
3.3 Trigger Button and LED	16
3.4 Main Power Switch	16
4. HV-2100C Touch Display Operation	17
4.1 Using the Touch Display	17
4.2 Home Screen.....	19
4.3 Setting Menu.....	22
4.4 Fluid Pressure Compensation Menu.....	24
4.5 Compensation Menu Example.....	27
Appendix 1: RS-232C Communication	30
Appendix 2: Timing Recipes	31
Appendix 2-1: Recipe Time Parameters	31
Appendix 2-2: Programming Timing Recipes.....	32
Appendix 2-3: Trigger Map	33
Appendix 2-4: DROP Mode Programming.....	34
Appendix 2-5: LINE Mode Programming	35
Appendix 3: First Drop Compensation	37
Appendix 3-1: Background.....	37
Appendix 3-2: Calculating First Drop Compensation	37
Appendix 3-3: First Drop Compensation in PULSE Mode	38
Appendix 3-4: First Drop Compensation in LEVEL Mode	40

Table of Contents

Appendix 4: Advanjet Controller Commands (ACC)	41
Appendix 4-1: The RS-232C Interface	42
Appendix 4-2: Command Format	42
Appendix 4-3: Recipe Timing Commands	42
Appendix 4-4: Jetting Commands	44
Appendix 4-5: Pressure Commands	46
Appendix 4-6: HV-2100C Heater Commands	47
Appendix 4-7: Output Commands	48
Appendix 5: Temperature Controller Factory Settings	49
Appendix 6: Digital Pressure Gauge	50
Appendix 6-1: Specifications	50
Appendix 6-2: Part Names and Functions	51
Appendix 6-3: Connections and Input/Output Circuit	52
Appendix 6-4: Operation Mode Selection	53
Appendix 6-5: Operation Mode Selection	54
Appendix 6-6: Adjustment	55
Appendix 6-7: Other Functions and Error Indications	56
Appendix 7: Input/Output Connector	57
Appendix 7-1: HM-2100C I/O Connector	57
Appendix 7-2: HD26 I/O Cable Overview	57
Appendix 7-3: I/O Cable Pins 1 – 9	58
Appendix 7-4: I/O Cable Pins 10 – 17	60
Appendix 7-5: I/O Cable Pins 18 - 26	62
Graco Standard Warranty	64

Models

Part Number	Model
25B092	HV-2100C Jet Controller, standalone
25B091	HV-2100C Jet Controller included with B-300 System







Related Manuals

Manuals are available at www.graco.com. Component manuals below are in English:

3A6244	HV-2100 Jet Setup and Operation
3A6326	HV-2100 Jet Maintenance and Repair
3A5937	Jet Dispensing Parameters Supplement
3A5908	Jet Maintenance Tool Kits

Warnings

The following warnings are for the setup, use, grounding, maintenance, and repair of this equipment. The exclamation point symbol alerts you to a general warning and the hazard symbols refer to procedure-specific risks. When these symbols appear in the body of this manual or on warning labels, refer back to these Warnings. Product-specific hazard symbols and warnings not covered in this section may appear throughout the body of this manual where applicable.

 WARNING	
	<p>ELECTRIC SHOCK HAZARD This equipment must be grounded. Improper grounding, setup, or usage of the system can cause electric shock.</p> <ul style="list-style-type: none"> ▪ Turn off and disconnect power cord before servicing equipment. ▪ Connect only to grounded electrical outlets. ▪ Use only 3-wire extension cords. ▪ Ensure ground prongs are intact on power and extension cords.
	<p>TOXIC FLUID OR FUMES HAZARD Toxic fluids or fumes can cause serious injury or death if splashed in the eyes or on skin, inhaled, or swallowed.</p> <ul style="list-style-type: none"> ▪ Read Safety Data Sheets (SDSs) to know the specific hazards of the fluids you are using. ▪ Store hazardous fluid in approved containers and dispose of it according to applicable guidelines.
	<p>BURN HAZARD Equipment surfaces and fluid that is heated can become very hot during operation. To avoid severe burns: Do not touch hot fluid or equipment.</p>
	<p>PERSONAL PROTECTIVE EQUIPMENT Wear appropriate protective equipment when in the work area to help prevent serious injury, including eye injury, hearing loss, inhalation of toxic fumes, and burns. Protective equipment includes but is not limited to:</p> <ul style="list-style-type: none"> ▪ Protective eyewear, and hearing protection. ▪ Respirators, protective clothing, and gloves as recommended by the fluid and solvent manufacturer.
	<p>EQUIPMENT MISUSE HAZARD Misuse can cause death or serious injury.</p> <ul style="list-style-type: none"> ▪ Do not operate the unit when fatigued or under the influence of drugs or alcohol. ▪ Do not exceed the maximum working pressure or temperature rating of the lowest rated system component. See Technical Specifications in all equipment manuals. ▪ Use fluids and solvents that are compatible with equipment wetted parts. See Technical Specifications in all equipment manuals. Read fluid and solvent manufacturer's warnings. For complete information about your material, request SDSs from distributor or retailer. ▪ Turn off all equipment and relieve air pressure when equipment is not in use. ▪ Check equipment daily. Repair or replace worn or damaged parts immediately with genuine manufacturer's replacement parts only. ▪ Do not alter or modify equipment. Alterations or modifications may void agency approvals and create safety hazards. ▪ Make sure all equipment is rated and approved for the environment in which it is used. ▪ Use equipment only for its intended purpose. Contact your distributor for information. ▪ Route hoses and cables away from traffic areas, sharp edges, moving parts, and hot surfaces. ▪ Do not kink or over bend hoses or use hoses to pull equipment. ▪ Keep children and animals away from work area. ▪ Comply with all applicable safety regulations.

1. Introduction and Specifications

1.1 Advanjet HV-2100C Overview

The Advanjet HV-2100C controller provides timing signals as well as pneumatic and electrical resources for the Advanjet HV-2100 Diaphragm Jet.

- The HV-2100C provides timing signals to drive a rapid-response solenoid valve in the jet. Its internal computer remembers and executes a variety of operational sequences. The controller can respond to actuation signals from either a front panel switch or from an external switch.
- The HV-2100C provides regulated, pressurized air output for the HV-2100 jet fluid pressure input and jet pressure input.
- The HV-2100C provides electrical power to a heater element in the HV-2100 jet and controls the temperature of the jet heater by monitoring an RTD temperature sensor.

1.2 Technical Specifications

PARAMETER	SPECIFICATION
Size	Width: 254.0 mm (10.0 in) Height: 146.0 mm (5.8 in) Depth: 309.0 mm (12.2 in) Weight: 3.12 Kg (6.89 lbs)
Drop Parameters	Refill time and Dwell (0.1 msec resolution) Number of drops (programmable from 1 to 1M)
Recipes	6 independent recipes, manual or remote triggers
Nozzle Heater Controller	Heating to 70 °C Max (158 °F) Programmable shutoff timer; 2 alarms; PID control using platinum RTD; 24 VDC, 10 W
First Drop Compensation	2 levels with programmable time interval
Fluid Pressure Compensation	12 programmable time intervals at 0.1 psi resolution
Interface	RS-232C Serial Port LCD Touch Display
Input/Output	6 TTL level triggers
Operating Temperature	15 °C to 50 °C (59 °F to 122 °F)
Input Pressure	0.6 MPa (90 psi) - maximum
Input Power	100 – 240 VAC, 50-60 Hz Fuse: 5x20 mm, Quick-Acting, 1.6 amp, 250 VAC
Advanjet Software	Windows XP, Vista, Windows 7, Windows 8, and Windows 10

1.3 Technical Assistance

Advanjet
926 Andreasen Dr. # 108
Escondido, CA 92029
USA

Phone: +1 800 333 4877
Web: www.advanjet.com
E-mail: info@advanjet.com

1.4 HV-2100C Controller Dimensions

Shown below are the mechanical dimensions of the HV-2100C. Units are in millimeters [inches].

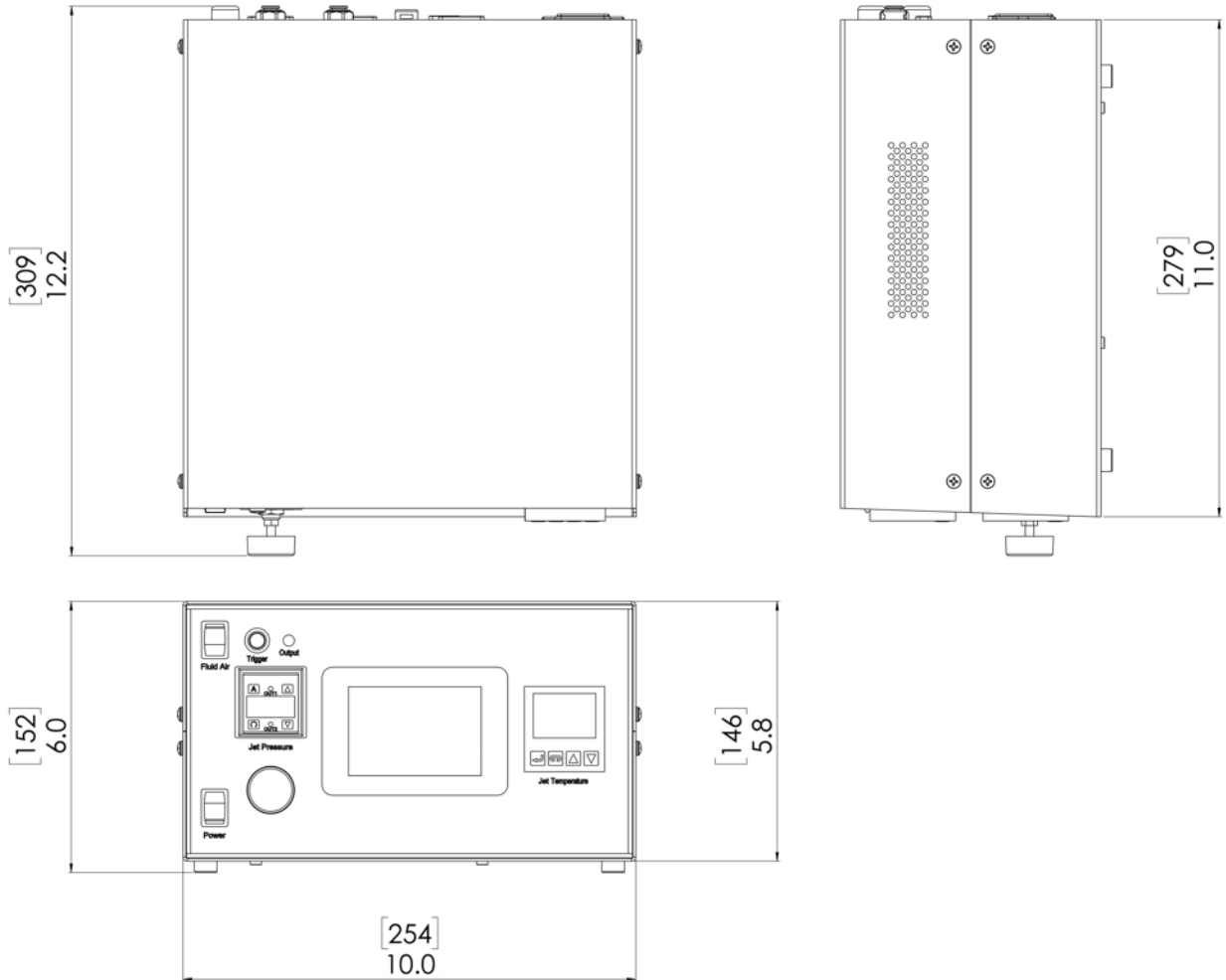

1.5 HV-2100C Front Panel Features

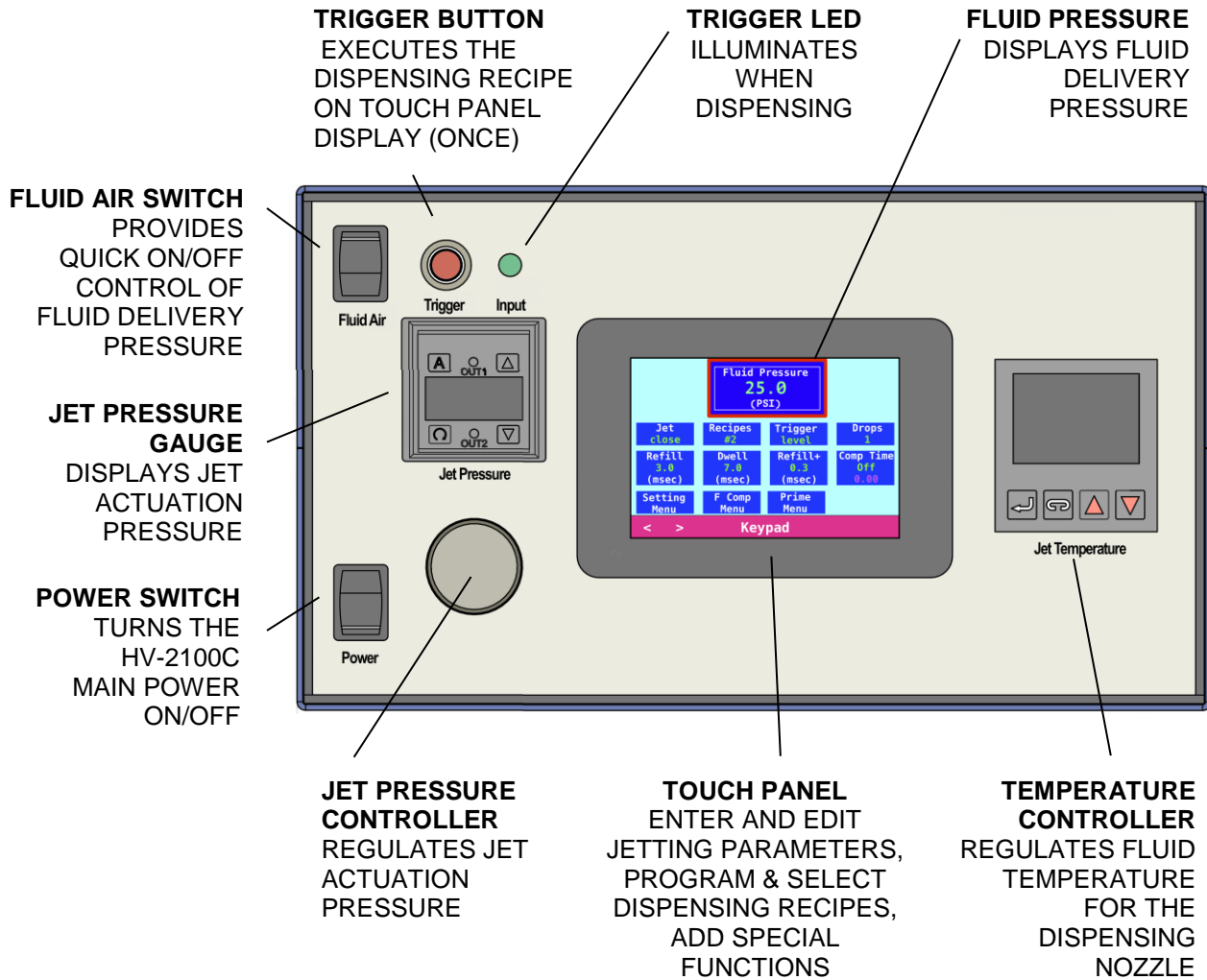

1.6 HV-2100C Rear Panel Features

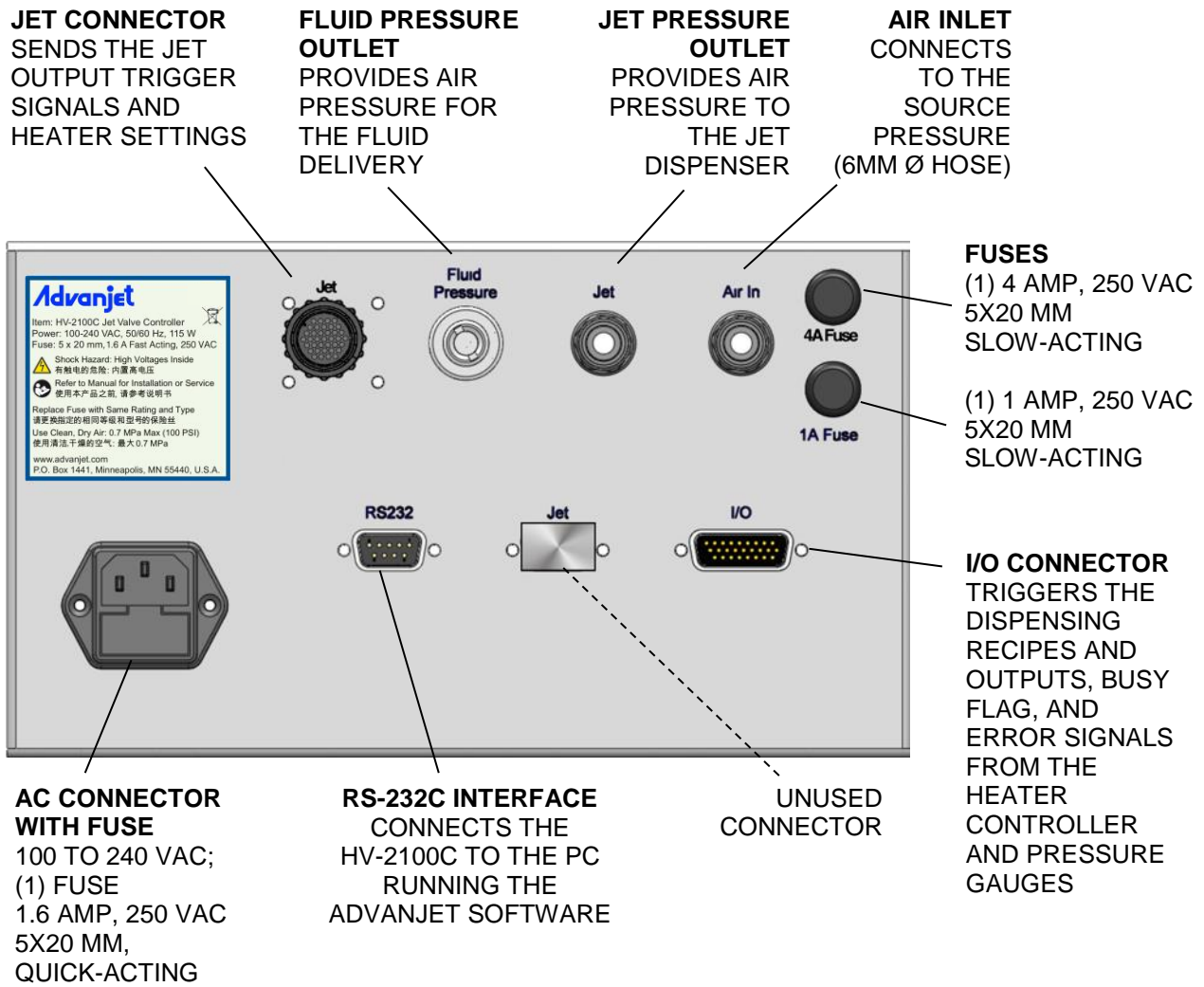

2. Installation and Setup

2.1 Physical Placement

The HV-2100C controller should be placed in a location where the front panel controls can be viewed and accessed. The ventilation holes on the sides should not be blocked.

2.2 Pneumatic Connections

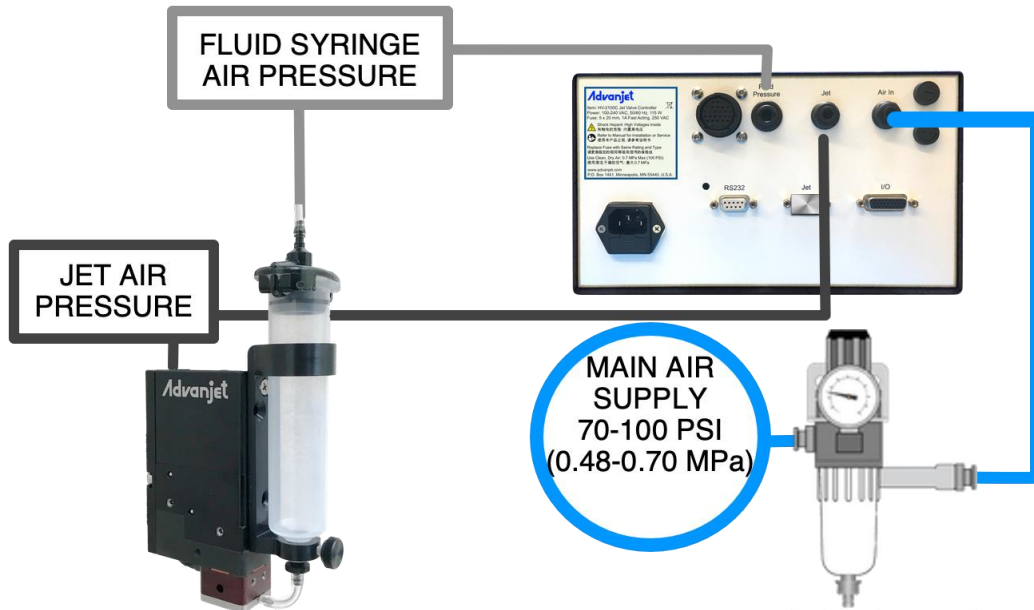

Figure 2-1: HV-2100C Pneumatic Connections

Main Air Supply: Connect a filtered (40-micron filter or better) and independently regulated main air source. It is highly recommended to place a drying system or desiccant dryer in line with the main air line. A 6mm OD air tube with a slip connect coupler is supplied to connect the HV-2100C to the main air supply. The main air supply pressure should be between 70 and 100 psi (0.48 and 0.70 MPa).

Fluid Syringe Air Pressure: The HV-2100C delivers fluid syringe air pressure through clear 4 mm OD tubing that is attached to the receiver head and has a twist-lock connector to the controller. The fluid syringe air supply should be at maximum 60 psi (0.41 MPa); normal fluid pressure is usually between 10 and 50 psi (0.06 and 0.34 MPa). Variations in the air pressure source can adversely affect the consistency of the drop size.

Jet Air Pressure: The HV-2100C delivers jet air pressure through black 6 mm OD tubing with a quick-connect coupler to the controller and an air fitting for the jet. The jet air supply must be clean and dry and at a maximum pressure of 75 psi (0.51 MPa); normal jet air operation is usually between 35 and 75 psi (0.24 and 0.51 MPa).

NOTICE

It is imperative that the air supplied to the HV-2100 is clean, dry, and free from debris and water. A 40-micron filter, a water separator, and an overpressure relief valve set at around 120 psi (0.83 MPa) are highly recommended. If the air is not clean and dry, serious damage can occur to the air solenoid valves.

2.3 Cable Connections

Figure 2-2 shows the cable connections for a typical dispensing system. To assure proper connections, component cables supplied by Advanjet have a distinct connector. Be sure that all power is off when connecting and disconnecting any cable to the Advanjet controller.

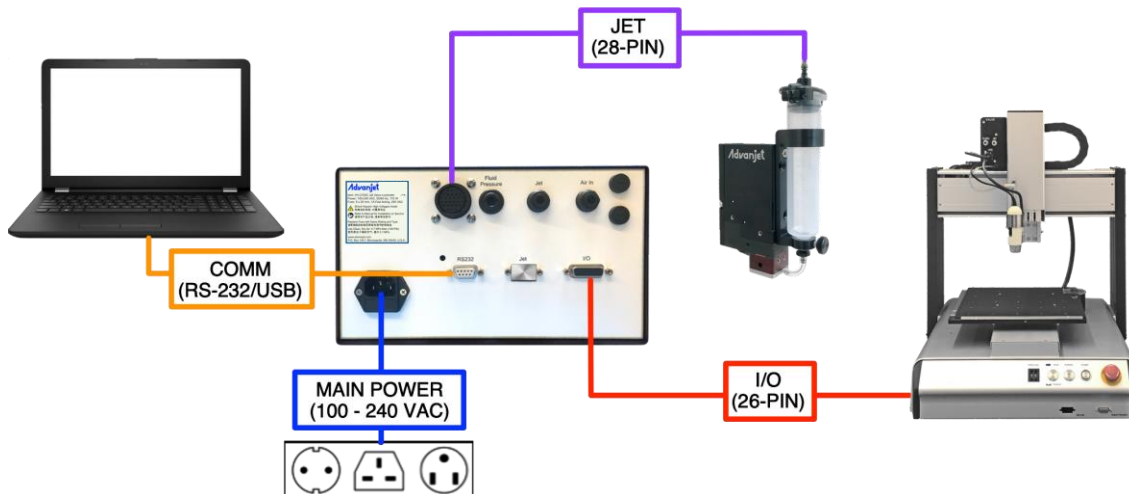

Figure 2-2: Cable Connections

Jet: A 28-pin cable (P/N 06-1095-00) mates with the HV-2100 jet cable to connect it to the HV-2100C controller.

I/O: The HV-2100C provides six TTL trigger lines to control jet operations through a 26-pin cable (P/N CB26-005) that connects the jet to a robot. Appendix 7: Input/Output Connector provides HV-2100 I/O Cable pin assignments.

COMM: A PC can be connected to the controller via RS-232C/USB to operate the HV-2100 jet using software instead of the HV-2100C front panel touch screen.

Power: Three power cords are supplied for the HV-2100C:

- Standard connector, 115V, 10A, for USA, Mexico, Canada, Taiwan, and similar (P/N 121055)
- Connector for UK, Australia and similar (P/N 124864)
- Euro connector, 250V (P/N121056)

The Advanjet controller is grounded through the power cord. Connect the power cord to a properly grounded power source before operating.

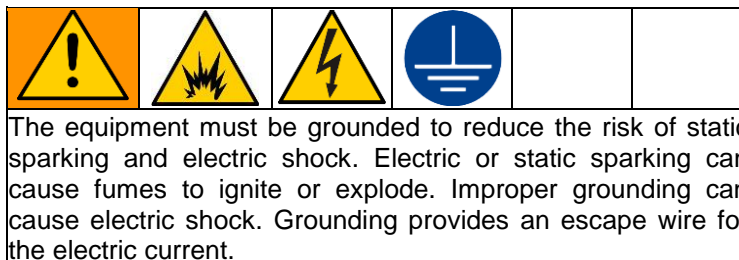

2.4 Input / Output Connector

A standard 5-foot 26-pin I/O cable is supplied with the controller; a mating 5-foot I/O cable is supplied with the jet.

- Pins 1 through 6 of the I/O cable are outputs from the robot to the controller. They can be relay contacts or TTL outputs capable of sinking 2 mA of current.
- Pin 7 outputs a busy status flag from the controller to the robot.
- Pin 8 is an external interrupt used to remotely stop a dispensing program
- Pins 9, 14, and 22 are connected to System Ground
- Pins 10, 15, 16, and 17 are uncommitted pins reserved for future features
- Pins 18 and 23 through 26 are alarms from the heater and pressure sensors
- Pins 19, 20, and 21 are unavailable; HV-2100C fluid pressure is regulated electronically.

Refer to Appendix 7: Input/Output Connector for I/O pin specifications and schematics.

I/O PIN ASSIGNMENTS	
HD26 PIN #	HV-2100C
1	Recipe 1 (Input)
2	Recipe 2 (Input)
3	Recipe 3 (Input)
4	Recipe 4 (Input)
5	Recipe 5 (Input)
6	Recipe 6 (Input)
7	Busy Flag (Output)
8	Stop (Input)
9	GND
10	no connection
11	Analog input
12	+24V fused
13	Analog output
14	GND
15	no connection
16	no connection
17	no connection
18	Heater Alarm Common (Output)
19	no connection
20	no connection
21	no connection
22	Jet Pressure Alarm Common (Output) DGND
23	Jet Pressure Alarm 2 (Output)
24	Jet Pressure Alarm 1 (Output)
25	Heater Alarm 1 (Output)
26	Heater Alarm 2 (Output)

3. HV-2100C Front Panel Controls



Figure 3-1: HV-2100C Front Panel Controls

3.1 Jet and Fluid Pressure Regulators

The HV-2100C controller has two integrated air regulators that control air pressure to the Fluid supply and to the Jet.

The actual Fluid Pressure is displayed at the top of the home screen. Units can be displayed in either psi or MPa. Fluid Pressure is controlled by an electronic pressure regulator. To set Fluid Pressure, tap **FLUID PRESSURE** on the Touch Display and enter the value.

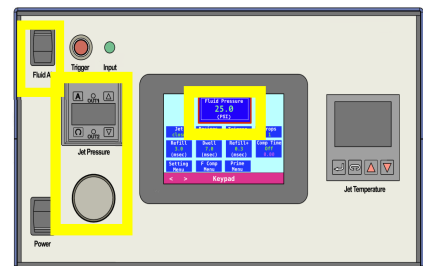

Figure 3-2: Jet and Fluid Pressure Regulators



Figure 3-3: Fluid Air Switch

The Fluid Air Switch allows the operator to instantly turn Fluid Pressure ON or OFF. This is very convenient when changing fluid or cleaning the jet.

Figure 3-4 shows the Jet Pressure Gauge and Regulator. The default Jet Pressure unit on the HV-2100C is psi (1 psi = 0.00689 MPa). Details from the pressure regulator manufacturer are in Appendix 6: Digital Pressure Gauge. Jet Pressure is easily increased or decreased by turning the knob clockwise or counterclockwise.



Figure 3-4: Jet Pressure Gauge and Regulator

3.2 Temperature Controller

The HV-2100C temperature controller regulates the temperature of the nozzle. The dispensing fluid is not heated.

The temperature controller main menu displays the present temperature value (PV) in red on the top line of the display and the set point temperature value (SV) in green on the bottom line of the display.

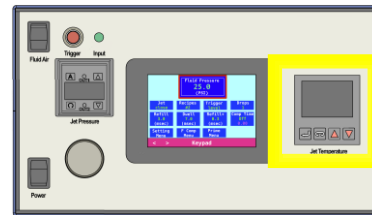





Figure 3-5: HV-2100C Temperature Controller



Figure 3-6: Present Value (PV), Set Value (SV), ENTER Key and INDEX Key

Use the  (INDEX) key to cycle through the menu options on the PV line, the   keys to scroll through settings or increase or decrease temperature values, and the  (ENTER) key to save an input and exit the menu.

To turn the heater ON:









- Press  until the Run-Stop Output Control screen (r-S) is on the PV line.
- Use the  key to select the **rUn** setting.
- Press the  key to save the change. Now the heater is turned ON.
- Press the  key again to return to the main screen display.



Figure 3-7: Turn ON the Heater

To turn the heater OFF:

- Press  until the Run-Stop screen is displayed (r-S).
- Use the  key to select the **Stop** setting.
- Press the  key to save the change. Now the heater is turned OFF.
- Press the  key again to return to the main screen display.

To change the Set Value (SV) temperature:





Use the   keys to increase or decrease the value. For example, to change SV from 20 to 45 degrees, use the  key to increase the SV value to 45, and then press  to save the change.



Figure 3-8: Press ▲ ▼ to Change SV; Press ↵ to Save the Change

Technical specifications of the heater can be found in Appendix 5: Temperature Controller Factory Settings.

3.3 Trigger Button and LED

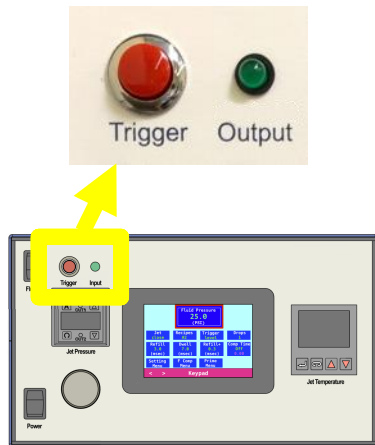

Figure 3-9:
Trigger Button and Output LED

Pressing the **Trigger Button** immediately executes the current recipe based on the recipe number and parameters shown on the Touch Display. If multiple drops were specified in the recipe, multiple drops will be dispensed.

The **Trigger Output LED** is illuminated when the Jet is firing to verify a signal was sent to the Jet. The light is off when the Jet is in the idle state.

3.4 Main Power Switch

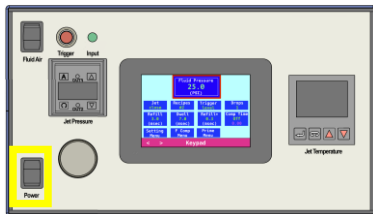

Figure 3-10:
Jet and Fluid Pressure Regulators

The controller main power switch is on the lower left corner of the front panel.

4. HV-2100C Touch Display Operation

4.1 Using the Touch Display

HV-2100C front panel programming and operation uses the LCD Touch Display, highlighted in Figure 4-1.

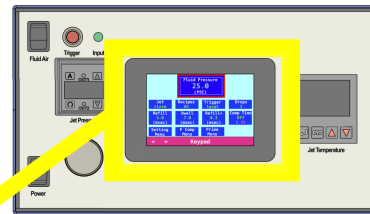
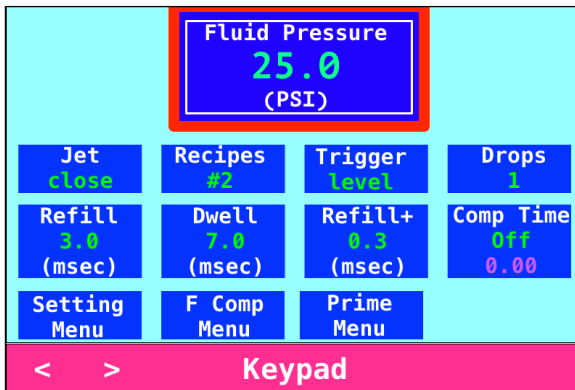

Figure 4-1: LCD Touch Display



The home screen displays the actual fluid pressure, jet status, dispensing recipe number, and the current parameters for that recipe, as shown in Figure 4-2.

Figure 4-2: Touch Display Home Screen

- Tap and release the Touch Display to select a field (do not press and hold).
- The selected field is outlined in red, as shown in Figure 4-3.



Figure 4-3: Selected Field is Highlighted in Red

For parameters with fixed values, like **Jet** (OPEN/CLOSE), tap the center of < > to toggle between the values.



Figure 4-4: Tap < > to Toggle Between Values

For parameters with multiple fixed values, such as **Recipes** (#1 - #6), tap the parameter and then tap the center of < > to cycle through the available values.

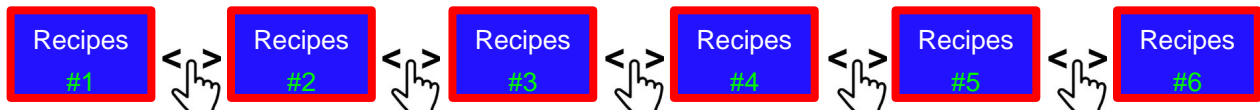
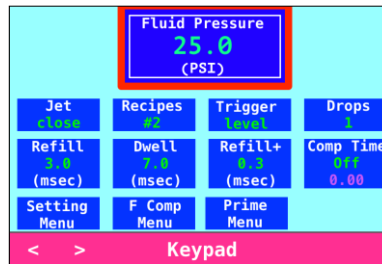

Figure 4-5: Tap < > to Cycle Through the Values

4.1 Using the Touch Display, continued

When a parameter with numerical values is selected, like Fluid Pressure, the keypad option is displayed, offering two ways to enter/change values:



Adjust by Increments:



To quickly fine-tune, tap the parameter and then tap < or > to change the current value by one increment per tap.

For example, tap Fluid Pressure and tap > to increase the value by one increment per tap. For Fluid Pressure, one increment is 0.1 psi.

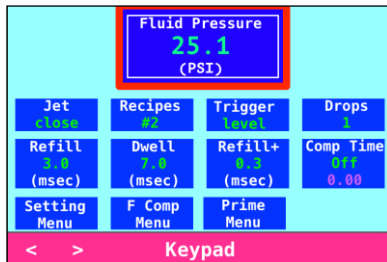

Enter New Value:



To enter a specific value, tap **KEYPAD** to bring up the numeric keypad. The current parameter and value are

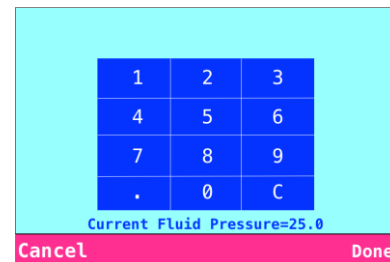

displayed.

Entries are displayed above the keypad. Tap **CANCEL** to exit without saving, or tap **DONE** to save and return to the home screen.

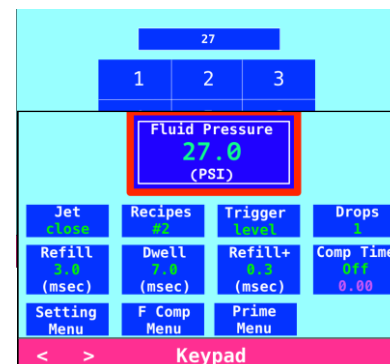

4.2 Home Screen

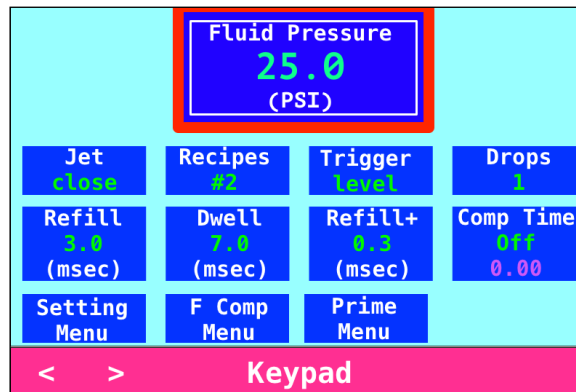

Figure 4-6: HV-2100C Home Screen

FLUID PRESSURE: Sets and displays the pressure for the fluid syringe. Fluid pressure is displayed in psi (default) or MPa (change in the **Settings Menu**). Fluid pressure is normally between 10 and 50 psi; a good starting point is 20 psi. Tap < or > to change in increments or tap **Keypad** to enter a new value.

JET: Jet valve status (OPEN or CLOSE). Tap **Jet** and < or > to CLOSE or OPEN the Jet valve.

RECIPE: Current dispensing Recipe number. Up to six dispensing recipes can be programmed and saved in the controller. Each recipe stores the Trigger mode, Refill time, Dwell time, the number of Drops to dispense, Fluid Pressure, Fluid Compensation settings, and Refill+ time. Tap **Recipes** and < > to cycle through the recipe numbers.

TRIGGER: Current Trigger mode (PULSE or LEVEL). The Trigger is the signal to fire the jet. Tap **Trigger** and < or > to toggle between PULSE and LEVEL mode.

PULSE mode: When the Trigger is in PULSE mode, the jet dispenses the number of drops specified in the **Drops** setting. For example, to dispense 5 drops, set **Trigger** to PULSE and **Drops** to 5.

LEVEL mode: When the Trigger is in LEVEL mode, the jet dispenses drops nonstop until the **Trigger** signal is removed. In LEVEL mode, the drop count is ignored. LEVEL mode can be used to dispense lines (see Appendix 2-5: LINE Mode Programming).

During normal operation, the Trigger signal is toggled by I/O. Pressing the **Trigger** button fires the jet manually, which is useful during setup and programming. When the **Trigger** button is pressed in PULSE mode, the jet dispenses the number of drops specified in **Drops**. Pressing the **Trigger** button in LEVEL mode overrides the LEVEL Trigger mode, and the jet dispenses the number of drops specified in **Drops**, as it does in PULSE mode.

4.2 Home Screen, continued

DROPS: Specifies the number of drops to be dispensed per trigger signal. To dispense a single drop per trigger signal, enter 1. To dispense 10 drops per trigger signal, enter 10. Tap **Drops** and then tap < or > to adjust the drop count by one drop, or tap **KEYPAD** to enter a new value.

REFILL: Refill time is the time that the jet is OPEN. **Refill** time is in msec with 0.1 msec resolution. Tap **Refill** and < or > to change **Refill** time by 0.1 msec or tap **Keypad** to enter a new value. Appendix 2: Timing Recipes provides a detailed explanation of Refill Time.

DWELL: Dwell time is the time that the jet is CLOSED. **Dwell** time is in msec with 0.1 msec resolution. Tap **Dwell** and < or > to change **Dwell** time by 0.1 msec or tap **Keypad** to enter a new value. Appendix 2: Timing Recipes provides a detailed explanation of Dwell Time.

REFILL+: Sometimes the jet requires a little extra time for the first drop to be ejected, perhaps due to the material, or because the jet has been idle for a period of time. The Refill+ setting handles this requirement by adding to the **Refill** time to adjust the size and quality of the first drop. In PULSE mode, **Refill+** time applies to each drop; in LEVEL mode, **Refill+** time applies to just the first drop.

Tap **Refill+** and < or > to change **Refill+** time by 0.1 msec or tap **Keypad** to enter a new value. Refer to Section Appendix 2: Timing Recipes and also Appendix 3: First Drop Compensation.

4.2 Home Screen, continued

COMP TIME: If a Fluid Compensation program has been saved, tapping **Comp Time** and < > brings up the Fluid Compensation Start screen.

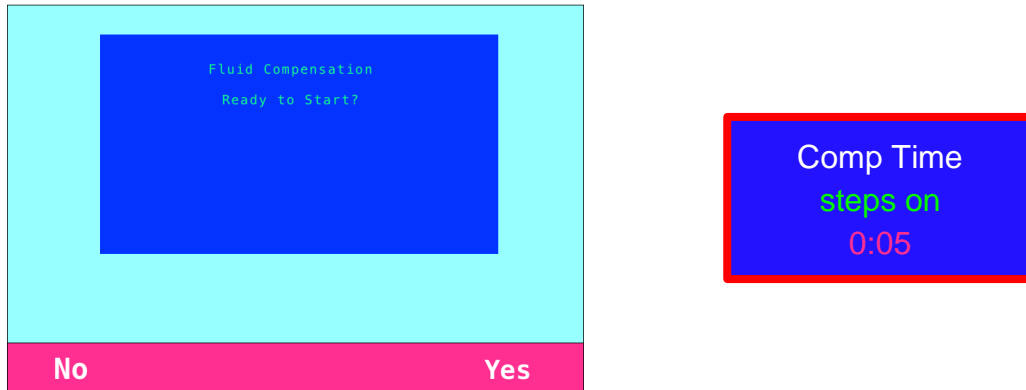

Figure 4-7: Fluid Compensation Start Screen

Tap **No** to cancel or press **Yes** to start the timer. When started, the **Comp Time** field on the Home Screen shows the Fluid Compensation mode (Steps or Linear), status (On), and the elapsed time.

To turn Fluid Compensation off, tap **Comp Time** and < >. The Fluid Compensation Stop screen prompts for a confirmation:

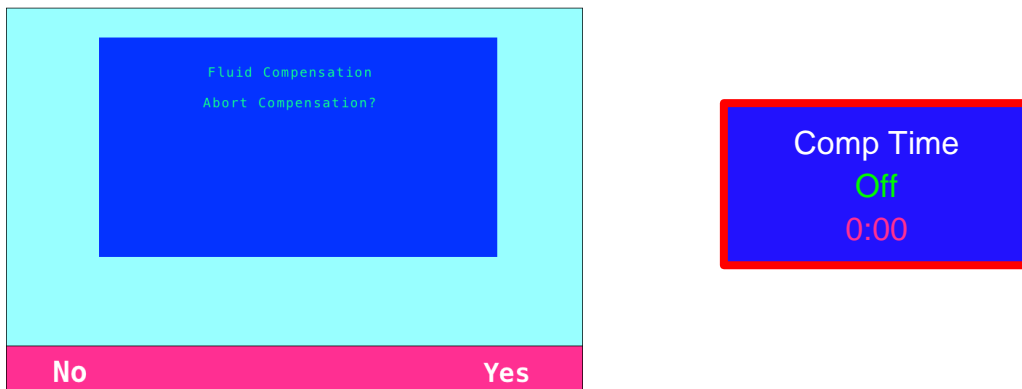

Figure 4-8: Fluid Compensation Stop Screen

Tap **No** to cancel or press **Yes** to turn Fluid Compensation off. The Comp Time field on the Home Screen shows status Off, and the elapsed time is reset to zero.

4.3 Setting Menu

On the Home screen, tapping **Setting Menu** brings up the Settings screen. Advanced jetting parameters and controller settings are input from the Settings screen.

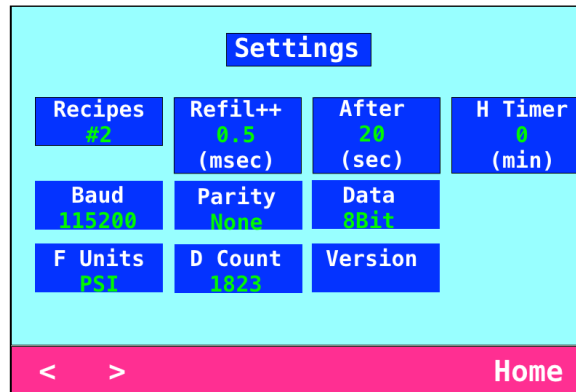

Figure 4-9: Settings Screen

RECIPES: Current jetting recipe number. Tap **Recipes** and < or > to change Recipes.

REFILL++: As another method of first drop compensation, **Refill++** time is added to **REFILL** time only after the jet is idled for a defined number of seconds. **Refill++** time applies to just the first drop in both PULSE and LEVEL modes. Tap **Refill++** and < or > to change Refill++ time by 0.1 msec or tap **Keypad** to enter a new value.

Note: **REFILL++** time requires a value for **AFTER** time.

AFTER: As a part of the **Refill++** time, this parameter specifies the amount of jet idle time associated with the **Refill++** first drop compensation. **Refill++** time is added to **Refill** time after the jet has been idled for specified seconds of **After** time. Tap **After** and < or > to change **After** time by 1 second or tap **Keypad** to enter a new value. Refer to

Appendix 2-2: - Programming Timing Recipes (Adjust Refill Time for First Drop), and also Appendix 3: First Drop Compensation for a detailed explanation.

H TIMER: The Heater Off timer automatically turns off the heater after the Jet has been idle for the specified number of minutes. This feature is useful if materials will be adversely affected by long periods of heating. For example, some materials can be “cured” by high temperature while sitting in the nozzle chamber for a long period of idle time. Tap **H Timer** and < or > to change **H Timer** time by 1 minute. If **H Timer** is set to zero, the Heater Off timer is not activated.

4.3 Setting Menu, continued

RS-232C Settings (Baud, Parity, Data): The default settings for the RS-232C data interface are Baud Rate 115200, Parity NONE, and Data Length 8BIT. To change the default RS-232C settings, tap a setting and < > to cycle through the available values:

Baud 115200 (default), 57600, 19200, 9600, or 4800
Parity NONE (default), EVEN, or ODD
Data 8BIT (default) or 7BIT

The RS-232C Settings are explained in detail in Appendix 1: RS-232C Communication.

F UNITS: By default, the HV-2100C displays Fluid Pressure in psi. To change between psi and MPa, tap **F Units** and < >.

D COUNT: Dot Count shows the number of drops dispensed since the last reset. To reset the Dot Count, tap **D Count** and < >. The Dot Counter screen prompts for a confirmation, as shown at right.

Tap **No** to cancel or press **Yes** to clear the Dot Counter.

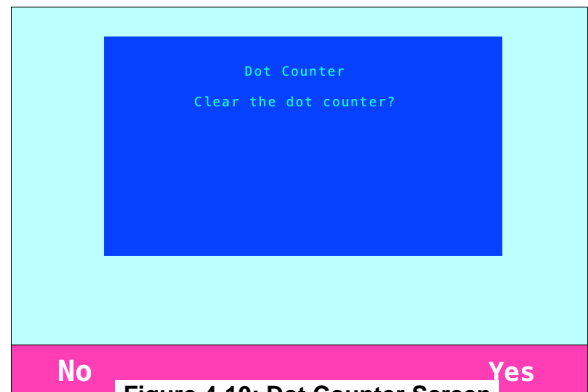

VERSION: Tap **Version** to display the HV-2100C firmware version. The lifetime drop count for the controller is also displayed. This drop count cannot be reset.

Tap **Exit** to return to the **Settings** menu.

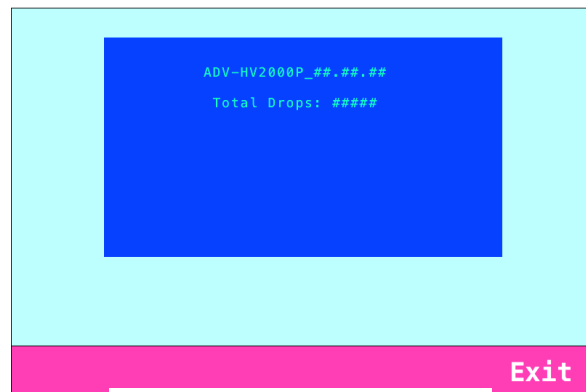

4.4 Fluid Pressure Compensation Menu

Fluid Pressure Compensation can provide more consistent dispensing of fluids that change viscosity over the life of the syringe. To maintain consistent dispensed dot weight or line width, fluid pressure can be increased. For example, line width might be perfect at 30 psi with a new syringe installed. But after an hour, 30.5 psi is required to achieve the same results. After another hour, 31.5 psi is required, then 33, and then another psi every half hour. By the time the syringe is empty at 4.5 hours, fluid pressure is up to 35 psi.

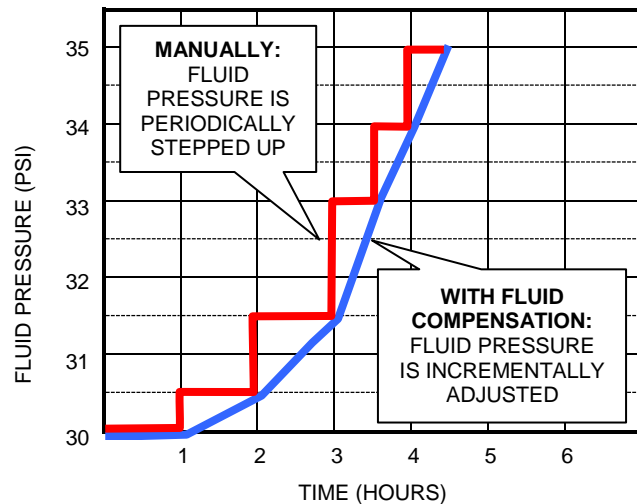

The pressure curve for this example is shown in the graph at left. The red path of large stair-steps represents the jumps in fluid pressure every hour.

The smoother blue path shows the advantage of using Fluid Compensation. The parameters in the compensation menu make the necessary adjustments incrementally over the specified interval. As a result, pressure increases are distributed gradually and in a manner that more closely corresponds to the changing

Figure 4-12: Fluid Pressure Adjusted Over Time viscosity of the fluid.

The HV-2100C offers two options for fluid pressure compensation— Linear or Steps.

Linear: Dispensing starts at the specified minimum fluid pressure and ends at the specified maximum fluid pressure over a specified number of hours, resulting in a linear increase in fluid pressure over time.

Steps: Dispensing starts at the specified minimum fluid pressure, and then fluid pressure increases can be specified for each successive hour, for up to 12 hours or until the specified maximum fluid pressure is reached.

To add Fluid Pressure Compensation to a dispensing recipe, start from the Home Screen and verify that the desired number is displayed in the Recipes field. Tap **F Comp** to bring up the Fluid Compensation Menu. Tap **Option** and **< >** to switch between **Linear** and **Steps**.

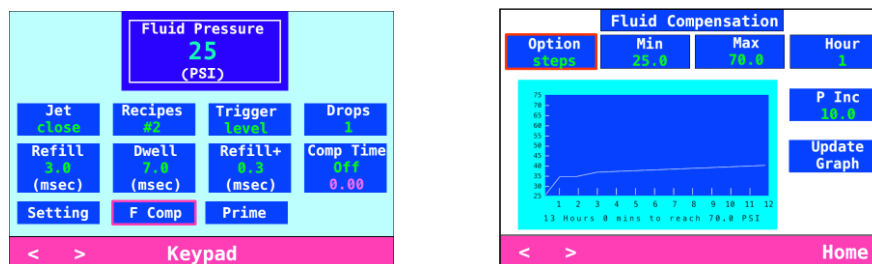

Figure 4-13: Tap F Comp for the Fluid Compensation Menu; Tap Option and < > to Select Linear or Steps

4.4 Fluid Pressure Compensation Menu, continued

Linear Option

OPTION: Tap **Option**, and then tap < > if necessary to display **Linear**. The values for the last program used are displayed.

MIN: Minimum Fluid Pressure is the value at the start of dispensing, displayed in psi or MPa as selected in the Settings Menu. Tap **Min**, and then tap < or > to change the current value by increments; tap **Keypad** to enter a numerical value.

MAX: Maximum Fluid Pressure is the maximum pressure. Tap **Max**, and then tap < or > to change the current value by increments; tap **Keypad** to enter a numerical value.

HOUR: Number of hours to reach **Max** pressure. To input the **Hour** number, tap **Hour** and < > to go up or down by an hour; tap **Keypad** to enter an hour number from the keypad.

UPDATE GRAPH: As Pressure Increase is programmed for each hour, the graph shows fluid pressure over time, and the number of hours to reach Max pressure. Tap to refresh the graph.

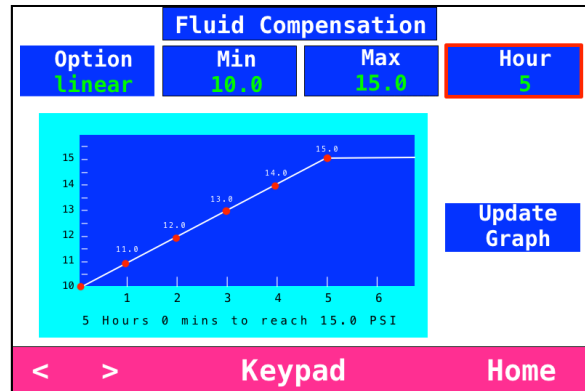

Figure 4-14: Fluid Compensation - Linear Option

4.4 Fluid Pressure Compensation Menu, continued

Steps Option

OPTION: Tap **Option**, and then tap < > if necessary to display **Steps**. The values for the last program used are displayed.

MIN: Minimum Fluid Pressure is the value at the start of dispensing, displayed in psi or MPa as selected in the Settings Menu. Tap **Min**, and then tap < or > to change the current value by increments; tap **Keypad** to enter a numerical value.

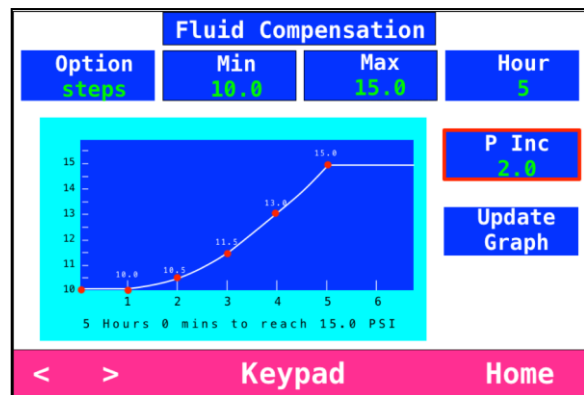

Figure 4-15: Fluid Compensation - Steps Option

MAX: Maximum Fluid Pressure is the maximum pressure. Tap **Max**, and then tap < or > to change the current value by increments; tap **Keypad** to enter a numerical value. After the hourly increases bring fluid pressure to **Max**, fluid pressure remains at **Max**, even if additional increases have been programmed that might have exceeded the maximum. On the other hand, **Max** may not be reached if the cumulative increases are less than the difference between **Min** and **Max**.

HOUR: Number of hours after start (whole hours from 1 to 12). The steps from **Min** to **Max** are defined by the hourly increases. To input the **Hour** number, tap **Hour** and < > to go up or down by an hour, or tap **Keypad** to enter an hour number from the keypad.

P INC: Pressure Increase is the amount by which Fluid Pressure is increased for the hour number shown in the **Hour** field. Tap **P Inc** and < or > to increase by increments; tap **Keypad** to enter a numerical value.

As shown at right, the keypad screen displays the current value for **P Inc** and the **Hour** number as a reminder. To hold a selected fluid pressure for an extended time, set **P Inc** to 0.0 for each of those hours.

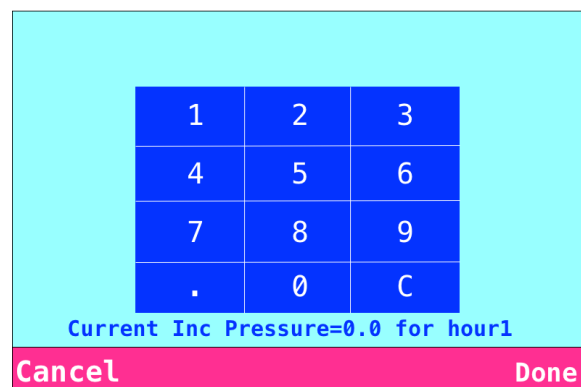

Figure 4-16: Keypad Screen

UPDATE GRAPH: As Pressure Increase is programmed for each hour, the graph shows fluid pressure over time, and the number of hours to reach Max pressure. Tap to refresh the graph.

4.5 Compensation Menu Example

In this example, prior testing data for a particular material found that it requires a minimum of 10 psi and a maximum of 15 psi in order to achieve a consistent weight over a period of five hours. It was determined that fluid pressure required no change over the first hour; 0.5 psi increase by the end of the second hour; 1.0 psi increase by the end of the third hour; 1.5 psi increase by the end of the fourth hour; and 2.0 psi increase by the end of the fifth hour.

Linear Option

To set this psi profile as a Fluid Pressure Compensation Linear Program, enter the values for **Min** pressure, **Max** pressure, and **Hour** as shown.

Min Pressure	Max Pressure	Hour
10.0	15.0	5

The graph on the Fluid Compensation screen shows the pressure curve:

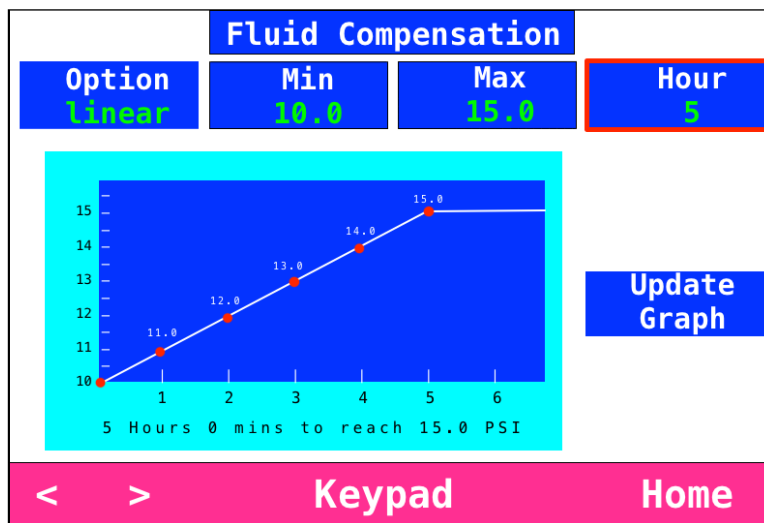

Figure 4-17: Pressure Curve for Sample Linear Program

4.5 Compensation Menu Example, continued

Steps Option

To set this psi profile as a Fluid Pressure Compensation Steps Program, enter the Fluid Compensation Menu values as shown. Note that **Min** and **Max** are the same for every hour—in this example, **Min** is always 10.0 psi and **Max** is always 15.0 psi.

Time	Hour	P Inc	Fluid Pressure
Start	Hour = 0		Min Fluid Pressure = 10.0 psi
End of 1 st hour	Hour = 1	P Inc = 0.0 (no change)	Fluid Pressure = 10.0 psi
End of 2 nd hour	Hour = 2	P Inc = 0.5	Fluid Pressure = 10.5 psi
End of 3 rd hour	Hour = 3	P Inc = 1.0	Fluid Pressure = 11.5 psi
End of 4 th hour	Hour = 4	P Inc = 1.5	Fluid Pressure = 13.0 psi
End of 5 th hour	Hour = 5	P Inc = 2.0	Fluid Pressure = 15.0 psi (Max)

The graph on the Fluid Compensation screen shows the pressure curve:

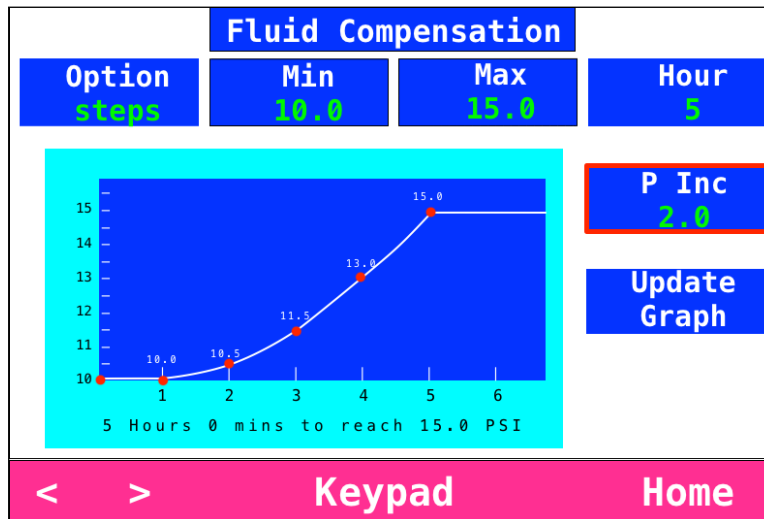

Figure 4-18: Pressure Curve for Sample Steps Program

4.5 Compensation Menu Example, continued

When Fluid Compensation is ON, the Home Screen shows the Fluid Compensation status and elapsed time. The **Fluid Pressure** and **Comp Time** fields are updated every minute. Note that the **Comp Time** field shows how many full hours since the start of fluid compensation, so the first hour of dispensing is zero.

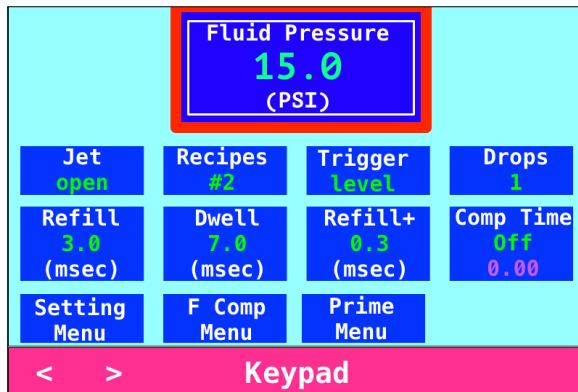

Figure 4-20: Compensation Turns OFF When Fluid Pressure Reaches Maximum

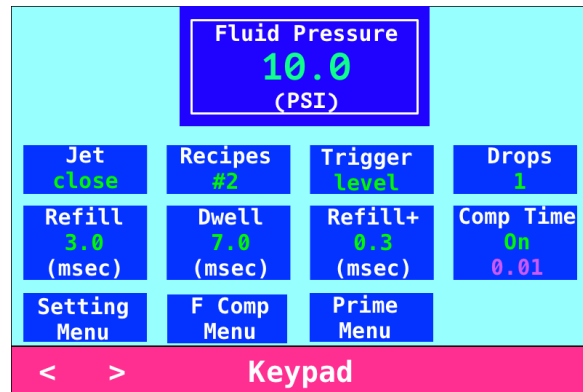
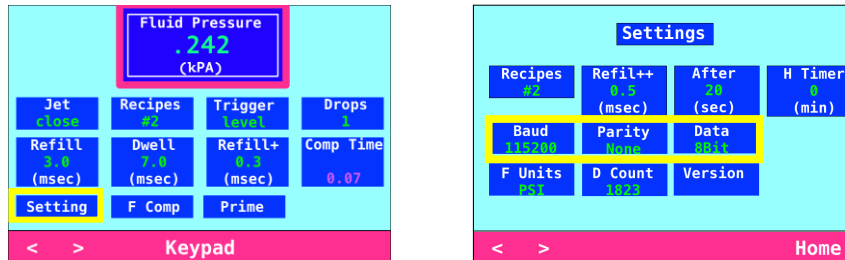

Figure 4-19: Home Screen Shows Fluid Compensation Status and Elapsed Time

Fluid Compensation is automatically turned off when fluid pressure reaches the maximum psi specified in the program—in this example, when it reaches 15.0 psi after five hours. Fluid Pressure will remain at that maximum level.

Appendix 1: RS-232C Communication

The default settings for the RS-232C data interface are Baud Rate 115200, Parity NONE, and Data Length 8BIT. To change the default RS-232C settings, tap **Setting** from the home screen to bring up the Settings screen.



From the Settings screen, tap **Baud**, **Parity**, or **Data** to cycle through the available values:

Baud	115200 (default), 57600, 19200, 9600, or 4800
Parity	NONE (default), EVEN, or ODD
Data	8BIT (default) or 7BIT

The following table shows the RS-232C cable pin-outs when connecting directly from a PC serial port:

RS-232C Connector Pins		
Computer	Advanjet Controller	Function
2	3	Rx ← Tx
3	2	Tx → Rx
4	6	--
5	5	GND
6	4	--
7	8	--
8	7	--

Appendix 2: Timing Recipes

Before dispensing can begin, Timing Recipes must be created for the particular fluids being dispensed.

Appendix 2-1: Recipe Time Parameters

A Recipe specifies two timers, Refill Time and Dwell Time, which set the performance of the jet and the size and volume of the jetted drop. The values for Refill Time and Dwell Time depend on the rheology of the fluid to be dispensed and should be chosen to optimize jet performance and dispense quality.

Refill Time is the time that the jet is OPEN. The amount of refill time is dependent on viscosity, temperature, and fluid pressure. For example, for a UV adhesive with 1,000 cps, a typical **Refill** time might be from 1.7 to 2 msec with fluid pressure at 15 psi. It is best to determine the **Refill** time through application testing. Too much **Refill** time could cause accumulation of material on the nozzle tip. Not enough **Refill** time could result in a poor-quality drop or a missed drop.

Specifically, without sufficient **Refill** time, the jet will be “starved” and the drop size could be inconsistent. A pattern of large and small drops is usually a sign that the jet needs more time to refill. If this pattern is observed, increase the value of **Refill** time until the drops are consistent and stable. Alternatively, if a specific drop rate is desired, increase **Fluid Pressure** instead of **Refill** time.

Dwell Time is the time that the jet is CLOSED. In DROP mode, the value of **Dwell** time is usually not important since its duration is small compared to the motion time of the robot moving from one position to the next. However, in LINE mode, the **Dwell** time is important and sets the drop cycle time.

Drop Cycle Time: The following formula gives the relationship of drop cycle time, drop spacing, and robot velocity:

$$V = \Delta X / \Delta T$$

Where V = Robot Velocity
 ΔX = Desired Drop Spacing
 ΔT = Drop cycle time (Refill Time + Dwell Time).

Refill+ and **Refill++** time: Refill time can be extended to give the jet a little extra time for the first drop to be ejected. This is useful with materials that are “shear thinning” and/or need a little extra time initially after being idle for a period of time. In either the DROP mode or LINE mode, the extra time is added to the Refill Time to adjust the time for the first drop.

Appendix 2-2: Programming Timing Recipes

Recipe List: Up to six recipes can be programmed.

Refill Time: Sets the jet OPEN time, which is the time required for the material to flow into the orifice after each drop has been ejected. Time is set in milliseconds with 0.1 msec resolution.

Dwell Time: Sets the jet CLOSED time, which is the time required for the material to be ejected from the orifice. Time is set in milliseconds with 0.1 msec resolution.

Adjust Refill Time for First Drop: There are add-on times for adjusting the size and quality of the first drop.

Refill+ field on the controller Home Screen

Add XX msec is a time value that is added to Refill time.

For example:

$$\begin{aligned} & 2.0 \text{ msec original Refill time} \\ + & 0.5 \text{ msec additional Refil+ time} \\ = & 2.5 \text{ msec total Refill time} \end{aligned}$$

In DROP mode, this value is added to every drop (see Appendix 2-4: DROP Mode Programming). However, in LINE mode this value is added only to the very first drop.

Refill++ field on the controller Home Screen

Add XX msec after YY seconds is a time value added to Refill time after the jet is idled for a defined number of seconds. This additional time is added only to the first drop in both DROP and LINE mode. In general, the value of **Refill++** is slightly larger than **Refill+**. Continuing the previous example, setting a **Refill++** time of 0.8 msec for the first drop after 20 seconds at idle would be:

$$\begin{aligned} & 2.0 \text{ msec original Refill time} \\ + & 0.8 \text{ msec additional Refill++ time} \\ = & 2.8 \text{ msec total Refill time—this applies to only the first drop} \end{aligned}$$

Appendix 2-3: Trigger Map

The Trigger Map shows the assignment of the trigger input to the dispensing recipes. For instance, input trigger signal from I/O Pin 1 is used to activate Recipe #1. The BusyFlag (I/O Pin 7) is an output signal that the controller/robot can use to monitor the Jet status. When the Jet is idle, the BusyFlag signal is set to high; when the Jet is activated, the BusyFlag signal is set to low. The controller/robot can use the BusyFlag signal to synchronize the timing for the next Recipe trigger.

TRIGGER MAP		
Recipe #1 Trigger	←	I/O Pin 1
Recipe #2 Trigger	←	I/O Pin 2
Recipe #3 Trigger	←	I/O Pin 3
Recipe #4 Trigger	←	I/O Pin 4
Recipe #5 Trigger	←	I/O Pin 5
Recipe #6 Trigger	←	I/O Pin 6
Busy Flag	→	I/O Pin 7

Appendix 2-4: DROP Mode Programming

Programming the Advanjet system is very simple and flexible, as shown in the following examples.

Example 1: Dispensing one drop at a time

1. On the controller home screen, tap **Recipes** and < or > to display the settings for Recipe #1.
2. Tap **Drops** and enter 1.
3. Tap **Trigger** and select **Pulse** mode.
4. Single drops are dispensed at the designated locations:
 - The robot moves to an X-Y position.
 - The robot sends a trigger signal on I/O Pin 1 to jet a drop.
 - The robot moves to another X-Y position.
 - The robot sends a trigger to jet a drop, and so on.

Example 2: Dispensing multiple drop sizes

1. On the controller home screen, tap **Recipes** and < or > to display the settings for “Recipe #1.”
2. Tap **Drops** and enter 1.
3. Tap **Trigger** and select **Pulse** mode.
4. On the controller home screen, tap **Recipes** and < or > to display the settings for Recipe #2.
5. Tap **Drops** and enter 2.
6. Tap **Trigger** and select **Pulse** mode.
7. Multiple drops are dispensed at the designated locations:
 - The robot moves to an X-Y position.
 - The robot sends one trigger signal on I/O Pin 1 to jet one drop.
 - The robot then moves to another X-Y position.
 - The robot sends one trigger signal on I/O Pin 2 to jet two drops.

Alternately, instead of using two recipes, the robot can issue multiple triggers to fire multiple drops.

Appendix 2-5: LINE Mode Programming

Advanjet controllers make dispensing lines very simple. The following examples illustrate how this is done.

Example 1: Jetting a line in PULSE mode

1. On the controller home screen, tap **Recipes** and < or > to display the settings for Recipe #1.
2. Tap **Refill** and enter **2** msec; tap **Dwell** and enter **3** msec. (The timing is given here for illustration; optimal timing for fluid and pressure varies with material.)
3. To dispense 60 drops in the line, enter 60 for Drops and set Trigger to Pulse.
4. For this example, the desired ΔX (drop spacing) is 0.5 mm and ΔT (drop cycle time, which is Refill + Dwell time) is 5 msec/drop. To calculate the needed velocity (V) of the robot:

$$\begin{aligned} V &= \Delta X / \Delta T \\ &= 0.5 \text{ mm} / 0.005 \text{ sec} \\ &= 100 \text{ mm/sec} \end{aligned}$$

5. The line is dispensed at the designated location:
 - The robot makes an X-Y move at 100 mm/sec and runs Recipe #1 to jet 60 drops. The drops will be spaced on 0.5 mm centers.
 - To achieve smaller drops while maintaining the same velocity and ΔX , change the **Refill** time to 1.7 msec and **Dwell** time to 3.3 msec to keep ΔT at 5 msec.

Example 2: Jetting a line in LEVEL Mode

Level mode lines are programmed by specifying the length of time that the jet dispenses at a specified jet velocity.

1. On the controller home screen, tap **Recipes** and < or > to display the settings for Recipe #3.
2. Tap **Refill** and enter **2** msec; tap **Dwell** and enter **3** msec. The ΔT (refill + dwell time) is 5 msec.
3. Set **Trigger** to **Level**. Note that in Level mode, the controller ignores the Drops setting. Instead, the number of drops dispensed is determined by the (time) duration of the “low” trigger.
4. As determined in the previous example, drop cycle time (ΔT) is 5 msec. For drop spacing (ΔX) of 0.5 mm, robot velocity (V) is calculated as follows:

$$\begin{aligned} V &= \Delta X / \Delta T \\ &= 0.5 \text{ mm} / 0.005 \text{ sec} \\ &= 100 \text{ mm/sec} \end{aligned}$$

Appendix 2-5: LINE Mode Programming, continued

5. The line is dispensed at the designated location:
 - The robot makes an X-Y move at 100 mm/sec and runs Recipe #3.
 - To jet 60 drops at the prescribed drop rate, this trigger signal should stay low for 300 msec (60 drops × 5 msec drop cycle time).
 - To dispense smaller drops at the same robot velocity and drop spacing, decrease **Refill** time to 1.7 msec and increase **Dwell** time to 3.3 msec (drop cycle time remains at 5 msec).

Example 3: Jetting a line during an X-Y move

There is another method to dispense a line if the robot has the capability to issue triggers during an X-Y move. The robot will make an X-Y move and send pulses of trigger to the controller at the position where it wants to jet a drop. The following example illustrates the procedure.

1. On the controller screen, select a **Recipe** number and set **Refill** time to **2.0**, **Dwell** time to **2.8**, **Drops** to **1**, and **Trigger** mode to **Pulse**.
2. The line is dispensed at the designated location:
 - The robot makes an X-Y move.
 - The robot sends a trigger to the controller every 5 msec to form a string of drops.

It is important to not issue a new pulse to the Advanjet controller until the ΔT cycle is completed. Otherwise, the Advanjet controller will ignore the trigger if it hasn't completed its cycle. In this example, **Dwell** time was set to 2.8 msec to ensure the ΔT cycle is completed before the robot issues a new pulse.

Appendix 3: First Drop Compensation

Appendix 3-1: Background

Many viscous fluids are thixotropic and the viscosity decreases with motion. This is often referred to as shear thinning. When dispensing a thixotropic fluid, the very first drop ejected can often be smaller than subsequent drops if the jet has been idle for some time.

Traditionally, operators dispense a few “wasted drops” in a blank area of the substrate to get the dispensing material into a shear-thinning condition. Although this technique is a good idea because it gets rid of the first drop problem altogether, it wastes time and fluid. Advanjet has a better solution.

Appendix 3-2: Calculating First Drop Compensation

To compensate for small first drops, Advanjet controllers offer two jetting parameters: **Refill+** and **Refill++**. The first drop compensation process is based on the following:

T^+ = First Drop Compensation
 T^{++} = Extended Drop Compensation
Elapse Time = Idle time of the jet since the last dispense
Extended Timeout = Time entered in the Recipes Menu/Adjust Refill Time
for first drop “msec after YY seconds”

If Elapse Time < Extended Timeout, then Refill Time = Refill + T^+
If Elapse Time > Extended Timeout, then Refill Time = Refill + T^{++}

Examples: For a time-cure material, the fluid could be slightly thickening if it sits idle for a long time, especially if the fluid is being actively heated. Suppose Extended Timeout is set at 20 seconds. The first drop refill time will equal (Refill + T^*), where the value of T^* depends on how long the jet has been idle.

If Elapse Time < 20 sec (Extended Timeout), then $T^* = T^+$
If Elapse Time \geq 20 sec (Extended Timeout), then $T^* = T^{++}$

Lines: For the first drop of all the lines, Refill Time = Refill + T^{++} . Subsequent drops will have a Refill Time without any compensation if multiple drops are specified.

Individual Drops: For individual drops, Refill Time = Refill + T^+ . When dispensing individual drops with an Elapse Time of less than 20 seconds, the compensation is always applied.

Appendix 3-3: First Drop Compensation in PULSE Mode

- In this mode, the controller produces “n” drops when it receives a trigger signal, where “n” is the number of drops.
- Refill Time for the first dot = Refill + T^+
- Refill Time for all subsequent dots = Refill (no added first drop compensation)
- If the number of drops is set to 1, the refill time will always be Refill + T^+ because there are no subsequent dots.

Example 1: Number of drops = 1

In the timing diagram, $T^* = T^+$
Therefore, each drop = Refill + T^+

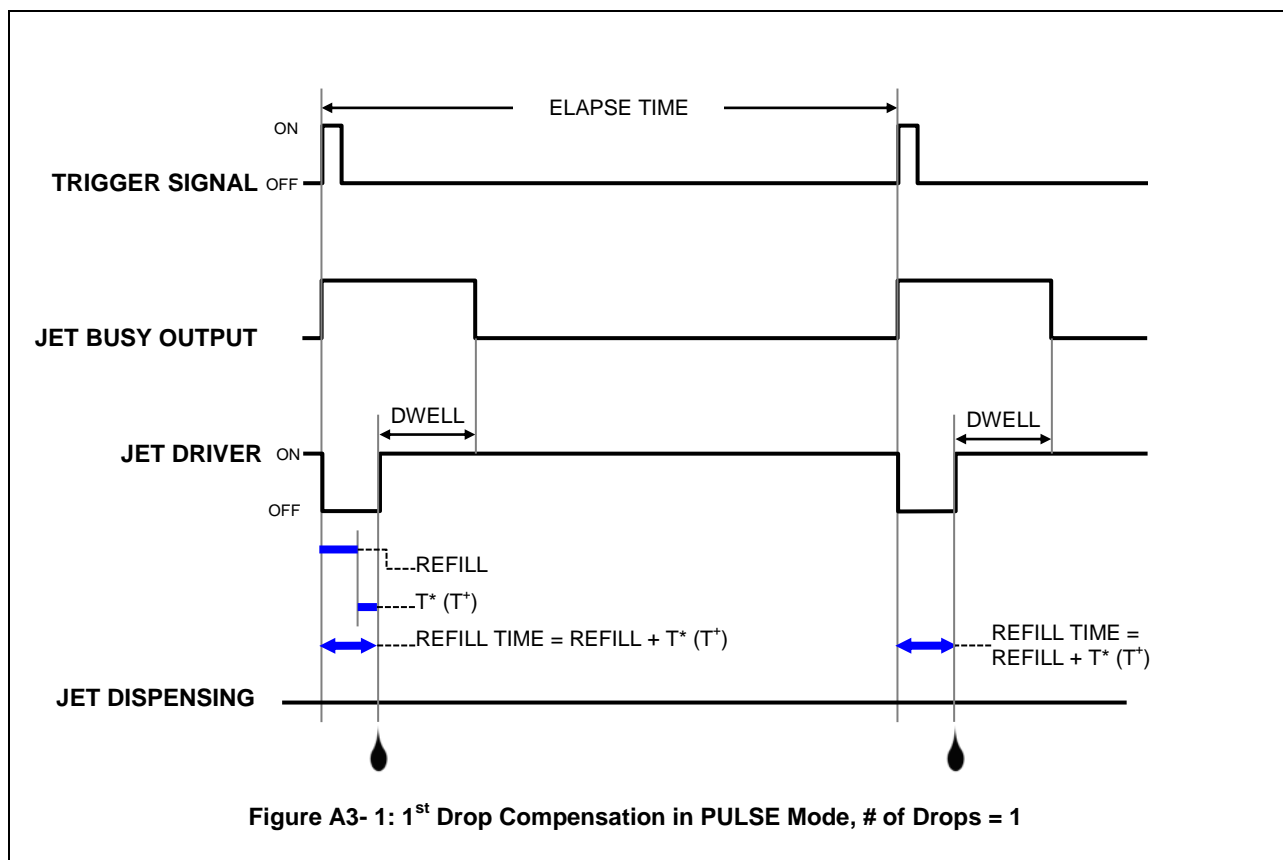

Appendix 3-3: First Drop Compensation in PULSE Mode, continued

Example 2: Number of drops = 3

In this timing diagram, $T^* = T^+$

Therefore, the first drop = Refill + T^+

The refill time for all other drops = Refill (no first drop compensations added).

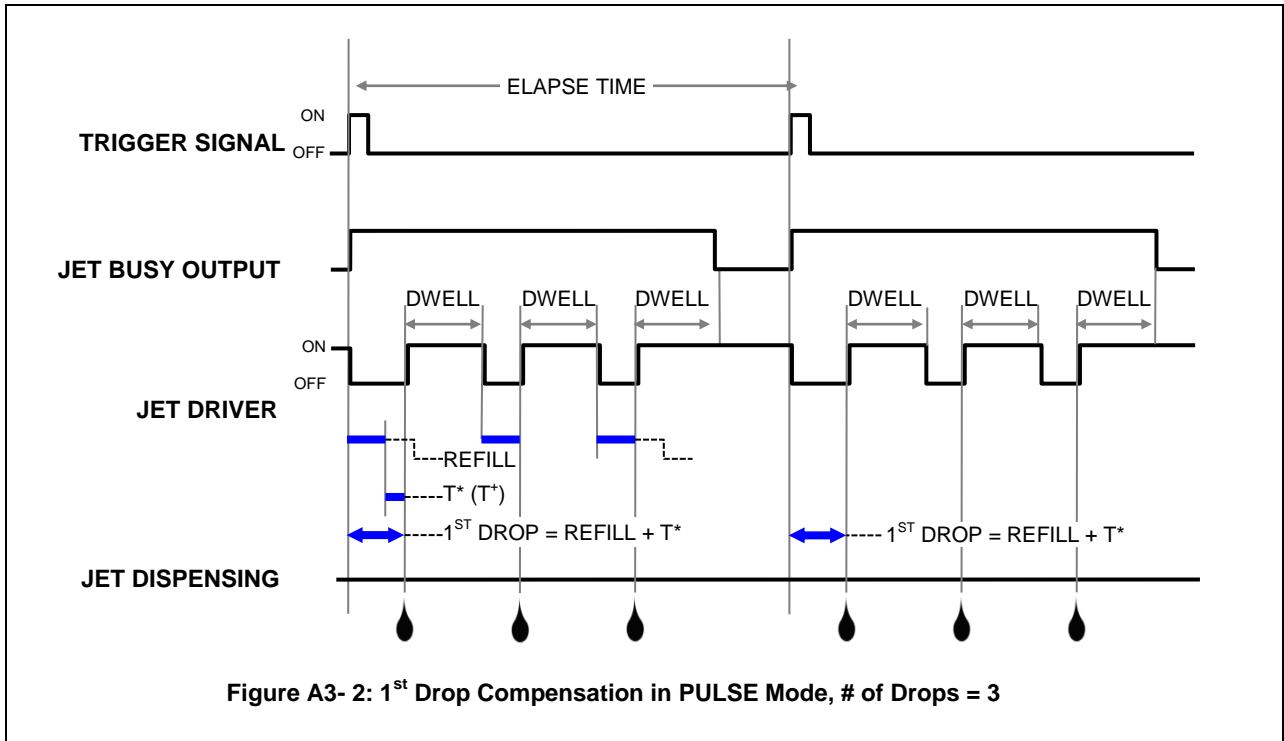

Appendix 3-4: First Drop Compensation in LEVEL Mode

- In this mode, the controller produces drops as long as the Trigger signal is high
- Refill Time for the first dot = Refill + T^*
- Refill Time for all other dots = Refill

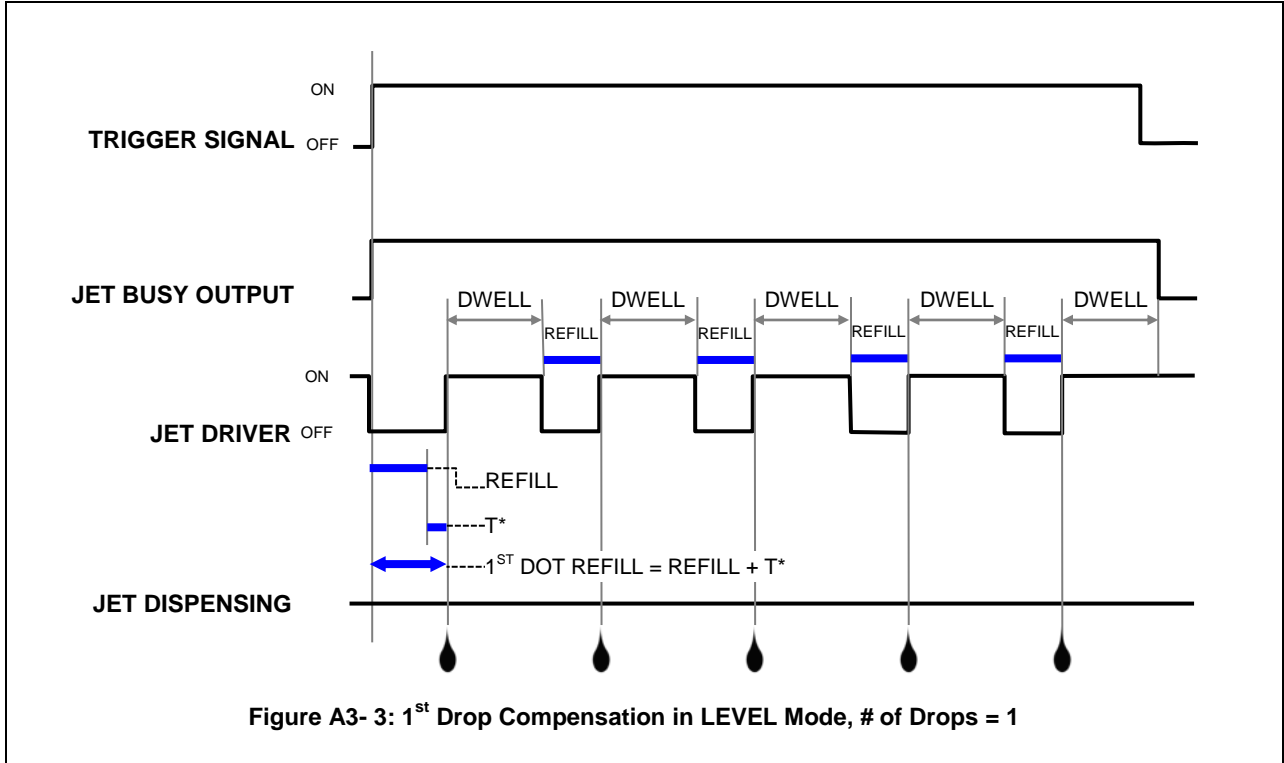

Appendix 4: Advanjet Controller Commands (ACC)

The ACC is a simple set of commands for controlling the Jet, timing values, and settings for the recipes. A host computer or external robot connects to the Advanjet controller via an RS-232C cable and sends ACC to the controller in ASCII format. This section is a reference for using ACC to write a custom program for the Controller.

ADVANJET CONTROLLER COMMANDS (ACC)		
RECIPE TIMING		
ST	Set Recipe Timers	#RecipeID,#Refill,#0,#0,#0,#0,#Dwell;
SL	Adjust Refill Time for First Drop	#nRecipeID,#Refill+,#Refill++,#DelaySec;
CT	Set Drop Count and Trigger Format	#nRecipeID,#TriggerFormat,#nDotCount;
JETTING		
SM	Select Recipe	# nRecipeID;
SG	Start Dispensing	(no values required)
SV	Set Jet Value State	# nValveID,# nValveStatus;
SD	Reset Internal Drop Counter	# nDropcnt;
PRESSURE		
SU	Set Fluid Pressure	# nFluidPressure;
SA	Turn Vacuum On/Off	# nAirVacuum;
SS	Extend/Retract Height Sensor	# nHeightSensor;
TEMPERATURE		
SH	Set Heater Temperature	# nTemperature;
SO	Turn Heater On/Off	# nFlag;
HF	Heater Off timer	# nMins;
OUTPUT		
OV	Output Version	OV;
OD	Output Internal Drop Counter	OD;
OE	Output Error	OE;
OS	Output Jet Status	OS;
OH	Output Height Sensor Switch	OH;
OL	Output Tactile Sensor Switch	OL;
OU	Output Fluid Pressure	OU;
OT	Output Temperature	OT;

Appendix 4-1: The RS-232C Interface

The controller is connected to the host computer via an RS-232C cable. The default settings for the RS-232C data interface are Baud Rate 115200, Parity NONE, and Data Length 8BIT. To change the default RS-232C settings, tap a setting and < > to cycle through the available values:

Baud 115200 (default), 57600, 19200, 9600, or 4800
Parity NONE (default), EVEN, or ODD
Data 8BIT (default) or 7BIT

Appendix 4-2: Command Format

Each command is identified by two ASCII characters (ST, SL, CT, etc.) and followed by a series of values. A COMMA separates each value and a SEMICOLON must terminate the last value. For example: **CT 0,0,2;** is a valid command. But **CT 0,0,2** is not valid because the controller is looking for a semicolon before executing this command.

Appendix 4-3: Recipe Timing Commands

ST	Set Recipe Timers	#RecipeID,#Refill,#0,#0,#0,#0,#Dwell;
-----------	-------------------	---------------------------------------

The **ST** function configures the timing values for the recipe. #RecipeID numbers 0 to 5 correspond to Recipes 1 to 6.

#RecipeID 0	→	Recipe #1
#RecipeID 1	→	Recipe #2
#RecipeID 2	→	Recipe #3
#RecipeID 3	→	Recipe #4
#RecipeID 4	→	Recipe #5
#RecipeID 5	→	Recipe #6

Seven parameters are required for this function, defined as follows:

1	# nRecipeID	Identifies the recipe; it must be between 0 and 5 .
2	# Refill	Specifies the Refill Time in 0.1 msec units.
3 - 6	#0, #0, #0, #0	Four reserved timer values; they must all be 0 .
7	# Dwell	Specifies the Dwell Time in 0.1 msec units.

Example #1: **ST 0,18,0,0,0,0,32;**

Sets Recipe #1
Refill Time is 1.8 msec
Dwell Time is 3.2 msec

The Refill Time plus the Dwell Time set the single drop cycle time to 5 msec (1.8 + 3.2) resulting in a drop frequency of 200 drops per second.

Example #2: **ST 3,50,0,0,0,0,150;**

Sets Recipe #4
Refill Time is 5 msec
Dwell Time is 15 msec

The Refill Time plus the Dwell Time set the single drop cycle time to 20 msec (5 + 15) resulting in a drop frequency of 50 drops per second.

Appendix 4-3: Recipe Timing Commands, continued

SL	Adjust Refill Time for First Drop	#nRecipeID,#Refill+,#Refill++,#DelaySec;
-----------	-----------------------------------	--

The **SL** command adjusts the Refill Time for the first dot. These values help to control the size and quality of the first dot. Four parameters are required for this function, defined as follows:

1	# nRecipeID	Identifies the recipe; it must be between 0 and 5 .
2	# Refill+	Sets the timing value in 0.1 msec units to be added to the first dot
3	# Refill++	Sets the timing value in 0.1 msec units to be added to the first dot after the Jet is idle for # DelaySec seconds
4	# DelaySec	Sets the Jet idle time used by the #Refill++ in seconds .

Example: **SL 0,2,4,20;**

Sets the first recipe, Recipe #1
 Refill+ Time is 0.2 msec
 Refill++ Time is 0.4 msec
 Idle Time is 20 seconds

The Refill+ Time (0.2 msec) is added to the Refill Time of Recipe #1 for every drop in DROPP mode but added only to the very first drop in LINE mode. If the Jet has been idle for more than 20 seconds, then the Refill++ Time (0.4 msec) is used for first drop adjustment.

CT	Set Drop Count and Trigger Format	#nRecipeID,#TriggerFormat,#nDotCount;
-----------	-----------------------------------	---------------------------------------

The **CT** command set the count value for drops and the format for the trigger input. Three parameters are required for this function, defined as follows:

1	# nRecipeID	Identifies the recipe; it must be between 0 and 5 .
2	# TriggerFormat	Sets #TriggerFormat; 0 = PULSE and 1 = LEVEL
3	# nDotCount	Sets the number of drops per trigger signal

Example #1: **CT 0,0,2;**

Sets the first recipe, Recipe #1
 Trigger format is PULSE
 Drop Count is 2.

This command will cause the Jet to dispense 2 drops when it receives a PULSE signal from Recipe #1 Trigger.

Example #2: **CT 1,1,5;**

Sets the second recipe, Recipe #2
 Trigger format is LEVEL

The number of drops will depend on the duration of the LEVEL signal (low) from Recipe #2 Trigger and the single drop cycle time defined by the ST command. The drop count value of 5 is ignored.

Appendix 4-4: Jetting Commands

SM	Select Recipe	# nRecipeID;
-----------	---------------	--------------

The **SM** command identifies the recipe that the controller should use when it receives a **SG** (start dispensing) command from the host/robot. This command should be sent before an **SG** command to identify the recipe timers and settings.

# nRecipeID	Identifies the recipe; it must be between 0 and 5 .
-------------	--

Example: **SM 3;** selects Recipe #4

SG	Start Dispensing	(no values required)
-----------	------------------	----------------------

The **SG** command will cause the controller to activate the Jet. The SM command must be used to identify the recipe for timing values and the number of drops to dispense. The SG command must be followed by a semicolon.

Example: A sequence of commands is sent to the controller to program Recipe#1 and Recipe#2 before dispensing:

```
ST 0,50,0,0,0,0,100;  
SL 0,2,4,20;  
CT 0,0,1;  
ST 1,50,0,0,0,0,150;  
SL 1,2,4,20;  
CT 1,0,2;
```

The **CT** command sets one drop to dispense for Recipe#1 and two drops for Recipe#2. When the external host moves to an XY position, it might send the following commands to dispense one drop using the values setup in Recipe#1:

```
SM 0;  
SG;
```

The host then moves to another XY position and sends another **SG;** command to dispense another drop at the new location. It can keep on doing this as long as it is using the values in Recipe#0. If the host decides to dispense 2 drops at the new location, it should send an **SM 1;** command to select Recipe#1 before issuing a **SG;** command.

Appendix 4-4: Jetting Commands, continued

SV	Set Jet Value State	# nValveID,# nValveStatus;
-----------	---------------------	----------------------------

This command allows the host to open or close the Jet valve.

1	# nValveID	Sets # nValveID to 0 for Jet valve
2	# nValveStatus	Sets # nValveStatus; 1 = open and 0 = closed

Example: **SV 0,1;** opens the Jet.

SD	Reset Internal Drop Counter to 0	#nDropcnt;
-----------	----------------------------------	------------

This command is used to reset the internal drop counter to zero

#nDropcnt	Resets the internal drop counter.
-----------	-----------------------------------

Example: **SD 0;** resets the internal drop counter to 0.

Appendix 4-5: Pressure Commands

SU	Set Fluid Pressure	SU,# nPressure;
-----------	--------------------	-----------------

The **SU** command allows the host to set the Fluid Pressure in the Advanjet Controller.

# FluidPressure	Sets fluid pressure in psi .
-----------------	-------------------------------------

Example: **SU,40**; sets fluid pressure to 40 psi.

SA	Turn Vacuum On/Off	SA,# nAirVacuum;
-----------	--------------------	------------------

When using the Advanjet Controller in the B-300 or B-300HM dispensing system, the **SA** command is used to turn the Priming/Purging Station vacuum on or off.

# nAirVacuum	Turns priming station vacuum on or off; 1 = on and 0 = off
--------------	--

Examples: **SA 1**; turns the vacuum ON.
 SA 0; turns the vacuum OFF.

SS	Extend/Retract Height Sensor	SS,# nHeightSensor;
-----------	------------------------------	---------------------

When using the Advanjet Controller in the B-300 or B-300HM dispensing system, the **SS** command is used to extend or retract the height sensor.

# nHeightSensor	Closes/opens height sensor solenoid; 1 = closed (sensor is retracted) and 0 = open (sensor is extended)
-----------------	--

Examples: **SS 1**; retracts the height sensor
 SS 0; extend the height sensor

Appendix 4-6: HV-2100C Heater Commands

SH	Set Heater Temperature	SH # nTemperature;
-----------	------------------------	--------------------

The **SH** command allows the host to set the temperature for the Heater Controller in the Controller.

# nTemperature	Sets temperature value in degrees Celsius . For the HV-2000C, this value should be less than 75 degrees Celsius.
----------------	---

Example: **SH 50;** sets the heater temperature to 50 degrees Celsius.

SO	Turn Heater On/Off	SO # nFlag;
-----------	--------------------	-------------

The **SO** command allows the host to turn the heater in the controller ON or OFF.

# nFlag	Sets #nFlag; 1 = turn heater on and 0 = turn heater off
---------	---

Examples: **SO 1;** turns the heater ON
 SO 0; turns the heater OFF

HF	Heater Off timer	# nMins;
-----------	------------------	----------

The **HF** command gives the host the ability to automatically turn the heater off after a specified Jet idle time.

# nMins	Sets the idle Jet time in minutes
---------	--

Example: The following commands will set the heater temperature to 50 degrees Celsius, the idle time to 5 minutes and turn on the heater.

SH 50;
HF 5;
SO 1;

Appendix 4-7: Output Commands

Note: The controller might not be able to respond to the output commands when it is busy dispensing a long series of drops. In this case, the host should try again after a short wait.

OV	Output Version	OV;
-----------	----------------	-----

The host can send this **OV;** command to identify the controller. For example, a return string of **ADV-HV2100P_xxxx** indicates that the host found the HV-2100C controller.

OD	Output Internal Drop Counter	OD;
-----------	------------------------------	-----

The host can send the **OD;** command to determine the number of drops that have been completed since the last **SD;** command (reset counter command). A return string consisting of the total number of drops will be returned.

OE	Output Error	OE;
-----------	--------------	-----

The host can send the **OE;** command to verify that it is communicating properly with the controller. A return string of **0;** indicates that the command was received without error and **1;** indicates there was an error in the previous command. Once the **OS;** command return string is returned, the error state in the controller is cleared.

OS	Output Jet Status	OS;
-----------	-------------------	-----

The host can send the **OS;** command to verify that it is communicating properly with the controller. A return string of **1;** indicates that the Jet valve is closed and **0;** indicates the valve is opened.

OH	Output Height Sensor Switch	OH;
-----------	-----------------------------	-----

When using the Advanjet Controller in the B-300 dispensing system, the host can send the **OH;** command to verify that it is communicating properly with the controller. A return string of **1;** indicates that the Height Sensor switch has been activated and **0;** indicates the switch has not been activated.

OL	Output Tactile Sensor Switch	OL;
-----------	------------------------------	-----

When using the Advanjet Controller in the B-300 dispensing system, the host can send the **OL;** command to verify that it is communicating properly with the controller. A return string of **1;** indicates that the Tactile Sensor switch has been activated and **0;** indicates the switch has not been activated.

OU	Output Fluid Pressure	OU;
-----------	-----------------------	-----



The host can send the **OU 1;** command to get the present fluid pressure. A return string of **25.0;** indicates the pressure is at 25.0 psi.





OT	Output Temperature	OT;
-----------	--------------------	-----

The host can send this **OT;** command to get the present temperature of the Jet heater. A return string of **50.5;** indicates the temperature is at 50.5 degrees Celsius.

Appendix 5: Temperature Controller Factory Settings

These factory set values have been programmed by Advanjet to work with the HV-2100C controller and the HV-2100 Jet nozzle plate for the majority of applications. It is strongly recommended that users do not modify these values.

Use the ▲▼ keys to adjust values. Press  once to save changes, and then press  again to return to the previous menu.

OPERATION	Description	Setting	Value
Press 	Control Run/Stop setting	r-S	
	Upper-limit alarm 1	AL1H	3
	Lower-limit alarm 1	AL1L	3
	Upper-limit alarm 2	AL2H	3
	Lower-limit alarm 2	AL2L	3
		LOC	off
REGULATION	Description	Setting	Jet
Press  once, then press 	PB (Proportional band)	P	9
	Ti (Integral time)	i	20
	Td (Derivative time)	d	5
	Default value of Integral Volume	ioF	0
	Heating Control Cycle Setting	HtDd	10
	Process Temperature Offset	tDof	0
INITIAL SETTINGS	Description	Setting	Jet
Press and hold 	Input temperature sensor type	inDt	Dt2
	Temperature unit display selection	tDUn	C
	Upper-limit of temperature range	tD-H	150°
	Lower-limit of temperature range	tD-L	-20
	Control method	Ctrl	DiD
	Heating/Cooling control Selection	S-HC	HEAt
	Alarm 1 type	ALA1	1
	Alarm 2 type	ALA2	1
	Data Format	C-5L	ASCII
	Communication write-in selection	Co5H	on
	Controller Address	C-no	1
	Baud Rate Setting	bD5	9600
	Communication Data Length	LEn	8
	Communication Parity Bit	Prty	nonE
Communication Stop Bit	Stop	1	

Appendix 6: Digital Pressure Gauge

Appendix 6-1: Specifications



AP-30 Series
Two-Color Digital Display Pressure Sensor



TYPE	NEGATIVE PRESSURE		POSITIVE PRESSURE		COMPOUND PRESSURE
	Model	AP-31K (P)	AP-32K (P)	AP-33K (P)	AP-34K
Rated pressure	0 to -29.9 inHg (0 to -101.3 kPa)	0 to 14.50 psi (0 to 100 kPa)	0 to 145.0 psi (0 to 1.000 MPa)	29.9 to -29.9 inHg (101.3 to -101.3 kPa)	
Pressure resistance	72.5 psi	72.5 psi	217.5 psi	72.5 psi	
Type of pressure	Gauge pressure, air or non-corrosive gases				
Fluid type	Air or non-corrosive gases				
Display power	3 1/2-digit, 2-color, 7-segment LED (Character height: 11 mm 0.43")				
Display resolution	0.1 kPa, 1 mmHg, 0.1 inHg, 0.001 bar	0.1 kPa, 0.001 kgf / cm ² , 0.02 psi, 0.001 bar	0.001 MPa 0.01 kgf / cm ² , 0.2 psi, 0.01 bar	0.2 kPa, 2 mmHg, 0.1 inHg, 0.002 bar	
Display range	-15% to +110% of F.S.				
Repetition accuracy	±0.2% of F.S. (5 ms or more)				
Response time (chatter prevention function)	2.5/5/100/500 ms (selectable)				
Control output	NPN open collector: 100 mA max. (40 V max.), Residual voltage: 1 V max. 2-output (N.O./N.C.selectable)				
Analog output	1 to 5 V (Load impedance: 47 kΩ min.)				
Temperature fluctuation for analog output	±2% max. (of F.S.) of detecting pressure at 25 °C (77°F) (0 to 50 °C) (32 to 122 °F)				
Temperature fluctuation for display	±1% max. (of F.S.) of detecting pressure at 25 °C (77°F) (0 to 50 °C) (32 to 122 °F)				
Control output hysteresis	Variable (when hysteresis mode is selected), 0.5% of F.S. in standard mode				
Power supply	12 to 24 VDC ±10%				
Current consumption	50 mA (at 24 V), 90 mA (at 12 V)				
Ambient temperature	0 to 50 °C (32 to 122°F), No condensation / 35 to 85% RH (No condensation)				
Relative humidity	35 to 85% RH (No condensation)				
Vibration	10 to 55 Hz, 1.5 mm 0.06" double amplitude in X, Y, and Z directions, 2 hours respectively				
Material	Front housing: Polyamide, Front panel sheet: PET, Rear housing: Polysulfone, Pressure port: Die-cast zinc, Cable: Oil-proof cabtyre cable				
Weight	Approx.120 g				

Appendix 6-2: Part Names and Functions

AUTO key

In auto-tuning mode, use this key to detect pressure. In measurement mode, press this key for 2 seconds or more to adjust the zero-point.

SET key

Use this key to display or change preset values.

Output indicator 2 (Green LED)

Display unit label

Output indicator 1 (Red LED)

UP/DOWN key

Use these keys to set output modes, or to change preset values or units.

Housing

Hexagonal socket bolt

Rear metal casing (Die-cast zinc)

■ Display unit label

The AP-30 series enables you to select the display units for pressure. Attach the included display unit label for the desired units at the  position in the figure.

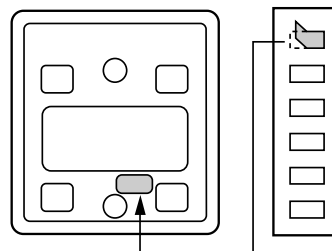

Appendix 6-3: Connections and Input/Output Circuit

■ Connections

- Drive current load

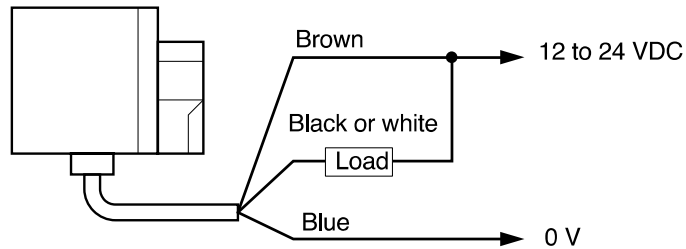

- Input to voltage input equipment

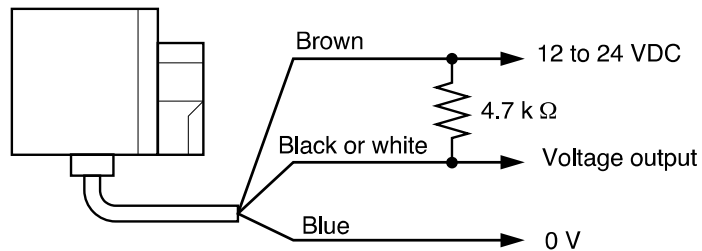

■ Input/output circuit

- Output circuit

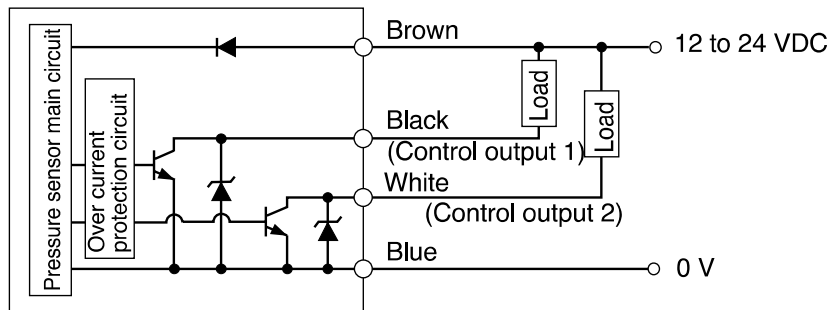

AP-31Z/32Z/33Z/34Z (Z type only)

Input circuit (Zero-shift input)

Zero-shift input resets the display to "0" at the rising edge of the signal.

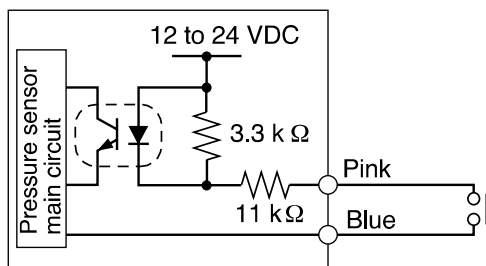

AP-31/32/33/34 (Except for Z type)

Analog output circuit

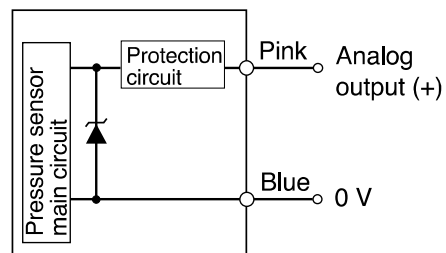

Appendix 6-4: Operation Mode Selection

■ Auto-tuning mode (F-1)

Using the AUTO key, detect the upper limit value (A) and the lower limit value (b). The detection level (C) is automatically set at the midpoint between the two values. (You can finely adjust the preset value C within the range between A and b.)

Control output 1: The sensor turns on when the pressure exceeds the preset value C.

Control output 2: The sensor turns on when the pressure goes outside the stability levels.

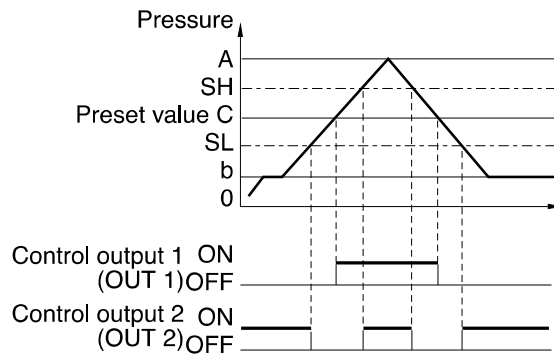

* The stability levels are automatically set as shown in the following calculations.

$$SH = \frac{(A + C)}{2}$$

$$SL = \frac{(C + b)}{2}$$

■ Hysteresis mode (F-2)

Set desired detection level (H) and hysteresis (h) for the detection.

Control output 1: The sensor turns on when the pressure exceeds the preset value H. When the pressure falls by the preset value h, the sensor turns off.

Control output 2: The sensor turns on when the pressure goes outside the hysteresis width (H - h).

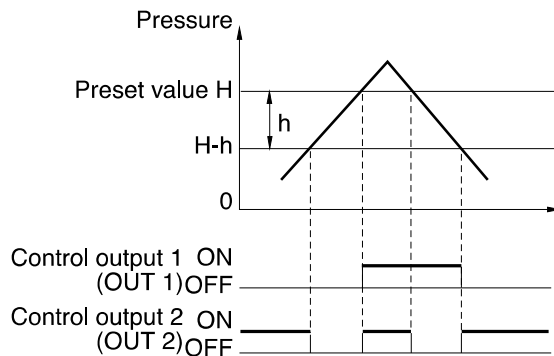

h: Hysteresis width of OUT1

* When h is set to a value close to 0, if pressure fluctuates around the detection point, OUT1 will chatter.

Appendix 6-5: Operation Mode Selection

■ 2-independent mode (F-3)

Set two desired detection points (A and B).

Control output 1: The sensor turns on when the pressure exceeds the preset value A.

Control output 2: The sensor turns on when the pressure exceeds the preset value b.

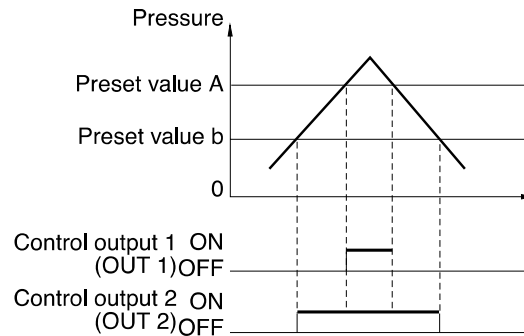

■ Window mode (F-4)

Set desired upper limit value (H) and lower limit value (L).

Control output 1: The sensor turns off when the pressure goes outside of the range between the upper limit value (H) and lower limit value (L).

Control output 2: The sensor turns off when the pressure goes outside of the stability levels.

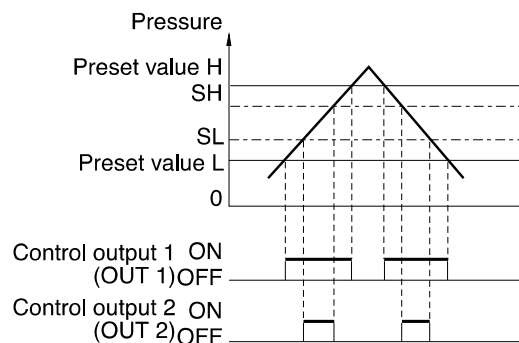

* The stability levels are automatically set as shown in the following calculations.

$$SH = H - \frac{(H - L)}{4}$$

$$SL = L + \frac{(H - L)}{4}$$

Note 1: The above description shows the operation of control outputs 1 and 2 when the output selector switch is set to N.O.

When the output selector switch is set to N.C., the operation of control outputs 1 and 2 is inverted.

Note 2: Except for OUT1 in hysteresis mode, each control output includes an internal hysteresis of 0.5% of F.S.

Appendix 6-6: Adjustment

Measurement mode

Press the button for 3 seconds or more.

Unit Setting

Determine the desired units.
In measurement mode, press **[]** for at least 3 seconds. "----" appears first, and then the current units are displayed. Use **[]** or **[]** to select the desired units. Pressing **[]** completes the unit setting procedure and enters operation mode selection.

Std	AP-31/34: mmHg, AP-32/33: kgf/cm ²	PR	AP-31/32/34: kPa, AP-33: MPa
PS	psi	* When the units are changed, the preset values are automatically converted to appropriate values for the updated units.	

Press the button once.

Operation Mode

Determine the desired operation mode.
(⇨ Refer to "OPERATION MODE SELECTION" on page 2.)

The current operation mode is displayed. Use **[]** or **[]** to select the operation mode. Pressing **[]** completes the operation mode setting procedure and enters N.O./N.C. selection.

F-1	Auto-tuning mode	F-2	Hysteresis mode
F-3	2-independent output mode	F-4	Window mode

Press the button once.

N.O./N.C. Selection

Select N.O. (normally open) or N.C. (normally closed).

The current selection of "no" (normally open) or "nc" (normally closed) is displayed. Use **[]** or **[]** to select the desired mode. Pressing **[]** completes the N.O./N.C. selection procedure and enters the chattering prevention setting.

Press the button once.

Chattering Prevention

Determine the desired response time.

The current response time is displayed. Use **[]** or **[]** to select the response time. Pressing **[]** completes the setting procedure and enters the display color selection.

25	2.5 ms	5	5 ms
100	100 ms	500	500 ms

Press the button once.

Display Color Selection

Determine the desired LED color for numerical value display.

The current color is displayed. Use **[]** or **[]** to select the color. Pressing **[]** completes the setting procedure and returns to the measurement mode.

1- []	Red LED only
2- []	Red/green LED

* The setting is saved in the EEPROM.

Preset Value Input Mode

Determine the preset values.

● **Auto-tuning mode (F-1)**

- In measurement mode with the current measured value displayed, press **[]**. The AP-30 enters the preset value input mode.
- "A" and the current preset value flash alternately.
- Position the target at the desired upper (lower) limit.
- Press **[]** to register the value. The updated value is displayed for 1 second.
- "b" and the current preset value flash alternately.
- Position the target at the desired lower (upper) limit.
- Press **[]** to register the value. The updated value is displayed for 1 second.
- "C" and the calculated preset value C flash alternately. (You can change the C value to any value between A and b using **[]** or **[]**.)
- Press **[]** to register the C value. The setting procedure is completed and the unit returns to measurement mode.

* To confirm the preset value, press **[]** repeatedly.

• **Example of auto-tuning mode setting: Confirmation of work piece pick-up.**

Set the upper limit (A) to the position where the work piece is taken. Set the lower limit (b) to the position where the nozzle becomes open after releasing the work piece. Press **[]** to register the upper and lower limit values. The C value is automatically set to the midpoint between the upper and lower limit values.

Hysteresis Mode (F-2), 2-independent Output Mode (F-3), Window Mode (F-4)

1. In measurement mode with the current measured value displayed, press **[]**. The AP-30 enters the preset value input mode.

2. "H" 1 and the current preset value flash alternately.

3. Use **[]** or **[]** to change the value to the desired value. Press **[]** to register the updated H value.

4. "h" 2 and the current preset value flash alternately.

5. Use **[]** or **[]** to change the value to the desired value. Press **[]** to register the updated h value.

6. "P" 3 and the shift value of the zero-shift adjustment flash alternately.

8. Press **[]** to complete the setting procedure and return to measurement mode.

* To confirm the preset value, press **[]** repeatedly.

Note 1: In hysteresis mode, (h - F.S.) cannot be set to a value greater than H.

Note 2: In window mode, (L + 1% of F.S.) cannot be set to a value greater than H.

* The setting is saved in the EEPROM.

3A6226D

Advanjet HV-2100C Jet Controller Setup and Operation

Page 55 of 64

Appendix 6-7: Other Functions and Error Indications

■ Zero-shift function (Z type only)

The zero-shift function is used to reset the current pressure value to "0" using an external signal input, in order to prevent measurements from being affected by fluctuations in base pressure.

Example: Leakage test

Input a zero-shift value after air supply is completed so that air leakage after a specified time is displayed as a negative value. The AP-30's detection is unaffected by fluctuations in air supply volume.

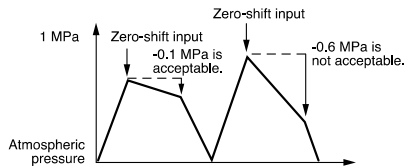

When the power is turned off, the value updated after the zero-shift input (zero-shift value) is lost.

Note 1: The zero-shift function cannot be used in auto-tuning mode.

Note 2: The zero-shift input is effective when the current pressure is between -3% of F.S. and F.S. for a shift of 0 ($P = 0$).

Note 3: If the applied pressure is outside the range of -15% to 110% of the rated pressure, "-FFF" or "FFF" appears.

■ Key protection function

The key protection function is used to lock the front panel key in order to prevent preset values from being accidentally changed.

To enable the key protection function, hold down [A] and press [▲]. "LoC" flashes for 2 seconds and the keys are locked.

To disable the key protection function, again hold down [A] and press [▼]. "uLo" flashes for 2 seconds and the keys are unlocked.

Using the EEPROM, the AP-30 series can retain the preset values even if the power is turned off.

■ Display color selection

You can set the color of the LED display either to the two-color mode which displays the numerical value in green or red according to OUT1, or to the single color mode which always shows the value in red. The two-color display allows you to check the output condition at a glance. (Refer to "ADJUSTMENT" on page 3 for the setting procedure.)

In two-color mode (Regardless of N.O./N.C. selection)

- When OUT1 is turned on: Red
- When OUT1 is turned off: Green

■ Peak-hold/bottom-hold display function

The AP-30 series internally updates the peak-hold and bottom-hold values at all times.

● To display hold values

- While [▲] is held down in measurement mode, the peak-hold value is displayed.
- While [▼] is held down in measurement mode, the bottom-hold value is displayed.

● To reset the peak-hold and bottom-hold values

- Hold down [▲] and press [▼] in measurement mode.

● The peak-hold and bottom-hold values are also reset using the following procedure.

- Turn the power off.
- Press [C] for 3 seconds or more and change any settings.

Note: The hold values cannot be displayed when the front panel keys are locked with the key protection function. Disable the function before displaying the hold values.

■ Analog output function (Except for Z type)

The voltage value according to the pressure value is output.

Model	1 V to 5 V
AP-31	0 to -101.3 kPa
AP-32	0 to +100.0 kPa
AP-33	0 to +1.000 MPa
AP-34	+101.3 to -101.3 kPa

■ Error indications and remedies

Error indication	Problem	Remedy
E	Zero-point adjustment was executed at a pressure of $\pm 5\%$ or more of F.S.	Perform zero-point adjustment at normal atmospheric pressure.
E _C	Overcurrent through OUT1 or 2	Turn power off and adjust the load so that the current is within the rated range.
-FFF, FFF	Applied pressure was outside of the display range.	Adjust the pressure to within the rated range.

■ N.O./N.C. selection

The N.O. or N.C. output can be selected according to the device's control method. When the output status is changed, the color of the numerical value display LED is inverted.

■ Chattering prevention function

The chattering prevention function is used to prevent outputs from chattering by changing the response time. The response time can be selected from 4 settings. When the detection (non-detection) state continues for more than a preset response time, the output is produced.

Appendix 7: Input/Output Connector

Appendix 7-1: HM-2100C I/O Connector

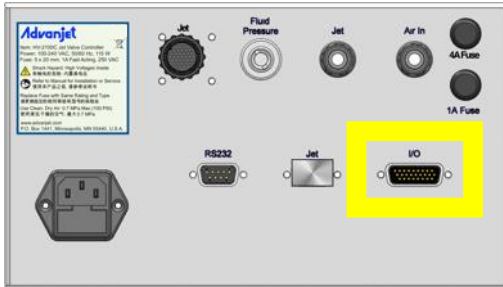

The I/O connector is a 26-pin, high-density, D-SUB, board-mounted receptacle (female sockets). This HD26 I/O connector connects to one type of input circuit and four types of output circuits. The design notes suggest at least one interface circuit on the user's side of each type of input or output.

As a general rule, a good interface should provide level shifting and galvanic isolation between the jet controller and the robot. Galvanic isolation enhances noise immunity between the jet controller and the robot.

For true galvanic isolation when using opto-isolators, it is necessary to use two independent power supplies, one on the input side, and one on the output side. If the input-side ground is connected to the output-side ground, or if there is only one power supply, there is no ground isolation, and the “opto-isolator” is reduced in functionality to a simple level shifter.

Appendix 7-2: HD26 I/O Cable Overview

A standard 5-foot 26-pin I/O cable is supplied with the controller; a mating 5-foot I/O cable is supplied with the jet.

- Pins 1 through 6 of the I/O cable are outputs from the robot to the controller. They can be relay contacts or TTL outputs capable of sinking 2 mA of current.
- Pin 7 outputs a busy status flag from the controller to the robot.
- Pin 8 is an external interrupt used to remotely stop a dispensing program
- Pins 9, 14, and 22 are connected to System Ground
- Pins 10, 15, 16, and 17 are uncommitted pins reserved for future features
- Pins 18 and 23 through 26 are alarms from the heater and pressure sensors
- Pins 19, 20, and 21 are unavailable because the HV-2100C uses electronic fluid pressure regulation.

The following sections describe the pin assignments of the HD26 I/O cable, including the pin name, terminology and specifications, and corresponding schematic diagrams.

Appendix 7-3: I/O Cable Pins 1 – 9

Pin #	Pin Name	Terminology & Specifications
1	Recipe 1 (Input)	<p>DIO 16</p> <ul style="list-style-type: none"> ▪ Digital input 0–24 V DC, ▪ Switching threshold 1.4 V/1.9 V typical. ▪ Pins 1 through 6 of the I/O connector should be driven by outputs from the robot to the Advanjet controller. ▪ Input is normally high. Assert by pulling low. ▪ The I/O is configured for the inputs to be pulled down to GND. When the specific input is triggered, the Advanjet controller will activate the corresponding preprogrammed Recipe # shown <p><i>Refer to Schematic 1: Configurable I/O DIO0-DIO31</i></p>
2	Recipe 2 (Input)	DIO 17
3	Recipe 3 (Input)	DIO 18
4	Recipe 4 (Input)	DIO 19
5	Recipe 5 (Input)	DIO 20
6	Recipe 6 (Input)	DIO 21
7	Busy Flag (Output)	<p>DIO 22</p> <ul style="list-style-type: none"> ▪ Digital output 5 V, 2 mA. ▪ Pin 7 outputs a busy status flag from the Advanjet controller to the robot. ▪ When the Jet is idle, the Busy Flag signal is set to high, then set to low when the Jet is activated. <p><i>Refer to Schematic 1: Configurable I/O DIO0-DIO31</i></p>
8	Stop (Input)	<p>DIO 14</p> <ul style="list-style-type: none"> ▪ Digital input 0–24 V DC, ▪ Switching threshold 1.4 V/1.9 V typical. ▪ Pin 8 is an external interrupt used to remotely stop a dispensing program. All heaters, air pressures, and power to the jet are turned OFF. After a stop actuation, controller power must be cycled by pressing the controller front panel power switch OFF and then ON before operation can be resumed. ▪ Input is normally high. Assert by pulling low. <p><i>Refer to Schematic 1: Configurable I/O DIO0-DIO31</i></p>
9	DGND	<p>GROUND</p> <p><i>Refer to Schematic 1: Configurable I/O DIO0-DIO31</i></p>

Appendix 7-3: I/O Cable Pins 1 – 9, continued

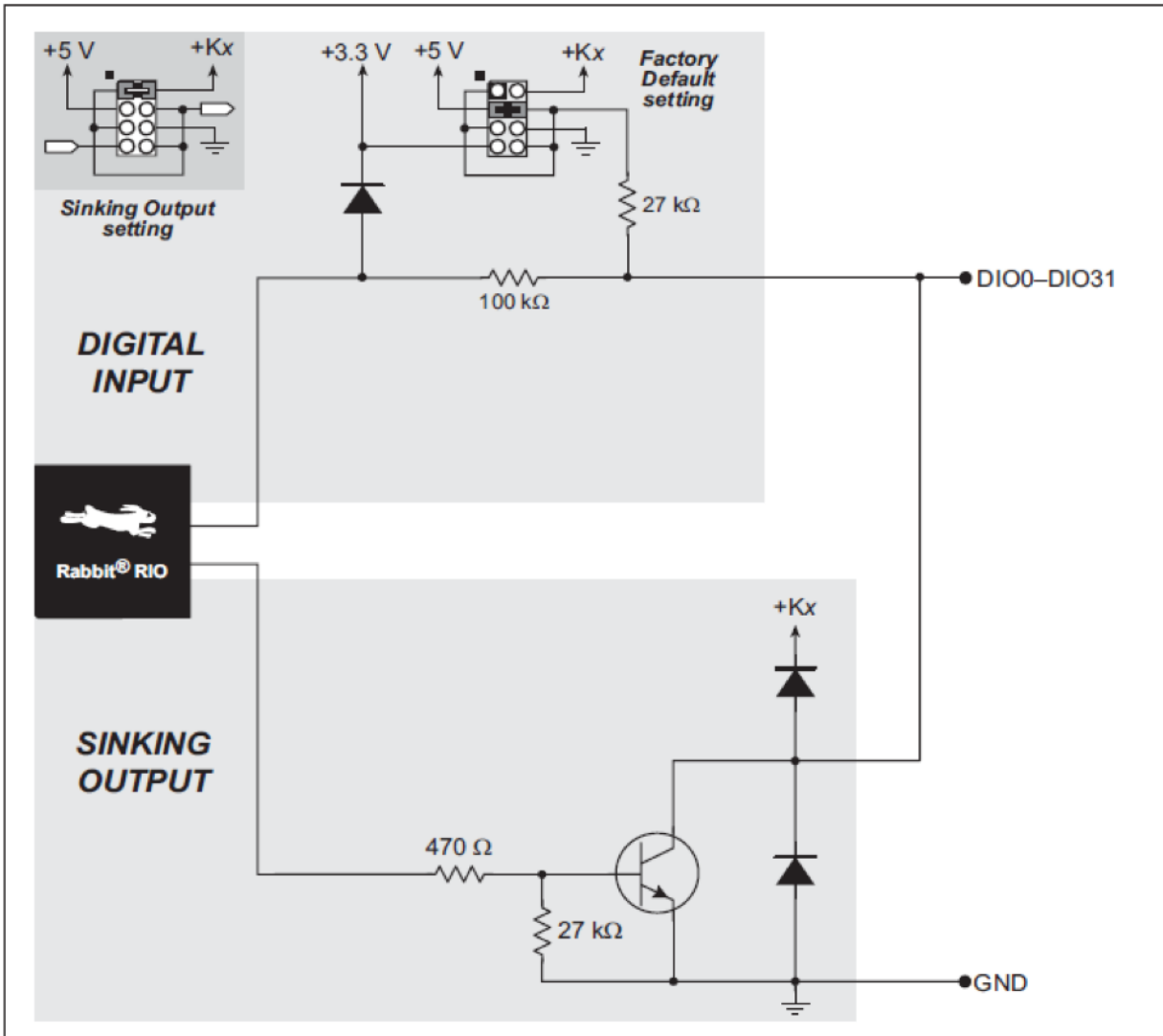

Schematic 1: Configurable I/O DIO0-DIO31

Appendix 7-4: I/O Cable Pins 10 – 17

Pin #	Pin Name	Terminology & Specifications
10	no connection	
11	Analog input	<i>Refer to Schematic 2: Buffered A/D Converter Inputs</i> <ul style="list-style-type: none"> ▪ AIN 5 ▪ 11-bit res. channel, software-selectable ranges unipolar: 1, 2, 2.5, 5, 10, 20 VDC bipolar: ± 1, ± 2, ± 5, ± 10 V DC ▪ 4 channels can be hardware-configured for 4–20 mA ▪ 1 MΩ input impedance, up to 4100 samples/sec
12	+24V Fused	<ul style="list-style-type: none"> ▪ 1 Amp fuse
13	Analog output	<i>Refer to Schematic 3: D/A Converter Outputs</i> <ul style="list-style-type: none"> ▪ AOUT 1 - buffered ▪ 12-bit res. channel, buffered ▪ 0–10 V DC, ± 10 VDC, and 4–20 mA, update rate 12 kHz
14	DGND	GROUND
15	no connection	
16	no connection	
17	no connection	

Appendix 7-4: I/O Cable Pins 10 – 17, continued

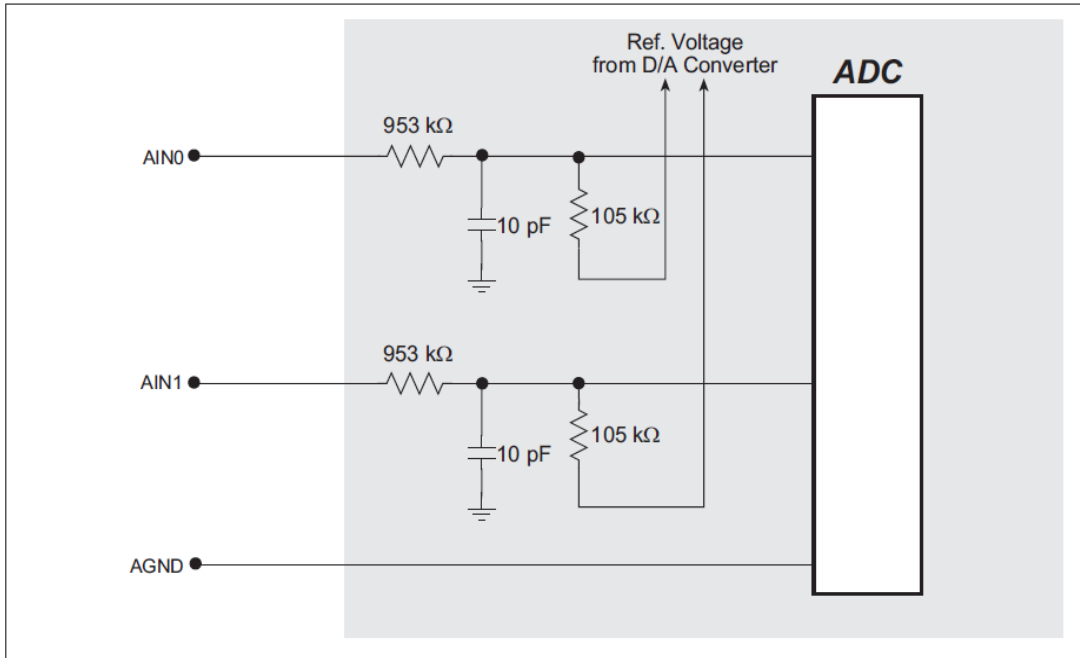

Schematic 2: Buffered A/D Converter Inputs

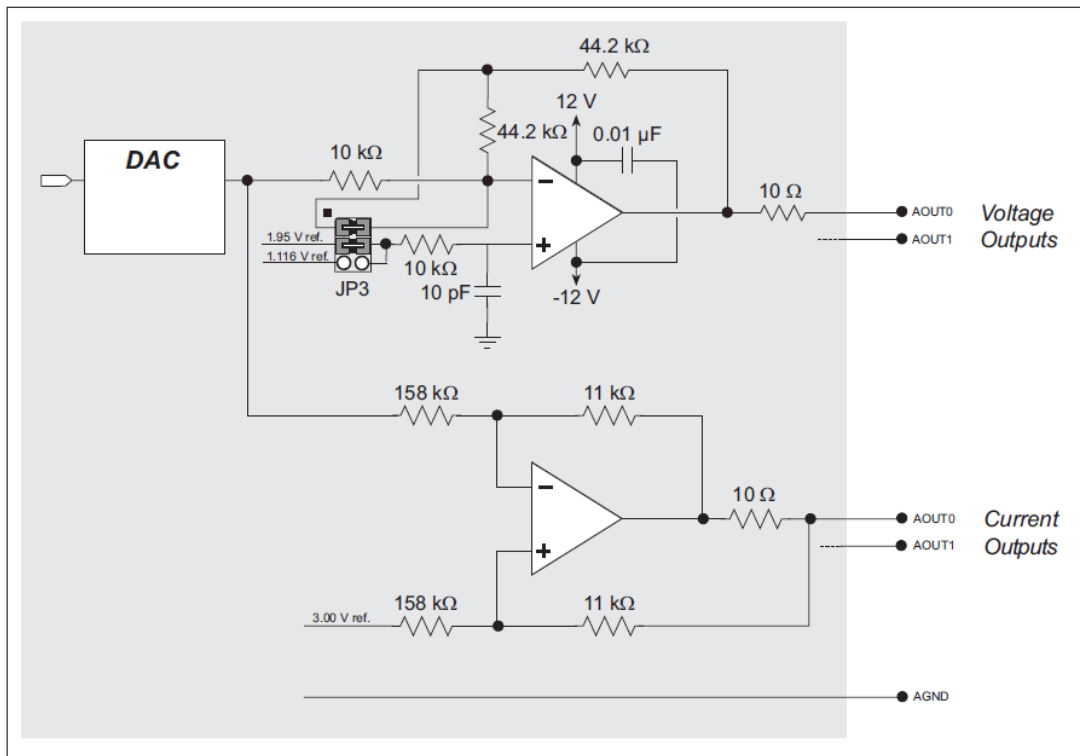

Schematic 3: D/A Converter Outputs

Appendix 7-5: I/O Cable Pins 18 - 26

Pin #	Pin Name	Terminology & Specifications
18	Heater Alarm Common (Output)	The Heater Alarm Common lead connects to one lead of Heater Alarm 1 and one lead of Heater Alarm 2.
19	Fluid Pressure Alarm Common (Output) DGND	HV-2000C only. These pins are not available on the HV-2100C or HM-2600C because these controllers use electronic fluid pressure regulation.
20	Fluid Pressure Alarm Common (Output)	
21	Fluid Pressure Alarm 2 (Output)	
22	Jet Pressure Alarm Common (Output) DGND	GROUND
23	Jet Pressure Alarm 2 (Output)	<i>Refer to Schematic 4: Pressure Alarm Input/Output Circuit</i> <ul style="list-style-type: none"> ▪ Optional alarm. ▪ Not normally programmed for use. ▪ Open collector transistors. User must provide load and power.
24	Jet Pressure Alarm 1 (Output)	
25	Heater Alarm 1 (Output)	<i>Refer to Schematic 5: Temperature Controller Connections</i> <ul style="list-style-type: none"> ▪ Optional alarm. ▪ Not normally programmed for use. ▪ May be configured to create an alarm for twelve different fault conditions. ▪ Single Pole/Single Throw, normally open relay contact, 3A, 250 VAC. ▪ When closed, pin 25 or 26 is connected to pin 18, Heater Alarm Common. One lead of this contact is connected to a lead of Heater Alarm 1 or 2. That common lead is connected to pin 18, Heater Alarm Common.
26	Heater Alarm 2 (Output)	

Appendix 7-5: I/O Cable Pins 18 - 26, continued

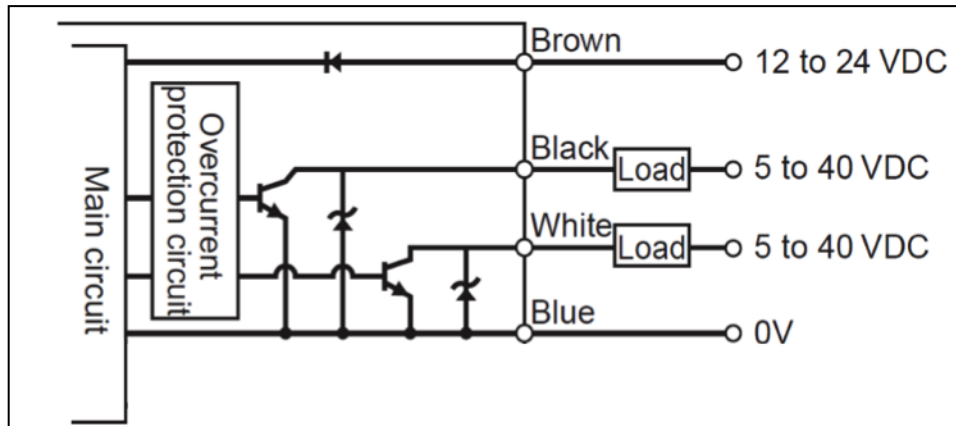

Schematic 4: Pressure Alarm Input/Output Circuit

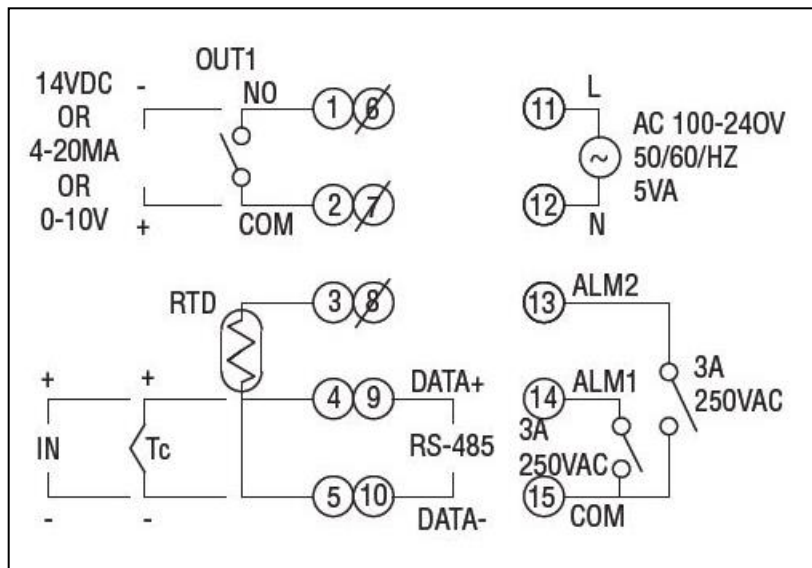

Schematic 5: Temperature Controller Connections

Graco Standard Warranty

Graco warrants all equipment referenced in this document which is manufactured by Graco and bearing its name to be free from defects in material and workmanship on the date of sale to the original purchaser for use. With the exception of any special, extended, or limited warranty published by Graco, Graco will, for a period of twelve months from the date of sale, repair or replace any part of the equipment determined by Graco to be defective. This warranty applies only when the equipment is installed, operated and maintained in accordance with Graco's written recommendations.

This warranty does not cover, and Graco shall not be liable for general wear and tear, or any malfunction, damage or wear caused by faulty installation, misapplication, abrasion, corrosion, inadequate or improper maintenance, negligence, accident, tampering, or substitution of non-Graco component parts. Nor shall Graco be liable for malfunction, damage or wear caused by the incompatibility of Graco equipment with structures, accessories, equipment or materials not supplied by Graco, or the improper design, manufacture, installation, operation or maintenance of structures, accessories, equipment or materials not supplied by Graco.

This warranty is conditioned upon the prepaid return of the equipment claimed to be defective to an authorized Graco distributor for verification of the claimed defect. If the claimed defect is verified, Graco will repair or replace free of charge any defective parts. The equipment will be returned to the original purchaser transportation prepaid. If inspection of the equipment does not disclose any defect in material or workmanship, repairs will be made at a reasonable charge, which charges may include the costs of parts, labor, and transportation.

THIS WARRANTY IS EXCLUSIVE, AND IS IN LIEU OF ANY OTHER WARRANTIES, EXPRESS OR IMPLIED, INCLUDING BUT NOT LIMITED TO WARRANTY OF MERCHANTABILITY OR WARRANTY OF FITNESS FOR A PARTICULAR PURPOSE.

Graco's sole obligation and buyer's sole remedy for any breach of warranty shall be as set forth above. The buyer agrees that no other remedy (including, but not limited to, incidental or consequential damages for lost profits, lost sales, injury to person or property, or any other incidental or consequential loss) shall be available. Any action for breach of warranty must be brought within two (2) years of the date of sale.

GRACO MAKES NO WARRANTY, AND DISCLAIMS ALL IMPLIED WARRANTIES OF MERCHANTABILITY AND FITNESS FOR A PARTICULAR PURPOSE, IN CONNECTION WITH ACCESSORIES, EQUIPMENT, MATERIALS OR COMPONENTS SOLD BUT NOT MANUFACTURED BY GRACO. These items sold, but not manufactured by Graco (such as electric motors, switches, hose, etc.), are subject to the warranty, if any, of their manufacturer. Graco will provide purchaser with reasonable assistance in making any claim for breach of these warranties.

In no event will Graco be liable for indirect, incidental, special or consequential damages resulting from Graco supplying equipment hereunder, or the furnishing, performance, or use of any products or other goods sold hereto, whether due to a breach of contract, breach of warranty, the negligence of Graco, or otherwise.

FOR GRACO CANADA CUSTOMERS

The Parties acknowledge that they have required that the present document, as well as all documents, notices and legal proceedings entered into, given or instituted pursuant hereto or relating directly or indirectly hereto, be drawn up in English. Les parties reconnaissent avoir convenu que la rédaction du présente document sera en Anglais, ainsi que tous documents, avis et procédures judiciaires exécutés, donnés ou intentés, à la suite de ou en rapport, directement ou indirectement, avec les procédures concernées.

Graco Information

For the latest information about Advanjet products, visit www.advanjet.com.

For patent information, see www.graco.com/patents.

For customer service and technical assistance, e-mail info@advanjet.com

TO PLACE AN ORDER, contact orders@advanjet.com

If calling from the US: 800-333-4877

If calling from outside the US: +1-760-294-3392

All written and visual data contained in this document reflects the latest product information available at the time of publication.

Graco reserves the right to make changes at any time without notice.

Original instructions. This manual contains English. MM 3A6226C

Graco Headquarters: Minneapolis

International Offices: Belgium, China, Japan, Korea

GRACO INC. AND SUBSIDIARIES • P.O. BOX 1441 • MINNEAPOLIS MN 55440-1441 • USA

Copyright 2018, Graco Inc. All Graco manufacturing locations are registered to ISO 9001.

www.graco.com

Revision D, September 2019